



Simply Better Connections

## CS1798 / CS17916

8/16-Port USB HDMI KVM Switch  
User Manual

## Compliance Statements

---

### FEDERAL COMMUNICATIONS COMMISSION INTERFERENCE STATEMENT

This equipment has been tested and found to comply with the limits for a Class A digital device, pursuant to Part 15 of the FCC Rules. These limits are designed to provide reasonable protection against harmful interference when the equipment is operated in a commercial environment. This equipment generates, uses, and can radiate radio frequency energy and, if not installed and used in accordance with the instruction manual, may cause harmful interference to radio communications. Operation of this equipment in a residential area is likely to cause harmful interference in which case the user will be required to correct the interference at his own expense.

The device complies with Part 15 of the FCC Rules. Operation is subject to the following two conditions: (1) this device may not cause harmful interference, and (2) this device must accept any interference received, including interference that may cause undesired operation.

### FCC Caution

Any changes or modifications not expressly approved by the party responsible for compliance could void the user's authority to operate this equipment.

### Warning

Operation of this equipment in a residential environment could cause radio interference.

### Achtung

Der Gebrauch dieses Geräts in Wohnumgebung kann Funkstörungen verursachen.



### KCC Statement

유선 제품용 / A 급 기기 (업무용 방송 통신 기기)  
이 기기는 업무용 (A 급) 전자파적합기기로서 판매자 또는 사용자는 이  
점을 주의하시기 바라며, 가정 외의 지역에서 사용하는 것을 목적으로  
합니다.

### **Industry Canada Statement**

This Class A digital apparatus complies with Canadian ICES-003.

## **CAN ICES-003 (A) / NMB-003 (A)**

### **HDMI Trademark Statement**

The terms HDMI, HDMI High-Definition Multimedia Interface, and the HDMI Logo are trademarks or registered trademarks of HDMI Licensing Administrator, Inc.



### **RoHS**

This product is RoHS compliant.

**KVM+ 多電腦切換器類產品**

設備名稱 Equipment Name	8 埠 USB HDMI KVM 多電腦切 換器 / 16 埠 USB HDMI KVM 多電腦切換器			型號 ( 型式 ) Type designa- tion (Type)	CS1798 / CS17916	
單元 Unit	限用物質及其化學符號 Restricted substances and its chemical symbols					
	鉛 Lead (Pb)	汞 Mercury (Hg)	鎘 Cadmium (Cd)	六價鉻 Hexavalent chromium (Cr <sup>+6</sup> )	多溴聯苯 Polybrominated biphenyls (PBB)	多溴二苯醚 Polybrominated diphenyl ethers (PBDE)
電纜線 Cable	-	○	○	○	○	○
印刷電路部件 PCBA	-	○	○	○	○	○
塑膠 / 其他部件 Plastic / Other parts	○	○	○	○	○	○
金屬部件 Metal parts	-	○	○	○	○	○

備考 1. “超出 0.1 wt %”及“超出 0.01 wt %”係指限用物質之百分比含量超出百分比含量基準值。

Note 1: “Exceeding 0.1 wt %” and “exceeding 0.01 wt %” indicate that the percentage content of the restricted substance exceeds the reference percentage value of presence condition.

備考 2. “○”係指該項限用物質之百分比含量未超出百分比含量基準值。

Note 2: “○” indicates that the percentage content of the restricted substance does not exceed the percentage of reference value of presence.

備考 3. “-”係指該項限用物質為排除項目。

Note 3: “-” indicates that the restricted substance corresponds to the exemption.

**製造商：**宏正自動科技股份有限公司

**地址：**新北市汐止區大同路二段 125 號三樓

**警告：**為避免電磁干擾，本產品不應安裝或使用於住宅環境。

**最大操作環境溫度：**50°C

**最大額定電壓：**DC 5V



D33866  
RoHS

## User Information

---

### Online Registration

Be sure to register your product at our online support center:

International	<a href="http://eservice.aten.com">http://eservice.aten.com</a>
---------------	---

### Telephone Support

For telephone support, call this number:

International	886-2-8692-6959
China	86-400-810-0-810
Japan	81-3-5615-5811
Korea	82-2-467-6789
North America	1-888-999-ATEN ext 4988 1-949-428-1111

### User Notice

All information, documentation, and specifications contained in this manual are subject to change without prior notification by the manufacturer. The manufacturer makes no representations or warranties, either expressed or implied, with respect to the contents hereof and specifically disclaims any warranties as to merchantability or fitness for any particular purpose. Any of the manufacturer's software described in this manual is sold or licensed *as is*. Should the programs prove defective following their purchase, the buyer (and not the manufacturer, its distributor, or its dealer), assumes the entire cost of all necessary servicing, repair and any incidental or consequential damages resulting from any defect in the software.

The manufacturer of this system is not responsible for any radio and/or TV interference caused by unauthorized modifications to this device. It is the responsibility of the user to correct such interference.

The manufacturer is not responsible for any damage incurred in the operation of this system if the correct operational voltage setting was not selected prior to operation. PLEASE VERIFY THAT THE VOLTAGE SETTING IS CORRECT BEFORE USE.

## Product Information

---

For information about all ATEN products and how they can help you connect without limits, visit ATEN on the Web or contact an ATEN Authorized Reseller. Visit ATEN on the Web for a list of locations and telephone numbers:

International	<a href="http://www.aten.com">http://www.aten.com</a>
North America	<a href="http://www.aten-usa.com">http://www.aten-usa.com</a>

## Package Contents

---

Check to make sure that all the components are in working order. If you encounter any problem, please contact your dealer.

- ◆ 1 CS1798 / CS17916 8/16-port USB HDMI KVM Switch with Rack Mounting Kit
- ◆ 2 custom USB HDMI KVM cable sets
- ◆ 1 firmware upgrade cable
- ◆ 1 power adapter
- ◆ 1 foot pad set (4 pcs)
- ◆ 1 user instructions

# Contents

---

Compliance Statements . . . . .	ii
User Information . . . . .	v
Online Registration . . . . .	v
Telephone Support . . . . .	v
User Notice . . . . .	v
Product Information . . . . .	vi
Package Contents . . . . .	vii
Contents . . . . .	viii
About this Manual . . . . .	xi
Conventions . . . . .	xii

## **Chapter 1.**

### **Introduction**

Overview . . . . .	1
Features . . . . .	3
Requirements . . . . .	5
Console . . . . .	5
Computers . . . . .	5
Cables . . . . .	6
Operating Systems . . . . .	6
Components . . . . .	7
Front View CS1798 . . . . .	7
Front View CS17916 . . . . .	9
Rear View CS1798 . . . . .	11
Rear View CS17916 . . . . .	12

## **Chapter 2.**

### **Hardware Setup**

Overview . . . . .	13
Installation Types . . . . .	13
Before You Begin . . . . .	13
Stacking and Rack Mounting . . . . .	14
Stacking . . . . .	14
Rack Mounting – Front . . . . .	15
Rack Mounting – Rear . . . . .	17
Single Stage Installation . . . . .	19
Single Stage Installation Diagram . . . . .	20
Two Stage Cascade . . . . .	21
Three Stage Cascade . . . . .	24
Multi-display Installation . . . . .	26
Cable Connections for Multi-display Installation . . . . .	26
Multi-display Installation Diagram . . . . .	28
Grouping Ports into “Vertical” Channels . . . . .	29
Channels Diagram . . . . .	29

**Chapter 3.****Basic Operation**

Hot Plugging . . . . .	31
Hot Plugging KVM Ports . . . . .	31
Hot Plugging Console Ports . . . . .	31
Port Selection . . . . .	32
Manual Port Switching . . . . .	32
Port ID Numbering . . . . .	32
Powering Off and Restarting . . . . .	33

**Chapter 4.****OSD Operation**

OSD Overview . . . . .	35
Manufacturing Number . . . . .	35
OSD Login . . . . .	35
OSD Hotkey . . . . .	35
OSD Main Screen . . . . .	36
OSD Main Screen Headings . . . . .	36
OSD Navigation . . . . .	37
OSD Functions . . . . .	37
F1: GOTO . . . . .	38
F2: LIST . . . . .	38
F3: SET . . . . .	39
F4: ADM . . . . .	41
F5: SKP . . . . .	45
F6: BRC . . . . .	45
F7: SCAN . . . . .	46
F8: LOUT . . . . .	47

**Chapter 5.****Hotkey Operation**

Hotkey Port Control . . . . .	49
Hotkey Setting Mode . . . . .	49
Invoking HSM . . . . .	49
Select the Active Port . . . . .	50
Auto Scan Mode . . . . .	51
Invoking Auto Scan: . . . . .	51
Skip Mode . . . . .	52
Keyboard / Mouse Reset . . . . .	53
Hotkey Beeper Control . . . . .	53
Quick Hotkey Control . . . . .	53
OSD Hotkey Control . . . . .	54
Port OS Control . . . . .	54
Set USB Speed . . . . .	54
Restore Default Values . . . . .	55
USB Reset . . . . .	55

Hotkey Beeper Control .....	55
Video DynaSync .....	55
Mouse Emulation Control .....	56
HSM Summary Table .....	57

**Chapter 6.**

**Keyboard Emulation**

Mac Keyboard .....	59
Sun Keyboard .....	60

**Chapter 7.**

**The Firmware Management Utility**

Introduction .....	61
Downloading the Firmware Upgrade Package .....	61
Preparation .....	62
Starting the Upgrade .....	63
Upgrade Succeeded .....	65
Upgrade Failed .....	65
Firmware Upgrade Recovery .....	66
OSD Configuration Backup/Restore .....	67
Backup .....	67
Restore .....	68
Safety Instructions .....	69
General .....	69
Rack Mounting .....	71
Technical Support .....	72
International .....	72
North America .....	72
CS1798 / CS17916 Connection Tables .....	73
Specifications .....	74
Administrator Login Failure .....	76
Factory Default Hotkeys and Settings .....	77
ATEN Warranty Policy .....	78

## About this Manual

---

This User Manual is provided to help you get the most from your CS1798 / CS17916 system. It covers all aspects of installation, configuration and operation. An overview of the information found in the manual is provided below.

**Chapter 1, Introduction**, introduces you to the CS1798 / CS17916 system. Its purpose, features and benefits are presented, and its front and back panel components are described.

**Chapter 2, Hardware Setup**, describes how to set up your installation. The necessary steps for a basic single stage hookup, three-stage cascade, and multi-display installation are provided.

**Chapter 3, Basic Operation**, explains the fundamental concepts involved in operating the CS1798 / CS17916.

**Chapter 4, OSD Operation**, provides a complete description of the CS1798 / CS17916's OSD (On Screen Display), and how to work with it.

**Chapter 5, Hotkey Operation**, details all of the concepts and procedures involved in the Hotkey operation of your CS1798 / CS17916 installation.

**Chapter 6, Keyboard Emulation**, provides tables that list the PC to Mac and PC to Sun keyboard emulation mappings.

**Chapter 7, The Firmware Management Utility**, explains how to use this utility to upgrade the CS1798 / CS17916's firmware with the latest available versions and perform an OSD configuration backup/restore.

**Appendix**, provides specifications and other technical information regarding the CS1798 / CS17916.

---

### Note:

- ◆ Read this manual thoroughly and follow the installation and operation procedures carefully to prevent any damage to the unit or any connected devices.
- ◆ The product may be updated, with features and functions added, improved or removed since the release of this manual. For an up-to-date user manual, visit <http://www.aten.com/global/en>

## **Conventions**

This manual uses the following conventions:

- |   |  |
|---|--|
| Monospaced  | Indicates text that you should key in.   |
| [ ]   | Indicates keys you should press. For example, [Enter] means to press the <b>Enter</b> key. If keys need to be chorded, they appear together in the same bracket with a plus sign between them: [Ctrl+Alt]. |
| 1.  | Numbered lists represent procedures with sequential steps.   |
| ◆   | Bullet lists provide information, but do not involve sequential steps.   |
| >   | Indicates selecting the option (on a menu or dialog box, for example), that comes next. For example, Start > Run means to open the <i>Start</i> menu, and then select <i>Run</i> .                         |
|  | Indicates critical information.  |

# Chapter 1

## Introduction

### Overview

---

The CS1798 / CS17916 8/16-port USB HDMI KVM Switch is a multi-purpose appliance that consolidates access and control of up to 8/16 HDMI computers from a single USB keyboard, USB mouse, and monitor console. The CS1798 / CS17916 can be cascaded up to three levels – to control up to 512 computers (CS1798); or two levels – up to 256 computers (CS17916) – all from a single console.

In addition the CS1798 / CS17916 features multi-display functionality, which enables the use of standard USB cables to stack up to eight switches in a multi-display installation where each computer is fitted with multiple video cards. Furthermore, the CS1798 / CS17916 comes with ATEN's Video DynaSync™ technology, which optimizes display resolution.

There are three convenient methods to access any computer connected to the installation: (1) using the pushbutton port selection switches located on each unit's front panel; (2) entering *Hotkey* combinations from the keyboard; and (3) selecting from menus provided by the on-screen display (OSD). An Auto Scan feature also permits automatic scanning and monitoring of all computers on the installation, one by one.

The CS1798 / CS17916 provides multimedia keyboard support and is audio enabled. You can listen to the audio output of each computer on two sets of speakers (on a one at-a-time basis).

Setup is fast and easy; simply plug cables into their appropriate ports. There is no software to configure, no installation routines, and no incompatibility problems. Since the CS1798 / CS17916 intercepts keyboard input directly, it works on multiple operating platforms (PC compatible, Mac\*, Sun\*, etc.).

Since a single console manages all of the computers on your installation, a CS1798 / CS17916 KVM switch setup: (1) eliminates the expense of having to purchase a separate keyboard, monitor, and mouse for each computer; (2) saves all the space extra components take up; (3) saves on energy costs; and (4) eliminates the inconvenience and wasted effort involved in constantly moving from one computer to another.

---

**Note:** 1. The CS1798 / CS17916 offers two types of installation – 1) standalone/cascade; and 2) multi-display – that require different

---

cabling setups. Therefore, the functions of both types are not available in one installation.

2. For PC compatible computers. Mac and Sun computers must use the USB cable connections (see *Cables*, page 6).
-

## Features

---

- ◆ One USB console controls up to eight (CS1798) or sixteen (CS17916) HDMI interface computers and two additional USB 2.0 devices
- ◆ HDMI compatible
- ◆ Cascadable to three levels – control up to 512 computers (CS1798); or two levels – up to 256 computers (CS17916)<sup>1</sup>
- ◆ Multi-display feature – stack up to eight CS1798 / CS17916 units and display video from up to eight monitors (dual display / triple display / quad display / multi-display)
- ◆ 2-port USB 2.0 hub built in<sup>2</sup>
- ◆ Computer selection via front panel pushbuttons, hotkeys, and multilingual on-screen display (OSD)
- ◆ Independent switching of KVM and USB focus
- ◆ OSD Backup/Restore feature – enables the administrator to back up the switch's configuration and user profile information
- ◆ Firmware upgradable
- ◆ Video DynaSync™ – exclusive ATEN technology eliminates boot-up display problems and optimizes resolution when switching between ports
- ◆ Superior video quality – supports 480i, 480p, 720p, 1080i, and 1080p (1920 x 1200) @ 60 Hz<sup>3</sup>
- ◆ Supports widescreen resolutions
- ◆ Audio enabled – full bass response provides a rich experience for 2.1 channel surround sound systems
- ◆ Console audio ports on front panel for easy access
- ◆ Auto Scan Mode for monitoring all computers
- ◆ HDCP compatible
- ◆ Multiplatform support – Windows, Linux, Mac, Sun<sup>4</sup>
- ◆ Console mouse port emulation/bypass feature supports most mouse drivers and multifunction mice
- ◆ Complete keyboard emulation for error-free booting

- ◆ Mac/Sun keyboard support and emulation<sup>5</sup>
  - ◆ Multilingual OSD supports English, German, Japanese, Traditional Chinese, Simplified Chinese, Spanish, Russian, and French
  - ◆ Multilingual keyboard mapping – supports English (US), English (UK), French, German, Japanese, Korean, Traditional Chinese, and Spanish
- 

**Note:** 1. CS1798 cascade to CS1798 only.

2. The USB 2.0 hub cannot be accessed through the switch by computers on the second or third level of a cascaded installation.
  3. CS1798 / CS17916 supports the resolution up to 1920 x 1080 @ 60 Hz. Please make sure that the resolution of your connected source is 1920 x 1080 @ 60 Hz or lower in order to avoid compatibility issues.
  4. For PC compatible computers. Mac and Sun computers must be compatible with USB connections.
  5. PC keyboard combinations emulate Mac/Sun keyboards; Mac/Sun keyboards work only with their own computers.
-

## Requirements

---

### Console

- ◆ An HDMI compatible monitor capable of the highest possible resolution that you will be using on any computer in the installation

---

**Note:** For multi-display installations, multiple monitors are required. See *Multi-display Installation*, page 26, for details.

---

- ◆ A USB mouse
- ◆ A USB keyboard
- ◆ Speakers (optional)

### Computers

The following equipment must be available on each computer:

- ◆ An HDMI card

---

**Note:** 1. The quality of the display is affected by the quality of the HDMI display card. For best results, we recommend you purchase a high quality product.

2. For multi-display installations, the computers require multiple HDMI cards. See *Multi-display Installation*, page 26, for details.

---

- ◆ USB Type-A port
- ◆ Speaker ports (optional)

## **Cables**

- ◆ Only custom USB HDMI KVM cable sets, which are specifically designed to work with this switch, may be used to link to the computers. Two cable sets are provided with this package.

---

**Note:** The quality of the display is affected by the quality and length of the cables. If you need additional cable sets, please contact your dealer to purchase the appropriate ones for your switch.

---

Type	Length	Part Number
USB HDMI KVM Cable	1.8 m	2L-7D02UH

- ◆ For multi-display installations, standard USB Type A to USB Type B cables and standard HDMI cables are also required.

---

**Note:** The CS1798 / CS17916 supports speaker ports only. Do not connect the microphone connector from the KVM cable sets.

---

## **Operating Systems**

OS		Version
Windows		2000 / XP / 2003 / 2008 / Vista / 7 / 8 / 10
Linux	RedHat	9.0 or higher
	SuSE	10 / 11.1 or higher
	Debian	3.1 / 4.0
	Ubuntu	7.04 / 7.10
UNIX	AIX	4.3 or higher
	FreeBSD	5.5 or higher
	Sun	Solaris 8 or higher
Novell	Netware	6.0 or higher
Mac		OS 9 to 10.6 (Snow Leopard)

---

**Note:** 1. Supports Linux Kernel 2.6 and higher.

2. The CS1798 / CS17916 has a built-in USB 2.0 hub, and does not support PCs or operating systems that do not support USB 2.0.

---

# Components

## Front View CS1798

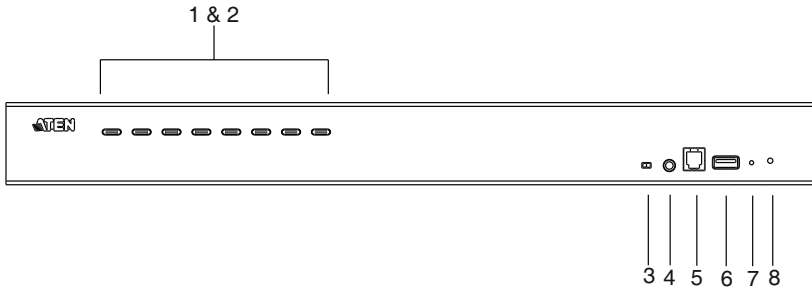

No.	Component	Description
1	port selection pushbuttons	<p>For manual port selection (see <i>Port Selection</i>, page 32, also):</p> <ul style="list-style-type: none"> <li>◆ Press a port selection pushbutton for less than two seconds to bring the KVM, USB hub, and audio focus to the computer attached to its corresponding port.</li> <li>◆ Press a pushbutton for longer than two seconds to bring the KVM and audio focus* to the computer attached to its corresponding port.</li> <li>◆ Press pushbuttons 1 and 2 simultaneously for 2 seconds to start Auto Scan Mode*. See <i>Auto Scan Mode</i>, page 51, for details.</li> <li>◆ Press pushbuttons 7 and 8 simultaneously for 2 seconds to perform a keyboard and mouse reset. See <i>Keyboard / Mouse Reset</i>, page 53, also</li> </ul> <p><b>Note:</b> Enable mouse emulation for independent switching (see page 44).</p>
2	port LEDs	<p>The port LEDs are built into the port selection switches. The left ones are the KVM port LEDs; the right ones are the USB LEDs:</p> <p><b>KVM</b></p> <ul style="list-style-type: none"> <li>◆ Lights DIM ORANGE to indicate that the computer attached to the corresponding port is up and running (On Line).</li> <li>◆ Flashes to indicate that Firmware Upgrade mode is in effect.</li> <li>◆ Changes to BRIGHT ORANGE to indicate that the computer attached to its corresponding port is the one that has the KVM focus (Selected).</li> <li>◆ Flashes to indicate that the computer attached to its corresponding port is being accessed under Auto Scan mode.</li> </ul> <p><b>USB</b></p> <ul style="list-style-type: none"> <li>◆ Lights GREEN to indicate that the computer attached to its corresponding port is the one that has access to the USB peripherals.</li> </ul>

No.	Component	Description
3	firmware upgrade recovery switch	During normal operation and while performing a firmware upgrade, this switch should be in the NORMAL position. If a firmware upgrade operation does not complete successfully, this switch is used to perform a firmware upgrade recovery. See <i>Firmware Upgrade Recovery</i> , page 66, for details.
4	audio port	The cables from your main speakers plug in here. The speakers plugged in here have priority over those in the rear panel.
5	firmware upgrade port	The firmware upgrade cable that transfers the firmware upgrade data from the administrator's computer to the CS1798 / CS17916 plugs into this RJ-11 connector.
6	USB 2.0 hub	USB 2.0 peripherals (printers, scanners, etc.) can plug into this port (this may require an extra power adapter). <b>Note:</b> The USB 2.0 hub cannot be accessed through the switch by computers on the second or third level of a cascaded installation.
7	reset switch	Pressing this switch performs a system reset. When the system is reset, the switch beeps, and the port LEDs flash in succession until the reset is complete. After the reset is complete you can login again. <b>Note:</b> This switch is recessed and must be pushed with a small object, such as the end of a paper clip or a ballpoint pen.
8	power LED	Lights to indicate that the switch is powered up and ready to operate.

---

## Front View CS17916

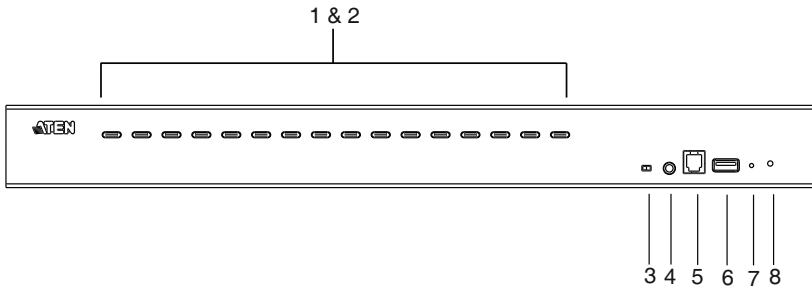

No.	Component	Description
1	port selection pushbuttons	<p>For manual port selection (see <i>Port Selection</i>, page 32, also):</p> <ul style="list-style-type: none"> <li>◆ Press a port selection pushbutton for less than two seconds to bring the KVM, USB hub, and audio focus to the computer attached to its corresponding port.</li> <li>◆ Press a pushbutton for longer than two seconds to bring the KVM and audio focus* to the computer attached to its corresponding port.</li> <li>◆ Press pushbuttons 1 and 2 simultaneously for 2 seconds to start Auto Scan Mode*. See <i>Auto Scan Mode</i>, page 51, for details.</li> <li>◆ Press pushbuttons 15 and 16 simultaneously for 2 seconds to perform a keyboard and mouse reset. See <i>Keyboard / Mouse Reset</i>, page 53, also</li> </ul> <p><b>Note:</b> Enable mouse emulation for independent switching (see page 44).</p>
2	port LEDs	<p>The port LEDs are built into the port selection switches. The left ones are the KVM port LEDs; the right ones are the USB LEDs:</p> <p><b>KVM</b></p> <ul style="list-style-type: none"> <li>◆ Lights DIM ORANGE to indicate that the computer attached to the corresponding port is up and running (On Line).</li> <li>◆ Flashes to indicate that Firmware Upgrade mode is in effect.</li> <li>◆ Changes to BRIGHT ORANGE to indicate that the computer attached to its corresponding port is the one that has the KVM focus (Selected).</li> <li>◆ Flashes to indicate that the computer attached to its corresponding port is being accessed under Auto Scan mode.</li> </ul> <p><b>USB</b></p> <ul style="list-style-type: none"> <li>◆ Lights GREEN to indicate that the computer attached to its corresponding port is the one that has access to the USB peripherals.</li> </ul> <p><b>Note:</b> The USB 2.0 hub cannot be accessed through the switch by computers on the second or third level of a cascaded installation.</p>

No.	Component	Description
3	firmware upgrade recovery switch	During normal operation and while performing a firmware upgrade, this switch should be in the NORMAL position. If a firmware upgrade operation does not complete successfully, this switch is used to perform a firmware upgrade recovery. See <i>Firmware Upgrade Recovery</i> , page 66, for details.
4	audio port	The cables from your main speakers plug in here. The speakers plugged in here have priority over those in the rear panel.
5	firmware upgrade port	The firmware upgrade cable that transfers the firmware upgrade data from the administrator's computer to the CS1798 / CS17916 plugs into this RJ-11 connector.
6	USB 2.0 hub	USB 2.0 peripherals (printers, scanners, etc.) can plug into this port (this may require an extra power adapter). <b>Note:</b> The USB 2.0 hub cannot be accessed through the switch by computers on the second or third level of a cascaded installation.
7	reset switch	Pressing this switch performs a system reset. When the system is reset, the switch beeps, and the port LEDs flash in succession until the reset is complete. After the reset is complete you can login again. <b>Note:</b> This switch is recessed and must be pushed with a small object, such as the end of a paper clip or a ballpoint pen.
8	power LED	Lights to indicate that the switch is powered up and ready to operate.

## Rear View CS1798

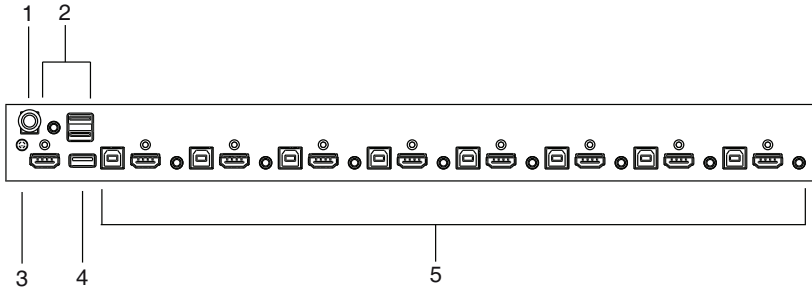

No.	Component	Description
1	power jack	The power adapter cable plugs in here.
2	console port section	The cables from your console HDMI monitor, USB keyboard, USB mouse, and speakers plug in here. Each connector is marked with an appropriate icon to indicate itself.
3	grounding terminal	The grounding wire used to ground the CS1798 / CS17916 attaches here. (Optional)
4	USB 2.0 hub	USB 2.0 peripherals (printers, scanners, etc.) can plug into this port (this may require an extra power adapter). <b>Note:</b> The USB 2.0 hub cannot be accessed through the switch by computers on the second or third level of a cascaded installation.
5	KVM port sections	The cables that link the switch to your computers plug in here. Each KVM port section is comprised of a speaker jack, a USB Type-B socket, and HDMI connector with screw lock.

## Rear View CS17916

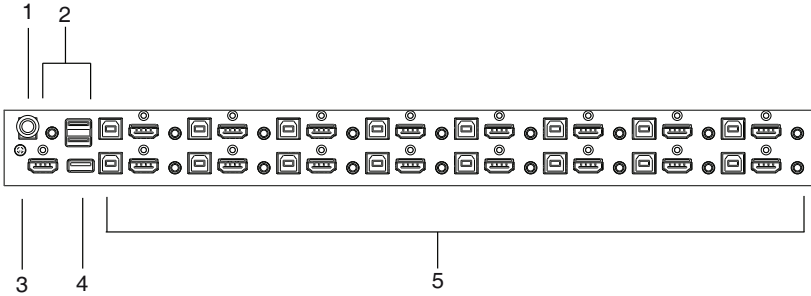

No.	Component	Description
1	power jack	The power adapter cable plugs in here.
2	console port section	The cables from your console HDMI monitor, USB keyboard, USB mouse, and speakers plug in here. Each connector is marked with an appropriate icon to indicate itself.
3	grounding terminal	The grounding wire used to ground the CS1798 / CS17916 attaches here. (Optional)
4	USB 2.0 hub	USB 2.0 peripherals (printers, scanners, etc.) can plug into this port (this may require an extra power adapter). <b>Note:</b> The USB 2.0 hub cannot be accessed through the switch by computers on the second or third level of a cascaded installation.
5	KVM port sections	The cables that link the switch to your computers plug in here. Each KVM port section is comprised of a speaker jack, a USB Type-B socket, and HDMI connector with screw lock.

# Chapter 2

## Hardware Setup

### Overview

---

For convenience and flexibility that allows mixing multiple platforms, the CS1798 / CS17916 design utilizes custom USB HDMI KVM cables that serve as intermediaries between the switch and the connected computers (refer to the installation diagram on page 20).

A separate custom USB HDMI KVM cable is required for each computer connection. The custom KVM cables are listed under *Cables*, on page 6.

Consult your dealer to find out which custom KVM cables best fit your needs.

### Installation Types

The CS1798 / CS17916 offers two types of installation – 1) standalone/cascade; and 2) multi-display – that require different cabling setups. Therefore, the functions of both types are not available in one installation. See the following sections in this chapter for details about the different cabling requirements.

### Before You Begin

---



1. Important safety information regarding the placement of this device is provided on page 69. Please review it before proceeding.
2. To prevent damage to your installation from power surges or static electricity. It is important that all connected devices are properly grounded.
3. Make sure that power to all devices that you will be installing has been turned off. You must unplug the power cords of any computers that have the Keyboard Power On function.
4. Please operate the device with caution when under high environmental temperatures, as the surface of the device may become overheated under such conditions. For instance, the surface temperature of the device may reach 70 °C (158 °F) or higher when the environmental temperature reaches close 50 °C (122 °F).

## Stacking and Rack Mounting

---

The CS1798 / CS17916 can be stacked on the desktop or rack mounted at the front or rear of the rack. The following sections take you through the procedures for each method.

- 
- Note:** 1. Allow at least 5.1 cm on each side for adequate ventilation and 12.7 cm at the rear for power cord and cable clearance.
2. The standard rack mounting kit does not include screws or cage nuts. If you need additional screws or cage nuts, contact your rack dealer.
- 

### Stacking

The CS1798 / CS17916 can be placed on any level surface that can safely support its weight and the weight of the attached cables. Make sure that the surface is clean and free of any materials that can block the exhaust vents or otherwise interfere with normal operation of the switch.

To place the CS1798 / CS17916, or to stack units if you are cascading them, remove the backing material from the bottom of the rubber feet that came with this package, and stick them onto the bottom panel at the corners, as shown in the diagram, below:

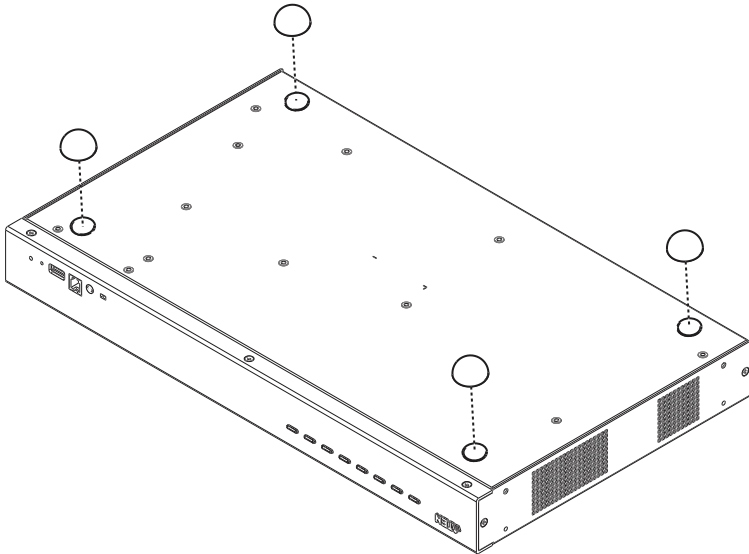

## **Rack Mounting – Front**

1. Remove the screws, one each from the left and right sides of the switch near the front of the switch.

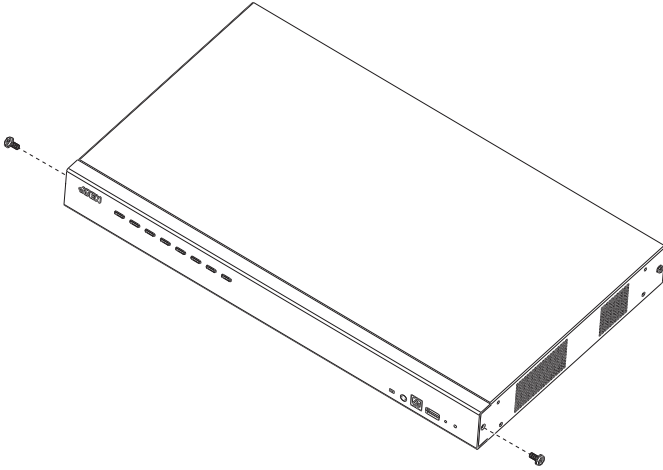

2. Use the M3 x 8 Phillips hex head screws supplied with the rack mount kit to screw the rack mount brackets into the sides near the front of the unit.

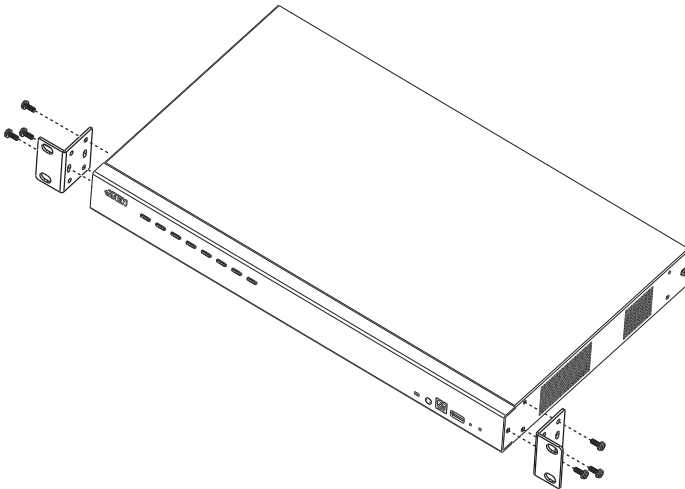

*(Continues on next page.)*

*(Continued from previous page.)*

3. Place the KVM switch in the rack. Position it so that the holes in the rack mount brackets line up with the holes in the rack. Secure the rack mount brackets to the front of the rack.

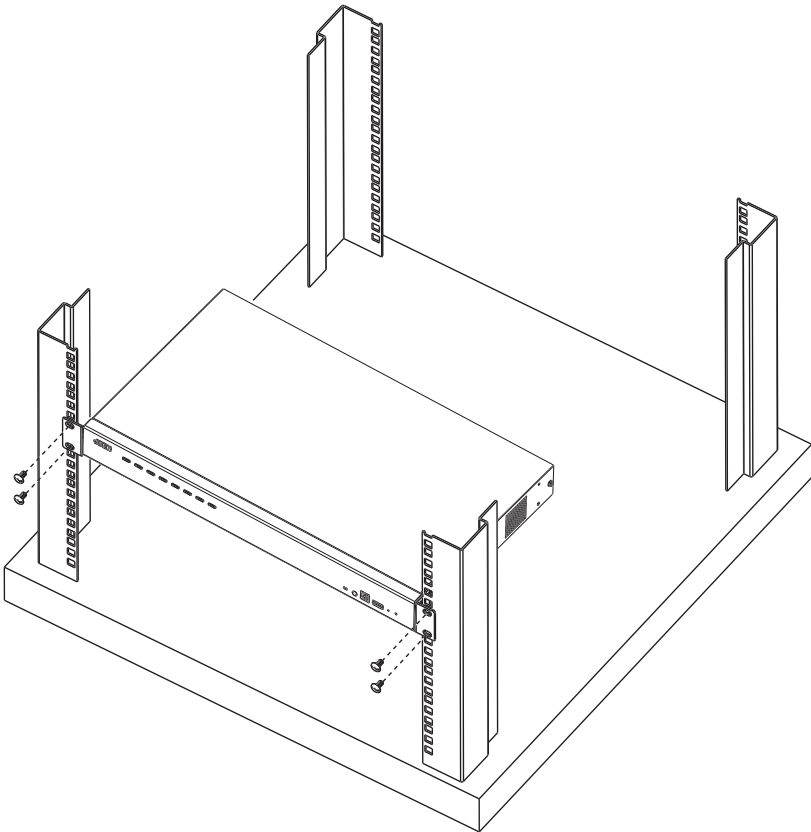

## **Rack Mounting – Rear**

1. Remove the screws, one each from the left and right sides of the switch near the rear of the unit.

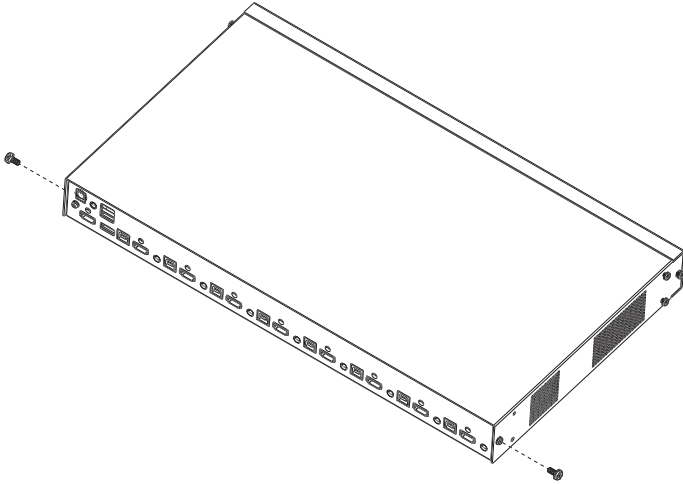

2. Use the M3 x 8 Phillips hex head screws supplied with the rack mount kit to screw the rack mount brackets into the sides near the rear of the unit.

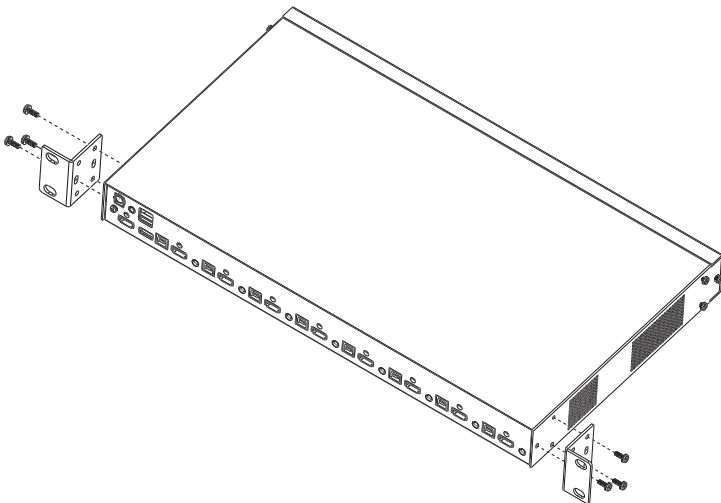

*(Continues on next page.)*

*(Continued from previous page.)*

3. Place the KVM switch in the rack. Position it so that the holes in the rack mount brackets line up with the holes in the rack. Secure the rack mount brackets to the rear of the rack.

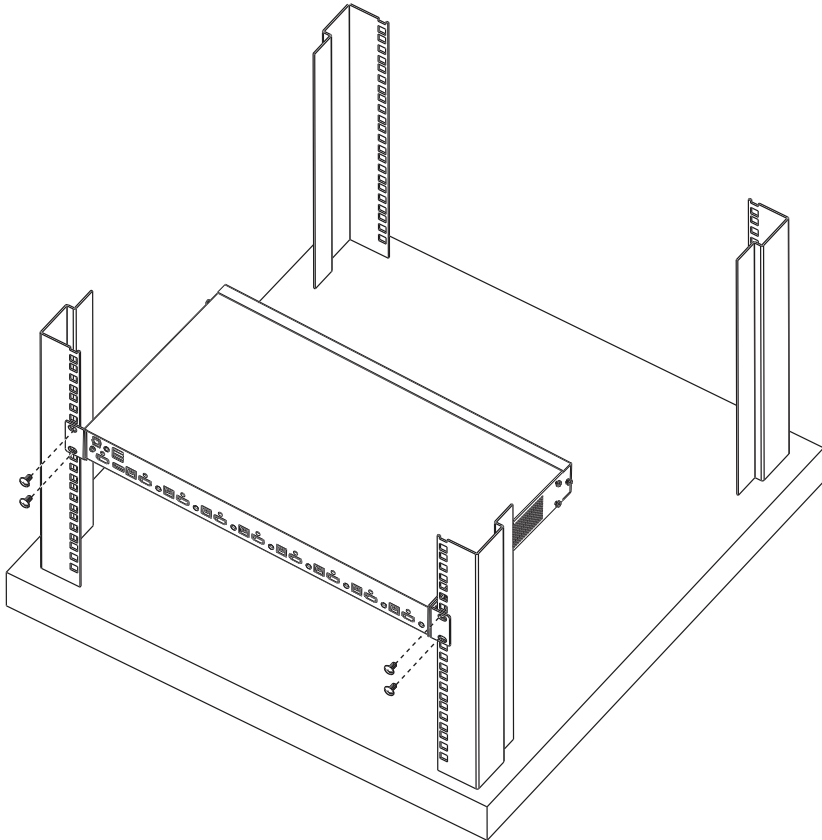

## Single Stage Installation

---

To set up your single stage CS1798 / CS17916 installation, refer to the installation diagram on page 20 (the numbers in the diagrams correspond to the steps, below), and do the following:

1. Plug your USB keyboard and USB mouse into the USB console ports located on the unit's rear panel.
2. Connect your HDMI monitor into the HDMI console port and power on.
3. Plug your main speakers into the speaker jack located on the unit's front panel. The speakers plugged into this port have priority over those plugged into the rear panel.
4. Plug your secondary speakers into the audio port located on the unit's rear panel.
5. Using the custom USB HDMI KVM cable set provided with this package, plug the HDMI connector into any available HDMI socket in the KVM port section of the switch, then plug the accompanying USB and audio connector into their corresponding USB and speaker sockets.

---

**Note:** 1. Verify that all the plugs are in the same KVM port sockets (all in port 1, all in port 2, etc.).

2. The CS1798/CS17916 only supports speaker ports. Do not connect a KVM cable's microphone connector to the speaker ports.

- 
6. At the other end of the cable, plug the USB, video, and speaker cables into their respective ports on the computer.
  7. Plug your USB peripherals into the USB Type-A sockets in the USB hub section.
  8. Plug the power adapter that came with your switch into an AC power source, then plug power adapter cable into the switch's power jack.
  9. Power on the computers.

---

**Note:** Make sure the computers and devices that the CS1798 / CS17916 connects to are also properly grounded.

---

## Single Stage Installation Diagram

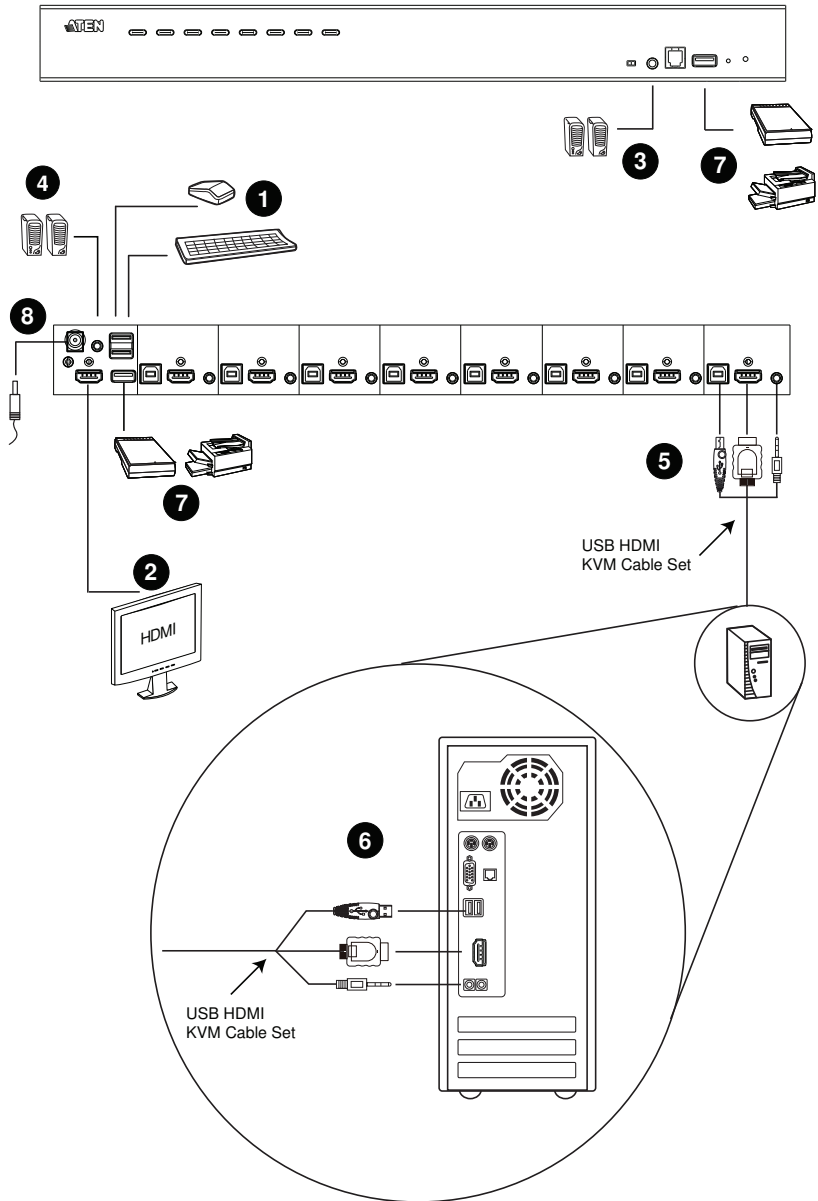

---

## Two Stage Cascade

---

To control even more computers, additional CS1798 / CS17916 units can be cascaded from the KVM ports of the First Stage unit. The cascaded CS1798 / CS17916s that connect back to the First Stage unit are considered Second Stage units. As many as 64 (CS1798) or 256 (CS17916) computers can be controlled in a complete two stage installation. A table showing the relation between the number of computers and the number of units needed to control them is provided on page 73.

To set up a two stage installation, refer to the *Two Stage Installation* diagram on the next page as you do the following:

1. Make sure that power to all the devices you will be connecting up, including all preexisting devices on the installation, have been turned off.
2. Use a custom USB HDMI KVM cable set (see *Cables*, page 6) to connect any available KVM port on the First Stage unit to the console ports of the Second Stage unit.

---

**Note:** Plug the USB Type-A connector into the lower USB (keyboard) port in the console section (they are both marked with a similar icon to remind you of the correct USB port).

---

3. Using another custom USB HDMI KVM cable set (provided with this package), plug the HDMI connector into any available HDMI socket in the KVM port section of the second stage switch, then plug the accompanying USB Type-B, and speaker connectors into their corresponding USB, and speaker sockets.

---

**Note:** 1. Verify that all the plugs are in the same KVM port sockets (all in port 1, all in port 2, etc.), and that each socket is marked with an appropriate icon to indicate itself.

2. The CS1798/CS17916 only supports speaker ports. Do not connect a KVM cable's microphone connector to the speaker ports.
- 

4. At the other end of the cable, plug the USB Type-A, video, and speaker cables into their respective ports on the computer.
5. Repeat steps 3 and 4 for any other computers you are connecting up.
6. For each Second Stage unit, plug the power adapter cable into its power jack, then plug the power adapter into an AC source.

7. Plug the First Stage unit's power adapter cable into its power jack, then plug the power adapter into an AC source.
8. Power on the computers.

---

**Note:** ♦ The Power On sequence requires that all Second Stage units be powered on first. After they are all on, the First Stage units must be powered on next. Only after all the switches have been powered on in this sequence, can the computers be powered on.

- ♦ The USB 2.0 hub cannot be accessed through the switch by computers on the second or third level of a cascaded installation.
  - ♦ Make sure the computers and devices that the CS1798 / CS17916 connects to are also properly grounded.
-

## Two Stage Installation Diagram

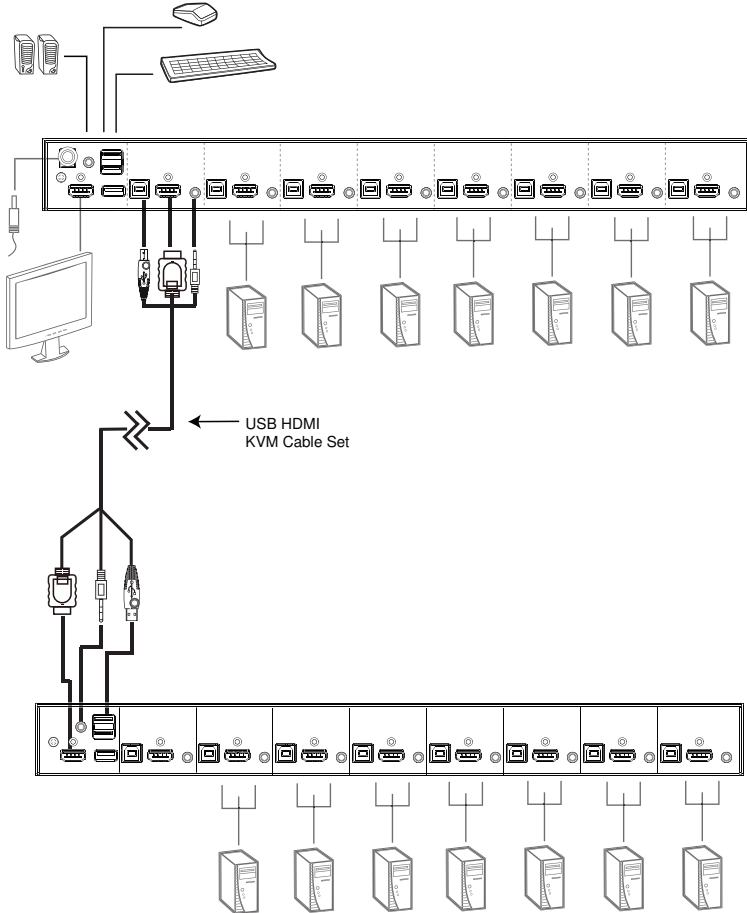

## Three Stage Cascade

---

The procedures for setting up a three stage installation are essentially the same as for a two stage installation. Using the CS1798 in a three stage setup, as many as 512 computers can be controlled in a complete installation. A table showing the relation between the number of computers and the number of switches needed to control them is provided on page 73.

- 
- Note:**
1. The CS1798 cannot cascaded beyond the third level and the CS17916 cannot cascaded beyond the second level.
  2. The CS1798 can only be cascaded with other CS1798 units. The CS17916 (set as the master unit) can cascade with the CS1798 or CS17916.
- 

Once you have finished cabling up (see *Two Stage Cascade*, page 21 if necessary), power up according to the following sequence:

1. For each Third Stage unit, plug the power adapter cable into the switch's power jack; plug the power adapter into an AC source.
2. For each Second Stage unit, plug the power adapter cable into the switch's power jack; plug the power adapter into an AC source.
3. Plug the First Stage unit's power adapter cable into its power jack, then plug the power adapter into an AC source.
4. Power on the computers.

- 
- Note:** ♦ The Power On sequence requires that all Third Stage units be powered on first. After they are all on, the Second Stage units must be powered on next. After the Second Stage units are on, the First Stage units must be powered on last. Only after all the switches have been powered on in this sequence, can the computers be powered on.
- ♦ The USB 2.0 hub cannot be accessed through the switch by computers on the second or third level of a cascaded installation.
  - ♦ Make sure the computers and devices that the CS1798 / CS17916 connects to are also properly grounded.
-

## Three Stage Installation Diagram

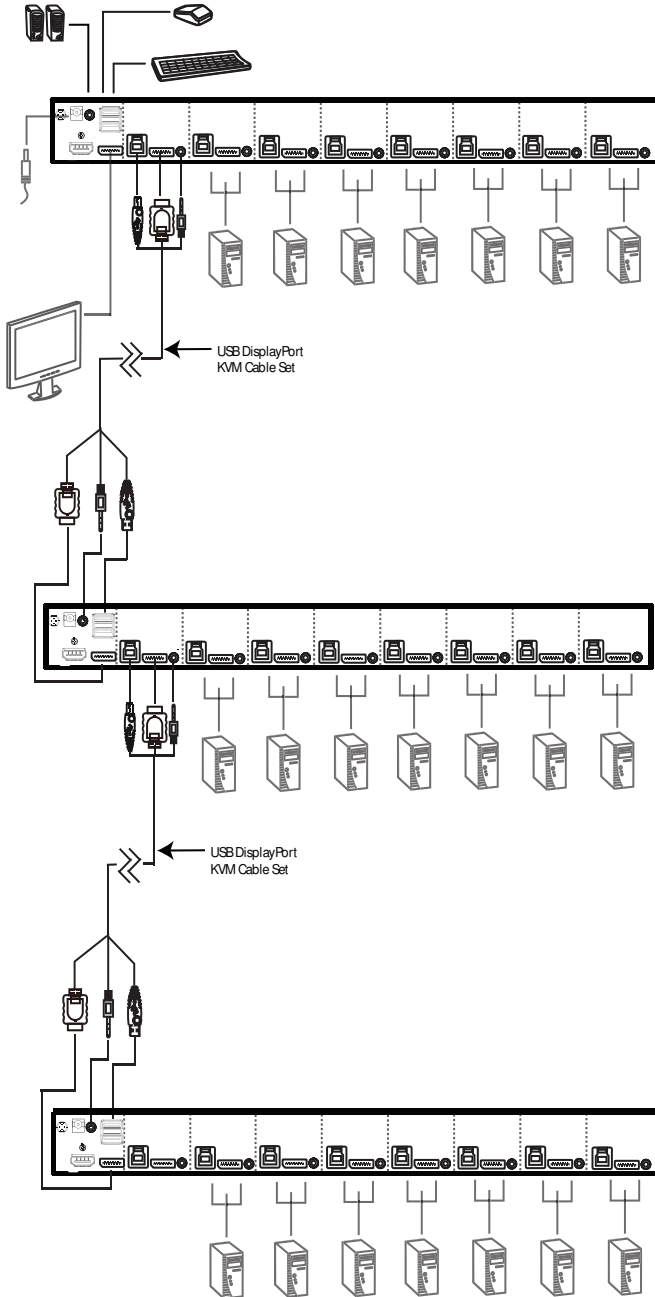

## Multi-display Installation

---

The CS1798 / CS17916's multi-display feature allows you to stack two, three, four, or up to 8 units in a dual/triple/quad-display/multi-display installation to control up to seven (CS1798) or fifteen (CS17916) computers at once. This installation requires slightly different cabling than the standard cascade and offers an extra level of switching flexibility for multiple-monitor installations where each computer is fitted with multiple video cards.

---

**Note:** In a Multi-display installation, the CS1798 can only be connected to CS1798 units, and the CS17916 can only be connected to CS17916 units.

---

### Cable Connections for Multi-display Installation

To set up your multi-display installation, refer to the installation diagram on the next page (the numbers in the diagrams correspond to the steps, below), and do the following:

1. Use a standard USB Type A-to-USB Type B cable to connect the port 8 USB Type-B port on the first stage unit to the USB Type-A port in the console section of the second switch.

---

**Note:** Port 8 is reserved to connect the units in a multi-display installation, so up to seven (CS1798) or fifteen (CS17916) computers can be attached, using KVM ports 1–7 (CS1798) or ports 1–7/9–16 (CS17916).

---

2. Use HDMI cables to connect the HDMI KVM port on the second CS1798 / CS17916 unit to the second video-in port on the computers.

---

**Note:** Only HDMI video cables are necessary – the other ports in the KVM section are not required in this installation.

---

3. Connect a display to the console section of the second switch.
4. Repeat steps 1–3 for any additional units, up to a total of 8 switches.
5. Connect the cables for the first switch. See *Single Stage Installation*, page 19 for full details. All video, audio and peripheral devices must be connected to the first switch.
6. Power up the CS1798 / CS17916 units, starting with the first switch, and then power on the computers.

**Note:** Make sure the computers and devices that the CS1798 / CS17916 connects to are also properly grounded.

---

## Multi-display Installation Diagram

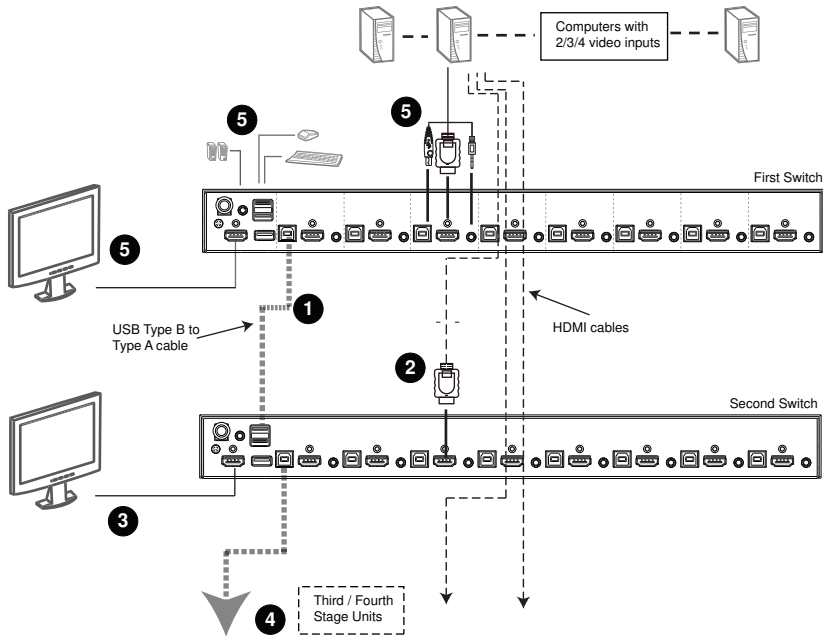

## Grouping Ports into “Vertical” Channels

Once the cables have been connected and multi-display mode has been selected in the OSD, the CS1798 / CS17916 auto-detects the channels and displaying modes. Users can then assign them a channel number as the port name (the channels are represented by the vertical columns in the diagram below). So, all the Port 1s become Channel 1, all the Port 2s become Channel 2, ... , and all the Port 7s become Channel 7. The ports will all be switched at the same time, channel by channel.

Depending on the number of stages in your stack, a CS1798 / CS17916 installation offers dual display (two stages), triple display (three stages), quad display (four stages) or multi-display (up to 8 stages) scenarios. For reference purposes, the example shows a four-stage installation with quad display functionality.

**Note:** Only one HDMI video signal can be displayed at a time, depending on the configuration of the CS1798 / CS17916 unit on the first switch.

### Channels Diagram

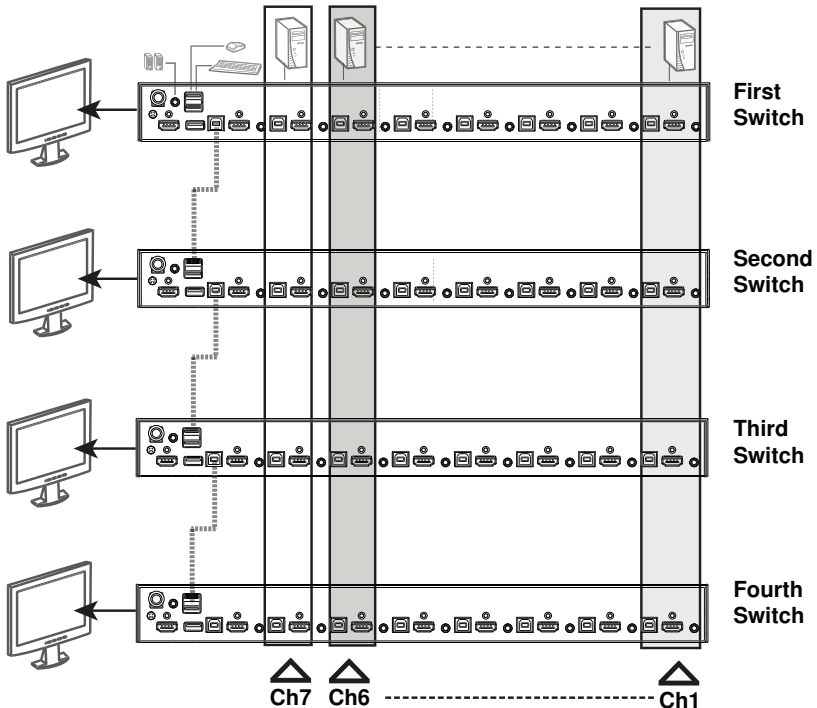

This Page Intentionally Left Blank

# Chapter 3

## Basic Operation

### Hot Plugging

---

The CS1798 / CS17916 supports *hot plugging* – components can be removed and added back into the installation by unplugging their cables from the ports without the need to shut the unit down. In order for hot plugging to work properly, the procedures described below must be followed:

#### Hot Plugging KVM Ports

In order for the OSD menus to correspond to KVM port changes, you must manually reconfigure the OSD to reflect the new port information. See the *F3 SET* (page 39) and *F4 ADM* (page 41), functions for details.

---

**Note:** If the computer's operating system does not support hot plugging, this function may not work properly.

---

#### Hot Plugging Console Ports

The keyboard, monitor, and mouse can all be hot plugged. When hot plugging the mouse:

- ◆ You may unplug and replug the mouse (to reset the mouse, for example), as long as you use the same mouse.
- ◆ If you plug in a different mouse, all the computers on the installation must be shut down for 10 seconds, then restarted following the power up sequence described under Steps 6, 7, and 8 under *Two Stage Cascade*, page 21

---

**Note:** If, after hot plugging there is no response to keyboard and/or mouse input, perform a *Keyboard and Mouse Reset* by simultaneously pressing the 7 and 8 (CS1798) or 15 and 16 (CS17916) front panel pushbuttons.

---

## Port Selection

---

The CS1798 / CS17916 provides three port selection methods to access the computers on the installation: Manual, an OSD (on-screen display) menu system, and Hotkeys. See Chapter 4, *OSD Operation* and Chapter 5, *Hotkey Operation* for more information.

### **Manual Port Switching**

Use the front panel pushbutton switches to manually switch to a port.

## Port ID Numbering

---

Each port on a CS1798 / CS17916 installation is assigned a unique *Port ID*. You can directly access any computer on any level of the installation by specifying the Port ID that the computer is connected to – either with the OSD (see *OSD Operation*, page 35), or with the Hotkey port selection method (see *Hotkey Operation*, page 49).

- ♦ A computer attached to a master unit has a two digit Port ID (from 01–08 for the CS1798, or 01–16 for the CS17916) that corresponds to the KVM port number that it is connected to.
- ♦ A computer attached to a slave unit has a four digit Port ID.

The first two digits represent the KVM port number on the master and the second two digits represent the KVM port number on the slave unit that the computer is connected to. For example, a Port ID of 02–08 would refer to a computer that is connected to KVM port 8 of a slave unit that links back to KVM port 2 of the master unit.

## Powering Off and Restarting

---

If it becomes necessary to power off a CS1798 / CS17916, do the following before restarting it:

1. Unplug the CS1798 / CS17916 from its power source.
2. Shut down all the computers that are attached to it.

---

**Note:** Unplug the power cords of any computers that have the *Keyboard Power On* function. Otherwise, the CS1798 / CS17916 will still receive power from the computers.

---

3. Wait 10 seconds, then plug the CS1798 / CS17916 back in.
4. Power on the computers.

---

**Note:** If there are stations cascaded down from the master CS1798 / CS17916, all the cascaded stations and the computers attached to them must be shut down as well.

---

This Page Intentionally Left Blank

# Chapter 4

## OSD Operation

### **OSD Overview**

---

The on-screen display (OSD) is a mouse and keyboard enabled, menu driven method to handle computer control and switching operations. All procedures start from the OSD main screen.

### **Manufacturing Number**

The “MFG Number” (Manufacturing Number) is an internal serial number used by ATEN’s factory and technical support staff to identify products. This number does not affect products’ warranty. If your product requires after-sales services, you may provide the MFG Number to ATEN’s sales or technical support staff to identify the product and model number.

### **OSD Login**

The OSD incorporates a two level (administrator / user) password system. Before the OSD main screen displays, a login screen appears requiring a password. If this is the first time that the OSD is used, or if the password function has not been set, simply press **[Enter]**. The OSD main screen displays in administrator mode. In this mode, you have administrator privileges, with access to all administrator and user functions, and can set up operations (including password authorization) as you like. If the password function has been set, you must provide an appropriate administrator/user password in order to access the OSD.

### **OSD Hotkey**

You can display the OSD on the console monitor while also viewing the display of any port on the CS1798 / CS17916 by pressing the **[Scroll Lock]** key twice.

---

**Note:** You can optionally change the OSD hotkey to the Ctrl key, in which case you would press **[Ctrl]** twice (see *OSD HOTKEY*, page 39). With this method, you must press the same **[Ctrl]** key.

---

## OSD Main Screen

When you invoke the OSD, a screen similar to the one below appears:



- Note:**
1. The diagram depicts the administrator's main screen. The user main screen does not show the **F4** and **F6** functions, since these are reserved for the administrator and can't be accessed by users.
  2. The OSD always starts in list view, with the highlight bar at the same position it was in the last time it was closed.
  3. Only the ports that have been set accessible by the administrator for the current logged in user are visible (see *SET ACCESSIBLE PORTS*, page 41).
  4. If the port list is collapsed, click on a switch number, or move the highlight bar to it then press the right arrow key to expand the list. Similarly, to collapse a switch's port list, click on the switch number, or move the highlight bar to it then press the left arrow key to collapse the list.

## OSD Main Screen Headings

PN	This column lists the port ID numbers for all the KVM ports on the installation. The simplest method to access a particular computer is move the highlight bar to it, then press <b>Enter</b> .
QV	If a port has selected for quick view scanning (see <i>SET QUICK VIEW PORTS</i> , page 43), an arrowhead displays in this column.
	The computers that are powered on and are online have a sun symbol in this column.
NAME	If a port has been given a name (see <i>EDIT PORT NAMES</i> , page 42), its name appears in this column.

## **OSD Navigation**

- ◆ To dismiss the menu, and deactivate OSD, click the **X** at the upper right corner of the OSD window; or press **[Esc]**.
- ◆ To log out, click **F8** at the top of the main screen, or press **[F8]**.
- ◆ To move up or down through the list one line at a time, click the up and down triangle symbols (**▲▼**) or use the up and down arrow keys. If there are more list entries than what can appear on the main screen, the screen will scroll.
- ◆ To move up or down through the list one screen at a time, click the up and down arrow symbols (**↑↓**), or use the [Pg Up] and [Pg Dn] keys. If there are more list entries than what can appear on the main screen, the screen will scroll.
- ◆ To activate a port, double-click it, or move the highlight bar to it then press **[Enter]**.
- ◆ After executing any action, you automatically go back to the menu one level above.

## **OSD Functions**

---

OSD functions are used to configure and control the OSD. For example, you can rapidly switch to any port, scan selected ports, limit the list you wish to view, designate a port as a quick view port, create or edit a port name, or make OSD setting adjustments.

To access an OSD function:

1. Either click a function key field at the top of the main screen, or press a function key on the keyboard.
2. In the submenus that appear make your choice either by double-clicking it, or moving the highlight bar to it, then pressing **[Enter]**.
3. Press **[Esc]** to return to the previous menu level.

## **F1: GOTO**

Clicking the **F1** field or pressing **[F1]** activates the GOTO function. GOTO allows you to switch directly to a port either by keying in the port's *Name*, or its *Port ID*. Enable mouse emulation for independent switching (see page 42), for this function to work.

- ♦ To use the name method, key in **1**; key in the port's *Name*; then press **[Enter]** to switch KVM, Audio and USB focus; or **[Spacebar]** to switch KVM and Audio only.
- ♦ To use the port ID method, key in **2**; key in the *Port ID*; then press **[Enter]** to switch KVM, Audio and USB focus; or **[Spacebar]** to switch KVM and Audio only.

---

**Note:** You can key in a partial name or port ID. In that case, the screen will show all the computers that the user has *View* rights to (see *SET ACCESSIBLE PORTS*, page 41), that match the name or port ID pattern, regardless of the current list settings (see *F2 LIST*, page 38, for details).

---

To return to the OSD main screen without making a choice, press **[Esc]**.

## **F2: LIST**

This function lets you broaden or narrow the scope of which ports the OSD displays on the main screen. The submenu choices and their meanings are given in the table below.

<b>Choice</b>	<b>Meaning</b>
ALL	Lists all of the ports on the installation that have been set accessible by the administrator for the current logged in user.
QUICK VIEW	Lists only the ports that have been selected as quick view ports (see <i>SET QUICK VIEW PORTS</i> , page 43).
POWERED ON	Lists only the ports that have their attached computers powered on.
QUICK VIEW + POWERED ON	Lists only the ports that have been selected as quick view ports (see <i>SET QUICK VIEW PORTS</i> , page 43), and that have their attached computers powered on.

Move the highlight bar to the choice you want, then press **[Enter]**. An icon appears before the choice to indicate that it is the currently selected one.

### **F3: SET**

This function allows the administrator and each user to set up his own working environment. A separate profile for each is stored by the OSD and is activated according to the username that was provided during login.

To change a setting:

1. Double-click it; or move the highlight bar to it, then press **[Enter]**.
2. After you select an item, a submenu with further choices appears. To make a selection, either double-click it; or move the highlight bar to it, then press **[Enter]**. An icon appears before the selected choice to indicate which one it is. The settings are explained in the following table:

<b>Setting</b>	<b>Function</b>
OSD HOTKEY	<p>Selects which hotkey activates the OSD function:</p> <p><b>[Scroll Lock] [Scroll Lock]</b> or <b>[Ctrl] [Ctrl]</b>.</p> <p>Since the [Ctrl] key combination may conflict with programs running on the computers, the default is the [Scroll Lock] combination.</p>
PORT ID DISPLAY POSITION	<p>Allows each user to customize the position where the port ID appears on the screen. The default is the upper left corner, but users can choose to have it appear anywhere on the screen.</p> <p>Use the mouse or the arrow keys plus Pg Up, Pg Dn, Home, End, and 5 (on the numeric keypad with Num Lock off), to position the port ID display, then double-click or press <b>[Enter]</b> to lock the position and return to the Set submenu.</p>
PORT ID DISPLAY DURATION	<p>Determines how long a port ID displays on the monitor after a port change has taken place. The choices are: <b>3 Seconds</b> (default) and <b>Always Off</b>.</p>
PORT ID DISPLAY MODE	<p>Selects how the port ID is displayed: the port number plus the port name (<b>PORT NUMBER + PORT NAME</b>) (default); the port number alone (<b>PORT NUMBER</b>); or the port name alone (<b>PORT NAME</b>).</p>
SCAN DURATION	<p>Determines how long the focus dwells on each port as it cycles through the selected ports in Auto Scan mode (see <i>F7 SCAN</i>, page 46). Key in a value from 1–255 seconds, then press <b>[Enter]</b>. Default is 5 seconds; a setting of 0 disables the SCAN function.</p> <p><b>Note:</b> Enable mouse emulation for auto scan to work (see page 44).</p>

*(Continues on next page.)*

*(Continued from previous page.)*

Setting	Function
SCAN-SKIP MODE	<p>Selects which computers will be accessed under skip mode (see <i>F5: SKP</i>, page 45), and Auto Scan mode (see <i>F7: SCAN</i>, page 46. Choices are:</p> <p><b>ALL</b> - All the ports which have been set accessible (see <i>SET ACCESSIBLE PORTS</i>, page 41);</p> <p><b>QUICK VIEW</b> - Only those ports which have been set accessible and have been selected as quick view ports (see <i>SET QUICK VIEW PORTS</i>, page 43);</p> <p><b>POWERED ON</b> - Only those ports which have been set accessible and are powered on;</p> <p><b>QUICK VIEW + POWERED ON</b> - Only those ports which have been set accessible and have been selected as quick view ports and are powered on. The default is ALL.</p> <p><b>Note:</b> The quick view choices only show up on the administrator's screen, since only he has <i>Quick View</i> setting rights (see <i>SET QUICK VIEW PORTS</i>, page 43). Enable mouse emulation for scan-skip mode to work (see page 44).</p>
SCREEN BLANKER	<p>If there is no input from the console for the amount of time set with this function, the screen is blanked. Key in a value from 1–30 minutes, then press <b>[Enter]</b>. The default setting of 0 disables this function.</p>
HOTKEY COMMAND MODE	<p>Enables / disables the hotkey command function in case a conflict with programs running on the computers occurs.</p>
HOTKEY	<p>Sets the keyboard shortcut for invoking <i>Hotkey Mode</i> (see <i>Hotkey Setting Mode</i>, page 49). Choices are: <b>NUM LOCK + -</b> (minus) (default), and <b>CTRL + F12</b>.</p>
OSD LANGUAGE	<p>Sets the language used in the OSD. Choices are: English (default), German, Japanese, Simplified Chinese, Traditional Chinese, Spanish, French, and Russian.</p>

## **F4: ADM**

F4 is an administrator only function. It allows the administrator to configure and control the overall operation of the OSD. To change a setting double-click it, or use the up and down arrow keys to move the highlight bar to it then press **[Enter]**.

After you select an item, a submenu with further choices to select from appears. Double-click an item, or move the highlight bar to it then press **[Enter]**. An icon appears before the selected item so that you know which one it is. The settings are explained in the following table:

<b>Setting</b>	<b>Function</b>
SET USER LOGIN	<p>This function is used to set usernames and passwords for the administrator and users:</p> <ol style="list-style-type: none"> <li>1. Usernames and passwords for one administrator and four users can be set.</li> <li>2. After you select the administrator field or one of the user fields, a screen that allows you to key in the username and password appears. Usernames and passwords can be from 1 to 16 characters long and can consist of any combination of letters and numbers (A–Z, 0–9) and some additional keys (* ( ) + : - , ? . / space).</li> <li>3. For each individual, key in the username and password, confirm the password, then press <b>[Enter]</b>.</li> <li>4. To modify or delete a previous username and/or password, use the backspace key to erase individual letters or numbers. Press <b>[Enter]</b> when done.</li> </ol> <p><b>Note:</b> Usernames and passwords are not case sensitive. Usernames are displayed in capital letters in the OSD.</p>
SET ACCESSIBLE PORTS	<p>This function allows the administrator to define user access to the computers on the installation on a port-by-port basis.</p> <p>For each user, select the target port; then press the <b>[Spacebar]</b> to cycle through the choices: <b>F</b> (full access), <b>V</b> (view only), or blank. Repeat until all access rights have been set, then press <b>[Enter]</b>. The default is <b>F</b> for all users on all ports.</p> <p><b>Note:</b></p> <ul style="list-style-type: none"> <li>◆ A blank setting means that no access rights are granted. The port will not show up on the user's LIST on the main screen.</li> <li>◆ The administrator always has full access to all ports.</li> </ul>

*(Continues on next page.)*

(Continued from previous page.)

Setting	Function
SET LOGOUT TIMEOUT	<p>If there is no input from the console for the amount of time set with this function, the user is automatically logged out. A login is necessary before the console can be used again.</p> <p>This enables other users to gain access to the computers when the original user is no longer accessing them, but has forgotten to log out. To set the timeout value, key in a number from 1–180 minutes, then press <b>[Enter]</b>. The default setting of 0 disables this function.</p> <p><b>Note:</b> This feature does not function if Set Login Mode is disabled. See <i>SET LOGIN MODE</i>, page 44.</p>
EDIT PORT NAMES	<p>To help remember which computer is attached to a particular port, every port can be given a name. This function allows the administrator to create, modify, or delete port names.</p> <p>To edit a port name:</p> <ol style="list-style-type: none"> <li>1. Click the port, or use the navigation keys to move the highlight bar to it, then press <b>[Enter]</b>.</li> <li>2. Key in the new port name, or modify/delete the old one. The maximum number of characters allowed for the port name is 12. Legal characters include: <ul style="list-style-type: none"> <li>◆ All alpha characters: <b>A–Z</b></li> <li>◆ All numeric characters: <b>0–9</b></li> <li>◆ <b>* ( ) + : - , ? . /</b></li> </ul> <p>Case does not matter; the OSD displays the port name in all capitals no matter how they were keyed in.</p> </li> <li>3. When you have finished editing, press <b>[Enter]</b> to have the change take effect. To abort the change, press <b>[Esc]</b>.</li> </ol>
RESTORE DEFAULT VALUES	<p>This function is used to undo all changes and return the setup to the original factory default settings (See <i>Factory Default Hotkeys and Settings</i>, page 77) except for the port name list, username and password information, which are saved.</p>
CLEAR THE NAME LIST	<p>This function clears the port name list.</p>
ACTIVATE BEEPER	<p>Choices are <b>Y</b> (on), or <b>N</b> (off). When activated, the beeper sounds whenever a port is changed; when activating the Auto Scan function (see <i>F7 SCAN</i>, page 46); or an invalid entry is made on an OSD menu. The default is <b>Y</b>.</p>

(Continues on next page.)

(Continued from previous page.)

Setting	Function
SET QUICK VIEW PORTS	<p>This function lets the administrator select which ports to include as quick view ports.</p> <ul style="list-style-type: none"> <li>◆ To select/deselect a port as a quick view port, double-click the port, or use the navigation keys to move the highlight bar to it, then press <b>[Spacebar]</b>.</li> <li>◆ When a port has been selected as a quick view port, an icon displays in the QV column of the LIST on the main screen. When a port is deselected, the icon disappears.</li> <li>◆ If one of the quick view options is chosen for the LIST view (see <i>F2 LIST</i>, page 38), only a port that has been selected here will display on the list.</li> <li>◆ If one of the quick view options is chosen for auto-scanning (See <i>SCAN-SKIP MODE</i>, page 40), only a port that has been selected here will be auto-scanned.</li> </ul> <p>The default has no ports selected for quick view.</p>
SET OPERATING SYSTEM	<p>This function allows the administrator to define the operating system for the computer connected to each KVM port. The default is WIN (PC compatible).</p> <p><b>To set the port operating system:</b></p> <ol style="list-style-type: none"> <li>1. From the list, select the port for which you wish to set the computer's operating system.</li> <li>2. Set the operating system by pressing <b>[Spacebar]</b> to cycle through WIN, MAC, SUN, or OTHER .</li> <li>3. Press <b>[Esc]</b> to exit. The operating system you selected is assigned to the KVM port.</li> </ol>
FIRMWARE UPGRADE	<p>In order to upgrade the CS1798 / CS17916 firmware (see page 61), you must first enable Firmware Upgrade mode with this setting.</p> <p>When you bring up this menu, the current firmware version levels are displayed. Select <b>Y</b> to enable Firmware Upgrade mode, or <b>N</b> to leave this menu without enabling it.</p>
KEYBOARD LANGUAGE	<p>Sets the language for the computer keyboard attached to the KVM port. To select a keyboard language, double-click it, or use the navigation keys to move the highlight bar to it, then press <b>[Enter]</b>.</p> <p>Choices are: AUTO (default), ENGLISH (US), ENGLISH (UK), GERMAN (GER.), GERMAN (SWISS), FRENCH, HUNGARIAN, ITALIAN, JAPANESE, KOREAN, RUSSIAN, SPANISH, SWEDISH, TRADITIONAL CHINESE, and SIMPLIFIED CHINESE.</p>

(Continues on next page.)

(Continued from previous page.)

Setting	Function
MOUSE EMULATION	Enables / disable mouse emulation function. <b>Note:</b> Supported in the first level of an installation only. Enable mouse emulation to perform any independent switching of a port and for Auto Scan Mode or Skip Mode to work.
ACTIVATE multi-display	Enables multi-display mode for dual, triple or quad displaying in multiple-monitor installations where each computer is fitted with multiple video cards. See <i>Multi-display Installation</i> , page 26, for full details. <b>Note:</b> multi-display mode must be enabled on the OSD before the cables are connected.
OSD CONFIG BACKUP / RESTORE	Enters OSD Configuration Backup / Restore mode. The Firmware Management Utility lets you backup the current OSD configuration of the CS1798 / CS17916, and restore it when necessary. Storing the OSD configuration settings is useful when deploying more than one installation that uses the same settings. See <i>OSD Configuration Backup/Restore</i> , page 67, for full details.
SET LOGIN MODE	This function allows the administrator to request users to login or not. When the login dialog box is disabled, the system disables the login/logout function. If the system is re-started, the login/logout function remains disabled.

## **F5: SKP**

Clicking the **F5** field or pressing [**F5**] invokes Skip (SKP) mode. This function enables you to easily skip backward or forward – switching the console focus from the currently active computer port to the previous or next accessible one. Enable mouse emulation for Skip mode to work (see page 42).

- ◆ The selection of computers available for skip mode switching is made with the *Scan-Skip* mode setting under the **F3: SET** function (see page 39).
- ◆ When you are in skip mode:
  - press [ ← ] to skip to the previous accessible port on the list
  - press [ → ] to skip to the next accessible port on the list
  - press [ ↑ ] to skip to the next accessible port. If the next accessible port has cascaded a switch, then it skips to the first accessible port of that switch
  - press [ ↓ ] to skip to the previous accessible port. If the previous accessible port has cascaded a switch, then it skips to the last accessible port of that switch

---

**Note:** When you skip, you only skip to the previous or next accessible computer that is in the *Scan-Skip* mode selection (see page 40).

---

- ◆ If a port has been selected for *Scan-Skip* mode, when the focus switches to that port a left/right triangle symbol appears before its port ID display. When the port ID with the triangle symbol displays, the background screen is blank.
- ◆ While skip mode is in effect, the console will not function normally. You must exit skip mode in order to regain control of the console.
- ◆ When the selected port displays, skip mode is automatically disabled.
- ◆ To exit skip mode, press [**Spacebar**] or [**Esc**].

## **F6: BRC**

F6 is an administrator only function. Clicking the **F6** field, or pressing [**F6**], invokes *Broadcast* (BRC) mode. When this function is in effect, commands sent from the console are broadcast to all available computers on the installation.

This function is particularly useful for operations that need to be performed on multiple computers, such as performing a system wide shutdown, installing or upgrading software, etc.

- ◆ While BRC mode is in effect, a speaker symbol appears before the port ID display of the port that currently has the console focus. When the port ID with the speaker symbol displays, the background screen is blank.
- ◆ While BRC mode is in effect, the mouse will not function normally. You must exit BRC mode in order to regain control of the mouse.
- ◆ To exit BRC mode, invoke the OSD (with the OSD hotkey), then click the **F6** field, or press **[F6]**, to turn BRC mode off.
- ◆ When BRC mode is in effect, the Scroll Lock LED flashes. It stops flashing and reverts to normal status when you exit BRC.

## **F7: SCAN**

Clicking the **F7** field or pressing **[F7]** invokes *Auto Scan* mode. This function allows you to automatically switch among the available computers at regular intervals so that you can monitor their activity without having to take the trouble of switching yourself. Enable mouse emulation for Auto Scan to work (see page 42).

- ◆ The selection of computers to be included for auto-scanning is made with the *Scan-Skip* mode setting under the **F3: SET** function (see page 40).
- ◆ The amount of time that each port displays for is set with the *Scan Duration* setting under the **F3: SET** function (see page 39). When you want to stop at a particular location, press the **[Spacebar]** to stop scanning.
- ◆ If the scanning stops on an empty port, or one where the computer is attached but is powered Off, the monitor screen will be blank, and the mouse and keyboard will have no effect. After the *Scan Duration* time is up, the scan function will move on to the next port.
- ◆ As each computer is accessed, an **S** appears in front of the port ID display to indicate that it is being accessed under *Auto Scan* mode. When the port ID with the symbol displays, the background screen is blank.
- ◆ While *Auto Scan* mode is in effect, the console will not function normally. You must exit *Auto Scan* mode in order to regain control of the console.
- ◆ While you are in *Auto Scan* mode, you can pause the scanning in order to keep the focus on a particular computer either by pressing **P**, or with a left-click of the mouse. See *Invoking Auto Scan*, page 51, for details.
- ◆ To exit *Auto Scan* mode, press the **[Spacebar]** or **[Esc]**.

## **F8: LOUT**

Clicking the **F8** field, or pressing **[F8]** logs you out of OSD control of the computers, and blanks the console screen. This is different from simply pressing **[Esc]** when you are at the main screen to deactivate the OSD. With this function you must log in all over again to regain access to the OSD, whereas with **[Esc]**, all you have to do to reenter the OSD is tap the OSD hotkey.

- 
- Note:**
1. When you reenter the OSD after logging out, the screen stays blank except for the OSD main screen. You must input your username and password before you can continue.
  2. If you reenter the OSD after logging out, and immediately use **[Esc]** to deactivate the OSD without having selected a port from the OSD menu, a null port message displays on the screen. The OSD hotkey will bring up the main OSD screen.
-

This Page Intentionally Left Blank

# Chapter 5

## Hotkey Operation

### Hotkey Port Control

---

Hotkey port control allows you to provide KVM focus to a particular computer directly from the keyboard. The CS1798 / CS17916 provides the following hotkey port control features:

- ◆ Selecting the Active Port
- ◆ Auto Scan Mode Switching\*
- ◆ Skip Mode Switching\*
- ◆ Computer Keyboard / Mouse Reset
- ◆ Enable / Disable Mouse Emulation\*

The following settings can also be controlled in *HSM* mode:

- ◆ Setting the Beeper
- ◆ Setting the Quick Hotkey
- ◆ Setting the OSD Hotkey
- ◆ Setting the Port Operating System
- ◆ Restoring the OSD Default Values

---

**Note:** Enable mouse emulation to perform any independent switching of a port and for Auto Scan Mode or Skip Mode to work (see page 56).

---

### Hotkey Setting Mode

---

Hotkey Setting Mode is used to set up your CS1798 / CS17916 switch configuration. All operations begin with invoking Hotkey Setting Mode (HSM).

#### Invoking HSM

To invoke HSM do the following:

1. Press and hold down [**Num Lock**].
2. Press and release [-].
3. Release [**Num Lock**].

**or**

1. Hold down the **[Ctrl]** key;
2. Press and release the **[F12]** key;
3. Release the **[Ctrl]** key:

[Ctrl] + [F12]

When *HSM* is active:

- ♦ A command line appears on the monitor screen. The command line prompt is the word *Hotkey*: in white text on a blue background, and displays the subsequent hotkey information that you key in.
- ♦ Ordinary keyboard and mouse functions are suspended – only hotkey compliant keystrokes (described in the sections that follow), can be input.

Pressing **[Esc]** exits *HSM*.

## Select the Active Port

---

Each KVM port is assigned a port ID (see *Port ID Numbering*, page 32). You can directly access any computer on the installation with a hotkey combination that specifies the port ID of the KVM port that a computer is connected to. To access a computer using hotkeys:

1. Invoke HSM with the **[Num Lock] + [-]** or **[Ctrl] + [F12]** combination.
2. Key in the port ID.  
The port ID numbers display on the command line as you key them in. If you make a mistake, use **[Backspace]** to erase the wrong number.
3. Press **[Enter]**.

After you press **[Enter]**, the KVM focus switches to the designated computer and you automatically exit HSM.

---

**Note:** In HSM, KVM focus will not switch to a port if an invalid switch or port number is entered. The hotkey command line will continue to display on the screen until you enter a valid switch and port number combination, or exit HSM.

---

## Auto Scan Mode

---

*Auto Scan* automatically switches, at regular intervals, among all the KVM ports that have been set as accessible under *Scan-Skip Mode*, so that their activity can be monitored automatically. See *Scan-Skip Mode* on page 40 for more information.

### Invoking Auto Scan:

To start *Auto Scan*, key in the following Hotkey combination:

1. Enable mouse emulation (see page 56).
2. Invoke *HSM* with the **[Num Lock] + [-]** or **[Ctrl] + [F12]** combination.
3. Press **[A]**. After you press **A**, then **[Enter]**, you automatically exit *HSM*, and enter *Auto Scan* mode.
  - ♦ While you are in *Auto Scan* mode, you can pause the scanning in order to keep the focus on a particular computer either by pressing **P** or with a left click of the mouse. During the time that auto-scanning is paused, the command line displays: **Auto Scan: Paused**.

*Pausing* when you want to keep the focus on a particular computer is more convenient than exiting *Auto Scan* mode because when you resume scanning, you start from where you left off. If, on the other hand, you exited and restarted, scanning would start over from the very first computer on the installation.

To resume Auto Scanning, press any key or left-click. Scanning continues from where it left off.

- ♦ While *Auto Scan* mode is in effect, ordinary keyboard and mouse functions are suspended – only *Auto Scan* mode compliant keystrokes and mouse clicks can be input. You must exit *Auto Scan* mode in order to regain normal control of the console.
4. To exit *Auto Scan* mode press **[Esc]** or **[Spacebar]**. Auto-scanning stops when you exit *Auto Scan* mode.

---

**Note:** Enable mouse emulation to perform any independent switching of a port and for Auto Scan Mode or Skip Mode to work (see page 56).

---

## Skip Mode

---

This feature allows you to switch between computers in order to monitor them manually. You can dwell on a particular port for as long as you like – as opposed to auto-scanning, which automatically switches after a fixed interval. To invoke *Skip* mode, key in the following hotkey combination:

1. Enable mouse emulation (see page 56).
2. Invoke *HSM* with the **[Num Lock] + [-]** or **[Ctrl] + [F12]** combination.
3. Key in **[Arrow]**
  - ◆ Where [Arrow] refers to one of the arrow keys. After you press an arrow, you automatically exit *HSM* and enter *Skip* mode where you can switch ports as follows:

←	Skips to the previous accessible port. (See <i>Scan/Skip Mode</i> , page 40, for information regarding accessible ports.)
→	Skips to the next accessible port.
↑	Skips to the previous accessible port. If the previous accessible port has cascaded a switch, then it skips to the last accessible port of that switch.
↓	Skips to the next accessible port. If the next accessible port has cascaded a switch, then it skips to the first accessible port of that switch.

- ◆ Once you are in *Skip* mode, you can keep on skipping by pressing the arrow keys. You don't have to use the **[Num Lock] + [-]** combination again.
  - ◆ While *Skip* mode is in effect, ordinary keyboard and mouse functions are suspended – only *Skip* mode compliant keystrokes can be input. You must exit *Skip* mode in order to regain normal control of the console.
4. To exit *Skip* mode, press **[Esc]** or **[Spacebar]**.

---

**Note:** Enable mouse emulation to perform any independent switching of a port and for Auto Scan Mode or Skip Mode to work (see page 56).

---

## Keyboard / Mouse Reset

---

If the keyboard or mouse cease to function on the computer connected to the currently selected port, you can perform a keyboard / mouse reset on the computer. This function is essentially the same as unplugging and replugging the keyboard and mouse on the target computer. To perform a computer keyboard / mouse reset, key in the following hotkey combination:

1. Invoke *HSM* with the **[Num Lock] + [-]** or **[Ctrl] + [F12]** combination.
2. Press **[F5]**.

After you press **[F5]** you automatically exit *HSM* and regain keyboard and mouse control on the computer connected to the KVM port. If you fail to regain keyboard / mouse control on the computer after pressing **[F5]**, perform a console keyboard and mouse reset. For more information see *port LEDs*, page 7.

## Hotkey Beeper Control

---

The beeper (see *Activate Beeper*, page 42) can be hotkey toggled on and off. To toggle the beeper, key in the following hotkey combination:

1. Invoke *HSM* with the **[Num Lock] + [-]** or **[Ctrl] + [F12]** combination.
2. Press **[B]**.

After you press **[B]**, the beeper toggles on or off. The command line displays *Beeper On* or *Beeper Off* for one second; then the message disappears and you automatically exit *HSM*.

## Quick Hotkey Control

---

The *Quick Hotkey* (see *HOTKEY*, page 40) can be toggled between **[Num Lock] + [-]**, and **[Ctrl] + [F12]**. To toggle the *Quick Hotkey*:

1. Invoke *HSM* with the **[Num Lock] + [-]** or **[Ctrl] + [F12]** combination.
2. Press **[H]**.

After you press **[H]**, the command line displays *HOTKEY HAS BEEN CHANGED* for one second; then the message disappears and you automatically exit *HSM*.

## OSD Hotkey Control

---

The *OSD Hotkey* (see *OSD HOTKEY*, page 39) can be toggled between [Scroll Lock], [Scroll Lock] and [Ctrl], [Ctrl]. To toggle the *OSD Hotkey*, key in the following hotkey combination:

1. Invoke *HSM* with the [Num Lock] + [-] or [Ctrl] + [F12] combination.
2. Press [T].

After you press [T], the command line displays *HOTKEY HAS BEEN CHANGED* for one second; then the message disappears and you automatically exit *HSM*.

## Port OS Control

---

A port's operating system can be changed to match that of the computer attached to the port. To change a port's operating system, key in the following hotkey combination:

1. Invoke *HSM* with the [Num Lock] + [-] or [Ctrl] + [F12] combination.
2. Key in [Function], where [Function] refers to one of the function keys in the following table:

Key	Description
F1	Sets the Port OS to Windows
F2	Sets the Port OS to Mac
F3	Sets the Port OS to Sun

After pressing a function key you automatically exit *HSM*.

## Set USB Speed

---

Users could use the hotkey to set USB speed of the selected KVM port as low/full speed to compliant with the connected computers.

1. Invoke hotkey mode with the [Num Lock] + [-] or [Ctrl] + [F12] combination (see page 40).
2. Press [F11][L]/[F11][F].
3. Press [Enter].  
[L] Indicates the selected KVM port set as USB low speed.

**[F]** Indicates the selected KVM port set as USB full speed.

If users need to set all KVM ports of the selected KVM station, the hotkey commands should be **[F11][L][A]**, **[Enter]/[F11][F][A]**, **[Enter]**.

## **Restore Default Values**

---

This administrator only hotkey restores the CS1798 / CS17916 default values. See [?\\$paratext>?](#) on page 77. To restore the default values, key in the following hotkey combination:

1. Invoke *HSM* with the **[Num Lock] + [-]** or **[Ctrl] + [F12]** combination.
2. Press **[R]**.
3. Press **[Enter]**.

After you press [Enter], the command line displays *RESET TO DEFAULT SETTING* for three seconds; then the message disappears and you automatically exit *HSM*.

## **USB Reset**

If the USB loses focus and needs to be reset, do the following:

1. Invoke *HSM* (see page 49).
2. Press and release **[F5]**.

## **Hotkey Beeper Control**

The beep can be enabled or disabled. The default setting is enabled. To disable the Buzzer, do the following:

1. Invoke *HSM* (see page 49).
2. Press and release **[B]**.

This procedure is a toggle. Repeat to enable.

## **Video DynaSync**

Video DynaSync is ATEN's exclusive technology that eliminates boot-up display problems and optimizes resolution when switching between ports. To invoke Video DynaSync, do the following:

1. Invoke *HSM* (see page 49).
2. Press [**D**].

---

**Note:** If the monitor is disconnected and reconnected, the CS1798 / CS17916 re-executes Video DynaSync.

---

### **Mouse Emulation Control**

The default setting is enabled. To disable, do the following:

1. Invoke *HSM* (see page 49).
2. Press [**M**].

This procedure is a toggle. Repeat to enable.

---

**Note:** Enable mouse emulation to perform any independent switching of a port and for Auto Scan Mode or Skip Mode to work.

---

## HSM Summary Table

After invoking HSM (see page 49), key in one of the following keys to perform the corresponding function:

Key	Function
[PN] [Enter]	Switches KVM, Audio, and USB focus directly to the computer that corresponds to that port ID. (PN = port number)
[PN] [K] [Enter]	Switches KVM focus only directly to the computer that corresponds to that port ID. (PN = port number)
[PN] [U] [Enter]	Switches USB focus only directly to the computer that corresponds to that port ID. (PN = port number) <b>Note:</b> This hotkey functions on the first level of an installation only.
[A] [Enter]	Starts Auto Scan. The KVM focus cycles from port to port at the default 5-second intervals
[A] [n] [Enter]	Starts Auto Scan at <i>n</i> -second intervals ( <i>n</i> = 1–255 seconds)
[H]	Toggles between the default ([Num Lock] [-]) and alternate ([Ctrl] [F12]) HSM invocation keys.
[T]	Toggles between the default ([Scroll Lock] [Scroll Lock]) and alternate ([Ctrl] [Ctrl]) OSD Hotkey.
[F1]	Sets the port OS to Windows.
[F2]	Sets the port OS to Mac.
[F3]	Sets the port OS to Sun.
[F5]	Performs a keyboard / mouse reset on the target computer.
[B]	Enables/Disables the beeper.
[R] [Enter]	Resets the hotkey settings to their default status. See <i>Factory Default Hotkeys and Settings</i> , page 77.
[D]	Invokes Video DynaSync, ATEN's exclusive technology that eliminates boot-up display problems and optimizes resolution when switching between ports.
[M]	Enables/Disables mouse emulation.
[ ← ]	Skips to the previous computer on the list, in skip mode.

Key	Function
[ → ]	Skips to the next computer on the list, in skip mode.
[ ↑ ]	Skips to the next accessible port. If the next accessible port has cascaded a switch, then it skips to the first accessible port of that switch, in skip mode.
[ ↓ ]	Skips to the previous accessible port. If the previous accessible port has cascaded a switch, then it skips to the last accessible port of that switch, in skip mode.
[ESC] or [Spacebar]	Exits hotkey setting mode.

---

**Note:** Enable mouse emulation to perform any independent switching of a port and for Auto Scan Mode or Skip Mode to work (see page 56).

---









# Chapter 6

## Keyboard Emulation

### Mac Keyboard

---

The PC compatible (101/104 key) keyboard can emulate the functions of the Mac keyboard. The emulation mappings are listed in the table below.

PC Keyboard	Mac Keyboard
[Shift]	Shift
[Ctrl]	Ctrl
	
[Ctrl] [1]	
[Ctrl] [2]	
[Ctrl] [3]	
[Ctrl] [4]	
[Alt]	Alt
[Print Screen]	F13
[Scroll Lock]	F14
	=
[Enter]	Return
[Backspace]	Delete
[Insert]	Help
[Ctrl] 	F15







---

**Note:** When using key combinations, press and release the first key (Ctrl), then press and release the activation key.

---

## Sun Keyboard

The PC compatible (101/104 key) keyboard can emulate the functions of the Sun keyboard when the Control key [Ctrl] is used in conjunction with other keys. The corresponding functions are shown in the table below.

PC Keyboard	Sun Keyboard
[Ctrl] [T]	Stop
[Ctrl] [F2]	Again
[Ctrl] [F3]	Props
[Ctrl] [F4]	Undo
[Ctrl] [F5]	Front
[Ctrl] [F6]	Copy
[Ctrl] [F7]	Open
[Ctrl] [F8]	Paste
[Ctrl] [F9]	Find
[Ctrl] [F10]	Cut
[Ctrl] [1]	
[Ctrl] [2]	
[Ctrl] [3]	
[Ctrl] [4]	
[Ctrl] [H]	Help
	Compose
	

**Note:** When using key combinations, press and release the first key (Ctrl), then press and release the activation key.

# Chapter 7

## The Firmware Management Utility

### Introduction

---

The purpose of the Windows-based Firmware Management Utility is to provide an automated process for upgrading all CS1798 / CS17916 switches in an installation. The program comes as part of a Firmware Upgrade Package that is specific for each device.

As new firmware versions become available, new firmware upgrade packages are posted on our website. Check the website regularly to find the latest information and packages.

### Downloading the Firmware Upgrade Package

To download the firmware upgrade package:

1. From a computer that is not part of your KVM installation go to our website and choose the model name that relates to your device. A list of available firmware upgrade packages appears.
2. Choose the firmware upgrade package that you wish to install (usually the most recent) and download it to your computer.

## Preparation

---

To prepare for the firmware upgrade, do the following:

1. Use the *firmware upgrade cable* provided with this unit to connect a COM port on your computer to the *firmware upgrade port* of your switch.

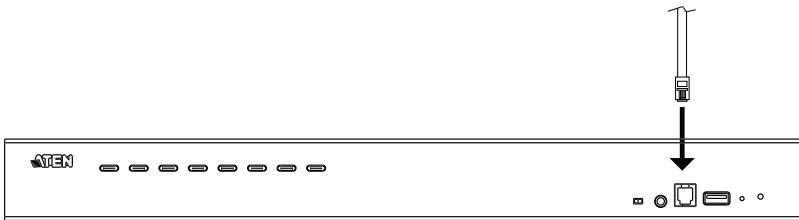
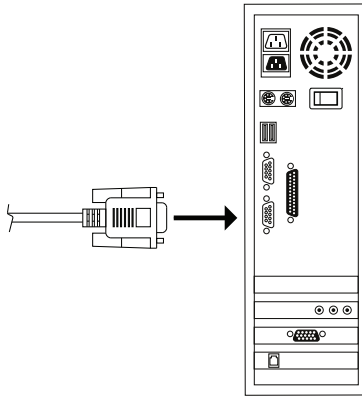

2. Shut down all the computers on the KVM installation.
3. From your KVM switch console, login to the OSD as the administrator (see p. 35) and select the **F4 ADM** function.
4. Scroll down to FIRMWARE UPGRADE. Press **[Enter]**, then press **[Y]** to invoke *Firmware Upgrade* mode (see p. 43.)

---

## Starting the Upgrade

---

To upgrade the firmware:

1. Run the downloaded firmware upgrade package file either by double-clicking the file icon, or by opening a command line and entering the full path to it.

The *Firmware Upgrade Utility* welcome screen appears:

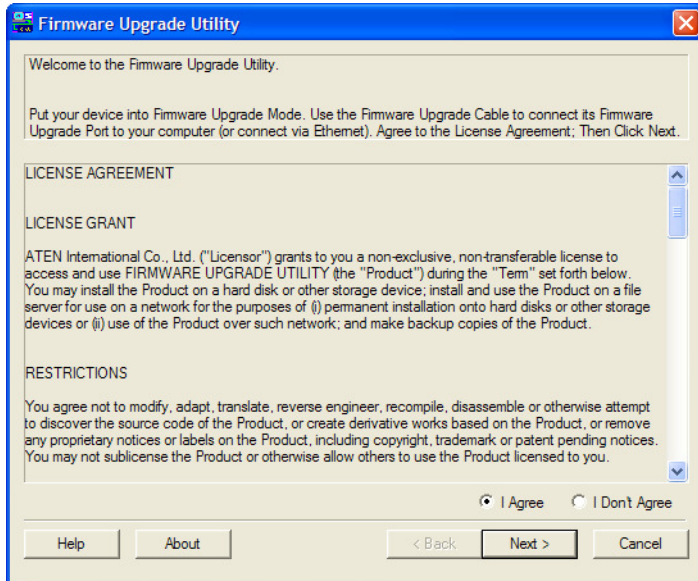

---

**Note:** The screens shown in this section are for reference only. The wording and layout of the actual screens put up by the *Firmware Upgrade Utility* may vary slightly from these examples.

---

2. Read and *Agree* to the License Agreement (enable the I Agree radio button).
3. Click **Next** to continue. The *Firmware Upgrade Utility* main screen appears. The devices capable of being upgraded are listed in the *Device List* panel:

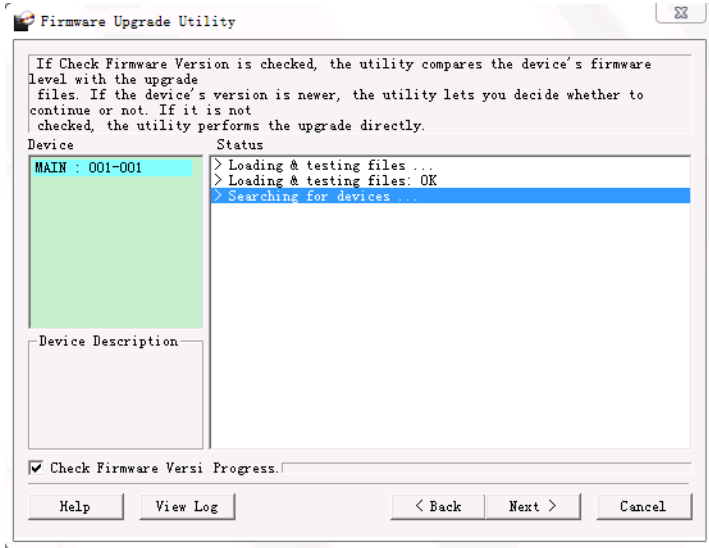

4. Click **Next** to perform the upgrade.

If you enabled *Check Firmware Version*, the Utility compares the device's firmware level with that of the upgrade files. If it finds that the device's version is higher than the upgrade version, it brings up a dialog box informing you of the situation and gives you the option to continue or cancel.

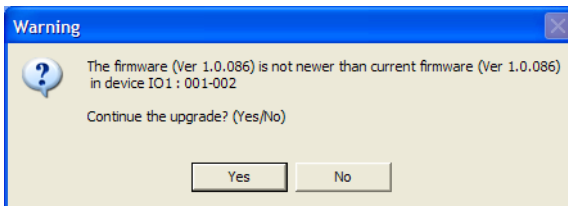

If you didn't enable *Check Firmware Version*, the Utility installs the upgrade files without checking whether they are a higher level, or not.

As the upgrade proceeds, status messages appear in the *Status Messages* panel, and the progress toward completion is shown on the *Progress* bar.

## Upgrade Succeeded

After the upgrade has completed, a screen appears to inform you that the procedure was successful.

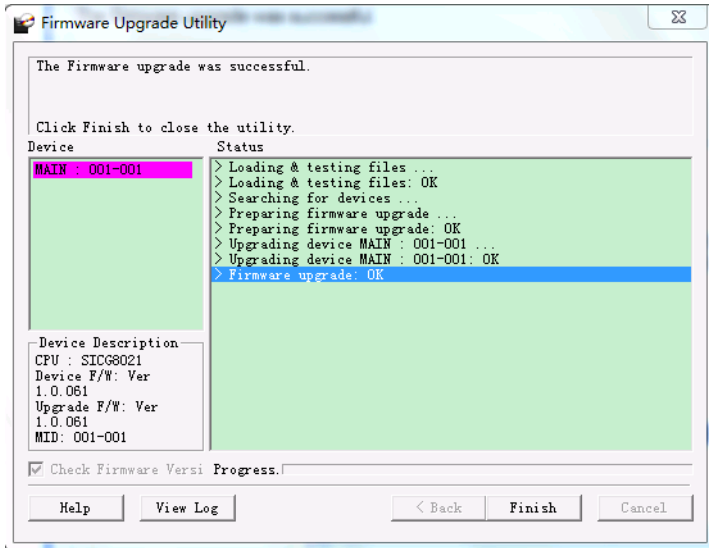

Click **Finish** to close the *Firmware Upgrade Utility*.

## Upgrade Failed

If the *Upgrade Succeeded* screen doesn't appear, it means that the upgrade failed to complete successfully. See the next section, *Firmware Upgrade Recovery*, for how to proceed.

## Firmware Upgrade Recovery

---

There are three conditions that call for firmware upgrade recovery:

- ◆ When a firmware upgrade is manually aborted.
- ◆ When the mainboard firmware upgrade fails.
- ◆ When the I/O firmware upgrade fails.

To perform a firmware upgrade recovery, do the following:

1. Power off the switch.
2. Connect the *firmware upgrade cable* to its *firmware upgrade port*.
3. Slide the *firmware upgrade recovery switch* to the **Recover** position.
4. Power the switch back on and repeat the upgrade procedure.
5. After the switch has been successfully upgraded, power it off, and slide the *firmware upgrade recovery switch* back to the **Normal** position.
6. If the switch is one of the cascaded switches, plug it back into the installation.
7. Power the switch back on.

## OSD Configuration Backup/Restore

The Firmware Management Utility lets you backup the current OSD configuration of the CS1798 / CS17916, and restore it when necessary. Storing the OSD configuration settings is useful when deploying more than one installation that uses the same settings.

### Backup

Follow these steps to store a backup file to a local computer:

1. Make sure your computer is connected to the CS1798 / CS17916. See *Preparation*, page 62, and follow steps 1–3.
2. When you have selected the **F4 ADM** function, scroll down to OSD CONF BACKUP / RESTORE. Press **[Enter]**, then press **[Y]** to invoke *OSD Config Backup / Restore* mode.
3. Run the Firmware Management Utility. In the dialog box, choose *OSD Configuration Backup/Restore*, then click Next.
4. In the window that appears, click *Connect Device*.

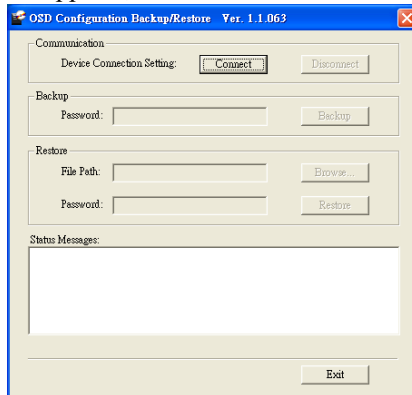

5. In the *Password* field, key in a password for the file.

---

**Note:** Setting a password is optional. If you do not set one, the file can be restored without specifying a password.

---

6. Click **Backup**.
7. When the browser asks what you want to do with the file, select *Save to disk*, then save it in a convenient location.

## **Restore**

Follow these steps to restore a backup file from a local computer:

1. Do steps 1 to 3 of the previous section. See *Backup*, page 67.
2. Click **Restore** to recover an OSD configuration stored in the local computer. If you have previously set a password for this feature, enter the password in the provided field before clicking **Restore**. A confirmation window appears; click **Yes** to proceed.
3. Browse for the OSD configuration file you want to use and click **Restore**. Make sure the backup file is in the local computer.
4. A confirmation window appears when the restore process is done and successful. Click **OK** to close it.

## Safety Instructions

---

### General

- ◆ This product is for indoor use only.
- ◆ Read all of these instructions. Save them for future reference.
- ◆ Follow all warnings and instructions marked on the device.
- ◆ Do not place the device on any unstable surface (cart, stand, table, etc.). If the device falls, serious damage will result.
- ◆ Do not use the device near water.
- ◆ Do not place the device near, or over, radiators or heat registers.
- ◆ The device cabinet is provided with slots and openings to allow for adequate ventilation. To ensure reliable operation, and to protect against overheating, these openings must never be blocked or covered.
- ◆ The device should never be placed on a soft surface (bed, sofa, rug, etc.) as this will block its ventilation openings. Likewise, the device should not be placed in a built in enclosure unless adequate ventilation has been provided.
- ◆ Never spill liquid of any kind on the device.
- ◆ Unplug the device from the wall outlet before cleaning. Do not use liquid or aerosol cleaners. Use a damp cloth for cleaning.
- ◆ The device should be operated from the type of power source indicated on the marking label. If you are not sure of the type of power available, consult your dealer or local power company.
- ◆ To prevent damage to your installation it is important that all devices are properly grounded.
- ◆ Do not allow anything to rest on the power cord or cables. Route the power cord and cables so that they cannot be stepped on or tripped over.
- ◆ Position system cables and power cables carefully; Be sure that nothing rests on any cables.
- ◆ Never push objects of any kind into or through cabinet slots. They may touch dangerous voltage points or short out parts resulting in a risk of fire or electrical shock.
- ◆ Do not attempt to service the device yourself. Refer all servicing to qualified service personnel.

- ◆ If the following conditions occur, unplug the device from the wall outlet and bring it to qualified service personnel for repair.
  - ◆ The power cord or plug has become damaged or frayed.
  - ◆ Liquid has been spilled into the device.
  - ◆ The device has been exposed to rain or water.
  - ◆ The device has been dropped, or the cabinet has been damaged.
  - ◆ The device exhibits a distinct change in performance, indicating a need for service.
  - ◆ The device does not operate normally when the operating instructions are followed.
- ◆ Only adjust those controls that are covered in the operating instructions. Improper adjustment of other controls may result in damage that will require extensive work by a qualified technician to repair.
- ◆ Do not connect the RJ-11 connector marked “UPGRADE” to a public telecommunication network.

---

## **Rack Mounting**

- ◆ Before working on the rack, make sure that the stabilizers are secured to the rack, extended to the floor, and that the full weight of the rack rests on the floor. Install front and side stabilizers on a single rack or front stabilizers for joined multiple racks before working on the rack.
- ◆ Always load the rack from the bottom up, and load the heaviest item in the rack first.
- ◆ Make sure that the rack is level and stable before extending a device from the rack.
- ◆ Use caution when pressing the device rail release latches and sliding a device into or out of a rack; the slide rails can pinch your fingers.
- ◆ After a device is inserted into the rack, carefully extend the rail into a locking position, and then slide the device into the rack.
- ◆ Do not overload the AC supply branch circuit that provides power to the rack. The total rack load should not exceed 80 percent of the branch circuit rating.
- ◆ Make sure that all equipment used on the rack – including power strips and other electrical connectors – is properly grounded.
- ◆ Ensure that proper airflow is provided to devices in the rack.
- ◆ Ensure that the operating ambient temperature of the rack environment does not exceed the maximum ambient temperature specified for the equipment by the manufacturer.
- ◆ Do not step on or stand on any device when servicing other devices in a rack.
- ◆ **Caution:** Slide/rail (LCD KVM) mounted equipment is not to be used as a shelf or a work space.



## Technical Support

---

### International

- ◆ For online technical support – including troubleshooting, documentation, and software updates: **<http://support.aten.com>**
- ◆ For telephone support, see *Telephone Support*, page v:

### North America

Email Support		<a href="mailto:support@aten-usa.com">support@aten-usa.com</a>
Online Technical Support	Troubleshooting Documentation Software Updates	<a href="http://www.aten-usa.com/support">http://www.aten-usa.com/support</a>
Telephone Support		1-888-999-ATEN ext 4988

When you contact us, please have the following information ready beforehand:

- ◆ Product model number, serial number, and date of purchase.
- ◆ Your computer configuration, including operating system, revision level, expansion cards, and software.
- ◆ Any error messages displayed at the time the error occurred.
- ◆ The sequence of operations that led up to the error.
- ◆ Any other information you feel may be of help.

## CS1798 / CS17916 Connection Tables

The following tables indicate the relationship between the number of Master View units and the number of computers that they control:

### CS1798

MVs	Computers	MVs	Computers	MVs	Computers	MVs	Computers
1	1 - 8	20	134 - 141	39	267 - 274	58	400 - 407
2	8 -15	21	141 - 148	40	274 - 281	59	407 - 414
3	15 - 22	22	148 - 155	41	281 - 288	60	414 - 421
4	22 - 29	23	155 - 162	42	288 - 295	61	421 - 428
5	29 - 36	24	162 - 169	43	295 - 302	62	428 - 435
6	36 - 43	25	169 - 176	44	302 - 309	63	435 - 442
7	43 - 50	26	176 - 183	45	309 - 316	64	442 - 449
8	50 - 57	27	183 - 190	46	316 - 323	65	449 - 456
9	57 - 64	28	190 - 197	47	323 - 330	66	456 - 463
10	64 - 71	29	197 - 204	48	330 - 337	67	463 - 470
11	71 - 78	30	204 - 211	49	337 - 344	68	470 - 477
12	78 - 85	31	211 - 218	50	344 - 351	69	477 - 484
13	85 - 92	32	218 - 225	51	351 - 358	70	484 - 491
14	92 - 99	33	225 - 232	52	358 - 365	71	491 - 498
15	99 - 106	34	232 - 239	53	365 - 372	72	498 - 505
16	106 - 113	35	239 - 246	54	372 - 379	73	505 - 512
17	113 - 120	36	246 - 253	55	379 - 386		
18	120 - 127	37	253 - 260	56	386 - 393		
19	127 - 134	38	260 - 267	57	393 - 400		

### CS17916

MVs	Computers	MVs	Computers	MVs	Computers	MVs	Computers
1	1 - 16	5	63 - 79	9	127 - 143	13	191 - 207
2	16 -31	6	79 - 95	10	143 - 159	14	207 - 223
3	31 - 47	7	95 - 111	11	159 - 175	15	223 - 239
4	47 - 63	8	111 - 127	12	175 - 191	16	239 - 256

## Specifications

Function		CS1798	CS17916	
Computer Connections	Direct	8	16	
	Max.	512 (via Cascade)	256 (via Cascade)	
Port Selection		OSD, Hotkey, Pushbutton		
Connectors	Console Ports	KB	1 x USB Type-A Female (Black)	
		Video	1 x HDMI Female	
		Mouse	1 x USB Type-A Female (Black)	
		Speakers	2 x Mini Stereo Jack F (Green; 1 x front panel, 1 x rear panel)	
	KVM Ports	KB / Mouse	8 x USB Type-B Female (White)	16 x USB Type-B Female (White)
		Video	8 x HDMI Female (White)	16 x HDMI Female (White)
		Speakers	8 x Mini Stereo Jack Female (Green)	16 x Mini Stereo Jack Female (Green)
	F/W Upgrade		1 x RJ11 Female (Black)	
	Power		1 x DC Jack	
	USB 2.0 Hub		2 x USB Type-A Female (White) (1 x front panel, 1 x rear panel)	
Switches	Port Selection	8 x Pushbutton	16 x Pushbutton	
	Reset	1 x Semi-recessed Pushbutton		
	F/W Upgrade	1 x Slide Switch		
LEDs	USB Link	8 (Green)	16 (Green)	
	On Line / Selected	8 (Orange)	16 (Orange)	
	Power	1 (Dark Green)		
Emulation	Keyboard / Mouse	USB		
Video		1920 x 1080 @ 60 Hz / 1920 x 1200 @ 60Hz		
Scan Interval		1–255 Seconds (Default: 5 secs)		
Power Consumption		DC5V:5.8W:53BTU/h	DC5V:9.18W:69BTU/h	
		<p><b>Note:</b></p> <ul style="list-style-type: none"> <li>◆ The measurement in Watts indicates the typical power consumption of the device with no external loading.</li> <li>◆ The measurement in BTU/h indicates the power consumption of the device when it is fully loaded.</li> </ul>		
Environment	Operating Temp.	0–50°C		
	Storage Temp	-20–60°C		
	Humidity	0–80% RH, Non-condensing		

---

Function		CS1798	CS17916
Physical Properties	Housing	Metal	
	Weight	3.49 kg (7.69 lb)	3.86 kg (8.5 lb)
	Dimensions (L x W x H)	43.24 x 25.72 x 4.40 cm (17.02 x 10.13 x 1.73 in)	

---

## Administrator Login Failure

If you are unable to perform an Administrator login (because the username/ password information has become corrupted, or you have forgotten it, for example), you can clear the login information with the following procedure:

1. Power off the CS1798 / CS17916 and remove its housing.
2. Short the jumper labeled J29.

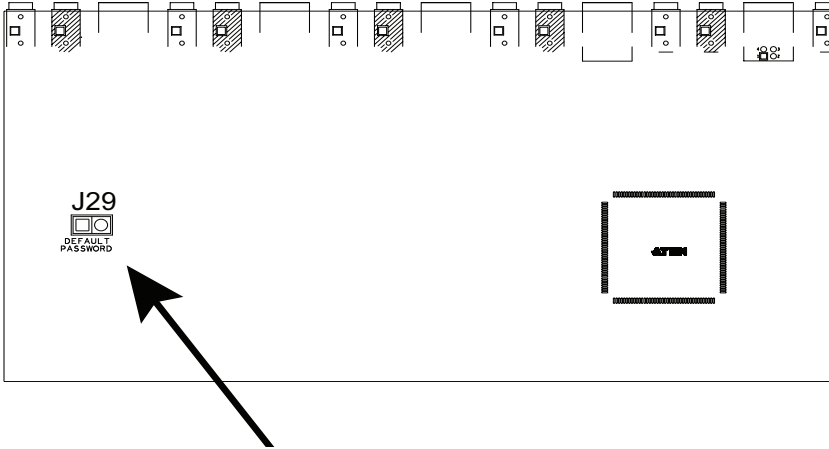

3. Power on the switch.
4. When the front panel LEDs flash, power off the switch.
5. Remove the jumper cap from J29.
6. Close the housing and start the CS1798 / CS17916 back up.

After you start back up, you can use the default login procedure (see *OSD Login*, page 35) to login.

---

## Factory Default Hotkeys and Settings

---

Setting	Hotkey	Default
OSD Hotkey (Default / Alternate)	[T]	[Scroll Lock] [Scroll Lock]
Invoking HSM	[H]	[Number Lock] [-]
Auto Scan Interval	[A] [Enter]	5 seconds
Mouse Emulation	[M]	Enabled
Port Switching Keys (On / Off)	[X] [Enter]	Enabled
Beeper	[B]	Enabled
Video DynaSync	[D]	Enabled

## **ATEN Warranty Policy**

---

The warranty policy may vary by product category and region of purchase. For details, please visit ATEN's official website, select your purchase counties/regions and then go to the Support Center, or contact your local ATEN sales representative for further assistance.

© Copyright 2025 ATEN® International Co., Ltd.  
Released: 2026-01-02

ATEN and the ATEN logo are registered trademarks of ATEN International Co., Ltd. All rights reserved. All other brand names and trademarks are the registered property of their respective owners.

**A**

- Activate Beeper 40
- ADM 39
- Auto Scanning 44
  - Invoking Auto Scan 49
  - Pausing Auto Scan 49
  - Scan Duration 37
  - Stopping 49

**B**

- Beeper
  - Activate 40
  - Control 51
  - Hotkey Control 51, 52
- BRC 43
- Broadcast Mode 43

**C**

- Clear the Name List 40
- Components 7
- Computer Connection Tables 71

**D**

- desktop mounting 14

**E**

- Edit Port Names 40

**F**

- F1: GOTO 36
- F2: LIST 36
- F3: SET 37
- F4: ADM 39
- F5: SKP 43
- F6: BRC 43
- F7: SCAN 44
- F8: LOUT 45
- Firmware upgrade

- OSD setting 41
- port 60
- recovery 64

**G**

- GOTO 36

**H**

- Hot Plugging 29
  - Console Ports 29
  - KVM ports 29
- Hotkey
  - Beeper Control 51, 52
  - Command Mode 38
  - OSD 37
  - Selecting the Active Port 48
- Hotkey Mode
  - exiting 48
- Hotkey Port Control 47

**I**

- Installation
  - two stage 21

**K**

- Keyboard Emulation
  - Mac 57
  - Sun 58

**L**

- LIST 36
- Logout 45
- Logout Timeout 40
- LOUT 45

**M**

- mounting
  - desktop 14
  - rack 14

## O

Online

Registration iv

OSD

Functions 35

Hotkey 33, 37

Logout 45

Main Screen 33, 34

Main Screen Headings 34

Navigation 35

Overview 33

Password 33

## P

Password 33

Pause 44

Port ID

Display Duration 37

Display Mode 37

Display Position 37

Numbering 30

Port Names 40

Port Selection 30

Manual 30

ports

quick view 41

set operating system 41

Powering Off and Restarting 31

## Q

quick view ports 41

## R

Rack Mounting

Safety information 69

rack mounting 14

front 15

rear 17

Requirements

Operating Systems 6

OS Support 6

Restore Default Values 40

RoHS ii

## S

Safety Instructions

General 67

Rack Mounting 69

SCAN 44

Scan Duration 37

SCAN/SKIP MODE 38

Screen Blanker 38

Selecting the Active Port 48

SET 37

Accessible Ports 39

Logout Timeout 40

Quick View Ports 41

SJ/T 11364-2006 iii

Skip Mode 43, 50

Specifications 72

stacking 14

## T

Technical Support 70

Telephone support iv

Timeout 40

Two Stage Installation 21

## U

User Notice iv

---