



KA8270 / KA8278

KA8280 / KA8288

**KVM over IP Console Station
User Manual**

Compliance Statements

FEDERAL COMMUNICATIONS COMMISSION INTERFERENCE STATEMENT

This equipment has been tested and found to comply with the limits for a Class A digital device, pursuant to Part 15 of the FCC Rules. These limits are designed to provide reasonable protection against harmful interference when the equipment is operated in a commercial environment. This equipment generates, uses, and can radiate radio frequency energy and, if not installed and used in accordance with the instruction manual, may cause harmful interference to radio communications. Operation of this equipment in a residential area is likely to cause harmful interference in which case the user will be required to correct the interference at his own expense.

The device complies with Part 15 of the FCC Rules. Operation is subject to the following two conditions: (1) this device may not cause harmful interference, and (2) this device must accept any interference received, including interference that may cause undesired operation.

FCC Caution

Any changes or modifications not expressly approved by the party responsible for compliance could void the user's authority to operate this equipment.

Warning

Operation of this equipment in a residential environment could cause radio interference.

Achtung

Der Gebrauch dieses Geräts in Wohnumgebung kann Funkstörungen verursachen.



KCC Statement:

유선 제품용 / A 급 기기 (업무용 방송 통신 기기)
이 기기는 업무용 (A 급) 전자파적합기기로서 판매자 또는 사용자는 이
점을 주의하시기 바라며, 가정 외의 지역에서 사용하는 것을 목적으로
합니다.

Industry Canada Statement

This Class A digital apparatus complies with Canadian ICES-003.

CAN ICES-003 (A) / NMB-003 (A)

HDMI Trademark Statement

The terms HDMI, HDMI High-Definition Multimedia Interface, and the HDMI Logo are trademarks or registered trademarks of HDMI Licensing Administrator, Inc.



RoHS

This product is RoHS compliant.

User Information

Online Registration

Be sure to register your product at our online support center:

International	http://eservice.aten.com
---------------	---

Telephone Support

For telephone support, call this number:

International	886-2-8692-6959
China	86-400-810-0-810
Japan	81-3-5615-5811
Korea	82-2-467-6789
North America	1-888-999-ATEN ext 4988 1-949-428-1111

User Notice

All information, documentation, and specifications contained in this manual are subject to change without prior notification by the manufacturer. The manufacturer makes no representations or warranties, either expressed or implied, with respect to the contents hereof and specifically disclaims any warranties as to merchantability or fitness for any particular purpose. Any of the manufacturer's software described in this manual is sold or licensed *as is*. Should the programs prove defective following their purchase, the buyer (and not the manufacturer, its distributor, or its dealer), assumes the entire cost of all necessary servicing, repair and any incidental or consequential damages resulting from any defect in the software.

The manufacturer of this system is not responsible for any radio and/or TV interference caused by unauthorized modifications to this device. It is the responsibility of the user to correct such interference.

The manufacturer is not responsible for any damage incurred in the operation of this system if the correct operational voltage setting was not selected prior to operation. **PLEASE VERIFY THAT THE VOLTAGE SETTING IS CORRECT BEFORE USE.**

Product Information

For information about all ATEN products and how they can help you connect without limits, visit ATEN on the Web or contact an ATEN Authorized Reseller. Visit ATEN on the Web for a list of locations and telephone numbers:

International	http://www.aten.com
North America	http://www.aten-usa.com

Package Contents

Check to make sure that all the components are in working order. If you encounter any problem, please contact your dealer.

1 KVM over IP Console Station (KA8270 / KA8278 / KA8280 / KA8288)

1 power adapter

1 power cord

1 mounting kit

1 foot pad set (4 pcs)

1 user instructions

Contents

Compliance Statements	ii
User Information	iv
Online Registration	iv
Telephone Support	iv
User Notice	iv
Product Information	v
Package Contents	vi
Contents	vii
About This Manual	xi
Conventions	xii
Chapter 1. Introduction	
Overview	1
Features	2
Requirements	3
Console	3
Components	4
Front View	4
Rear View	5
Chapter 2. Hardware Setup	
Overview	7
Before You Begin	7
Mounting	8
Rack Mount	8
Wall Mount	9
Single-Stage Installation	10
Hot Plugging	11
Powering Off and Restarting	12
Chapter 3. Operation	
Overview	13
Logging In	13
Upgrading KVM over IP Switch via Console Station	16
Dashboard	19
Page Components	19
Dashboard Operation	21
Monitor Unit Option	22
Primary / Secondary Display	22
GUI	23
Disconnect	23
Reconnect	23
Device / Panel Array View and Management	24
Device Options	24
Device View	25

Panel Array Options	25
Panel Array View	26
Manage Device / Panel Array View	28
Adding a Device / Panel Array View	28
Adding another Device View	30
Editing a Device View	31
Deleting a Device View	31
Boundless Switching with Cascade	32
Selecting a Display	33
Stopping the Cascade	33
Extended Desktop	34

Chapter 4. Device Management

Overview	37
Device List	38
Search	38
Remove Device	38
Adding Devices	38
Adding KVM over-IP Devices	41
Changing Connection Information	42

Chapter 5. System Configuration

Overview	43
User Management	44
Users and Groups	44
Add User	45
Copy User	48
Modify User	48
Delete User	48
Managing (Assigning) Users and Groups	49
Using User Configuration Page	49
Using Group Configuration Page	50
Device Assignment	52
Using Device Configuration Page	52
Assigning RDP / VNC / SSH / Telnet Device Access to Users	54
System Management	55
System Information	55
Network	55
IP Installer	56
IPv4 Settings	57
IPv6 Settings	58
Finishing Up	58
ANMS	58
RADIUS Settings	59
AD / LDAP Settings	60
Finishing Up	61
Security	62

Login Failures	62
Account Policy	63
Working Mode	64
Finishing Up	64
Cascade	65
Finishing Up	65
Maintenance	66
Upgrade Main Firmware	66
Firmware Upgrade Recovery	68
Backup / Restore	68
Backup	69
Restore	70
Push / Pull Configuration	71
Pull Configuration	72
Push Configuration	72
Terminal	73
System Operation	75
Reset Default Values	75
Reset on exit:	75
Switch Video Output	76
Quick User Configuration	77

Chapter 6. Toolbar Interface

Overview	79
Exit Remote Location	80
Video Settings	81
Macros	83
Hotkeys	83
User Macros	85
Import / Export Macros	88
Delete Macros	89
Search Macros	89
System Macros	89
Further Configuration	90
Virtual Media	91
Message Board	93
Mouse Sync Mode	95

Appendix

Safety Instructions	97
General	97
Rack Mounting	98
Technical Support	100
International	100
North America	100
Specifications	101
Troubleshooting	103

- General Operation 103
- Mouse Problems 104
- Virtual Media 105
- Panel Array Mode 105
- Supported KVM Switches 106
 - Remote Access/Monitor Restriction 106
 - Remote Access 106
 - Remote Monitor 106
- Optional Rack Mounting 106
 - VE-RMK1U 106
- Session Usage When Working with KG Series 107
- ATEN Warranty Policy 108

About This Manual

This manual is provided to help you get the most out of your KVM over IP Console Station. It covers all aspects of the device, including installation, configuration, and operation.

The models covered in this manual include:

Model	Product Name
KA8270	VGA KVM over IP Console Station
KA8278	VGA / HDMI KVM over IP Console Station
KA8280	HDMI KVM over IP Console Station
KA8288	Dual HDMI KVM over IP Console Station

An overview of the information found in the manual is provided below.

Chapter 1, Introduction, introduces you to the KVM over IP Console Station, its purpose, features, and benefits, with its front and back panel components described.

Chapter 2, Hardware Setup, provides step-by-step instructions for setting up the KVM over IP Console Station, and explains some of its basic operation procedures.

Chapter 3, Operation, explains the fundamental concepts involved and provides a complete description of how to operate the product.

Chapter 4, Device Management, explains how to add or remove KVM over IP switches to or from the product.

Chapter 5, System Configuration, explains its system settings, which are categorized into General, ANMS, AD/LDAP, RADIUS, F/W Upgrade, Backup/Restore.

Chapter 6, Toolbar Interface, explains how to use the toolbar interface upon accessing a connected port.

Appendix, provides the technical and troubleshooting information at the end of the manual.

Note:

- ◆ Read this manual thoroughly and follow the installation and operation procedures carefully to prevent any damage to the unit or connected devices.

- ◆ The product may be updated, with features and functions added, improved, or removed since the release of this manual. For an up-to-date user manual, visit <http://www.aten.com/global/en/>
-

Conventions

This manual uses the following conventions:

- | | |
|---|--|
| Monospaced | Indicates text that you should key in. |
| [] | Indicates keys you should press. For example, [Enter] means to press the Enter key. If keys need to be chorded, they appear together in the same bracket with a plus sign between them: [Ctrl+Alt]. |
| 1. | Numbered lists represent procedures with sequential steps. |
| ◆ | Bullet lists provide information, but do not involve sequential steps. |
| > | Indicates selecting consecutive options (such as on a menu or dialog box). For example, Start > Run means to open the <i>Start</i> menu, and then select <i>Run</i> . |
|  | Indicates critical information. |

Chapter 1

Introduction

Overview

The ATEN KVM over IP Console Station (KA8270/KA8278/KA8280/KA8288) is a standalone console that replaces PC or NB, enabling users to remotely access, monitor, and control all servers connected to multiple ATEN's KVM over IP switches (please refer to the Compatible Products list on the website) with impenetrable security against virus threats. It also supports various types of data encryption for ensuring impervious data protection. The KVM over IP Console Station can be deployed to anywhere instant access and stringent security is required, and is ideal for applications such as studios, offices, data centers, broadcast stations, control rooms, and network operations centers (NOC).

KA8270, KA8278, KA8280, and KA8288 all support USB mouse/keyboard and two USB ports for Virtual Media function, and respectively support 1 VGA video output, 1 VGA plus 1 HDMI video outputs, 1 HDMI video output, and 2 HDMI video outputs at resolutions up to 1920 x 1200 @ 60 Hz. With KA8278 and KA8288, users can multitask across two displays with a single keyboard and mouse.

The KVM over IP Console Station is compatible with ATEN's KN KVM over IP Switch series. The KN KVM over IP Switches series are IP-based KVM control units that allow both local and remote operators to monitor and access multiple servers from a single console (refer to ATEN's website to get more information on the KVM over IP Switch).

In addition, the KVM over IP Console Station provides Panel Array Mode™ function, enabling administrators to monitor the video output of up to 64 servers simultaneously. The feature enables users to preview the contents of all desired ports at the same time, which is especially suitable for environments such as manufacturing and surveillance that often require monitoring of a much higher number of ports.

Among its enhanced functions, the extended desktop function can display remotely connected PCs on its dual screens, offering users a wider view during control. For easy collaboration between multiple KVM over IP Console Stations, the users can not only share screen contents from one console station to another, but also share the necessary contents to a big TV, for acknowledgment by all operators, during an urgent event. In addition, the

KVM over IP Console Station supports Telnet / SSH for management of console devices to allow users to have flexible control of all connected devices. To ensure security, its lock screen password function can effectively prevent unauthorized users from accessing an unattended console station to keep any critical data protected.

The KVM over IP Console Station can be set on a desk, mounted on a wall or at the rear of a rack with its space-saving 0U rack mount design. It is flexible and easy to install, and provides a GUI with multi-language support for device management, user profile customization, as well as hassle-free configuration for large deployments.

Note:Please refer to the *Compatible Products* section on the product web page for the list of compatible KVM over IP switches.

Features

- ◆ A standalone console that replaces PC or NB, enabling users to remotely access and control ATEN's KVM over IP switches (please refer to the Compatible Products list on the website)
- ◆ Impenetrable security against virus threats with impervious data protection
- ◆ Single sign-on to consolidate the management of multiple ATEN's KVM over IP switches (please refer to the Compatible Products list on the website)
- ◆ Advanced FPGA graphics processor — with a Full HD resolution of 1920 x 1200
- ◆ Supports 1 VGA video output (KA8270) or 1 HDMI video output (KA8280)
- ◆ Supports 1 VGA plus 1 HDMI video outputs (KA8278) or 2 HDMI video outputs (KA8288) — enables users to multitask across two displays with a single keyboard and mouse
- ◆ Panel Array Mode™ — allows administrators to monitor the video output of up to 64 servers on one screen simultaneously
- ◆ Supports Virtual Media (removable Disks and ISO files)
- ◆ Wall mountable — standard rack mount kit included
- ◆ Space-saving 0U rack mount design for rear mounting

- ◆ GUI with multi-language support — provides easy access and management, user profile customization, and flexible configuration for large deployments
- ◆ Supports USB smart card
- ◆ Supports Boundless Switching in Cascade with another KA8270 / KA8278 / KA8280 / KA8288
- ◆ Extended desktop — supports extended display for remotely connected PCs on the dual screens of KA8278 / KA8288
- ◆ Share screen — shares screen content from one console station to another for real-time collaboration
- ◆ Supports Telnet / SSH for connecting to and management of console devices
- ◆ Lock screen password — prevents unauthorized users from accessing the console station when unattended
- ◆ Supports RDP / VNC remote management for physical servers / virtual machines*

Note: The audio function is not supported and it will be available in future firmware updates.

Requirements

Console

- ◆ A VGA monitor (KA8270); an HDMI monitor (KA8280 or KA8288); a VGA or HDMI monitor (KA8278)
- ◆ A USB mouse
- ◆ A USB keyboard
- ◆ Microphone and speakers

Components

Front View

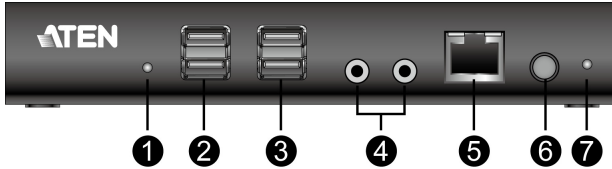

No.	Component
1	reset button
2	USB ports (peripherals)
3	USB ports (keyboard and mouse)
4	audio ports
5	cascade port
6	power pushbutton (press to stop video outputs; press again to resume video outputs)
7	power LED (power on: blue; video outputs off: orange)

Rear View

KA8270 Rear View

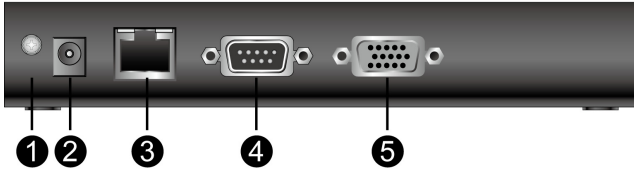

KA8278 Rear View

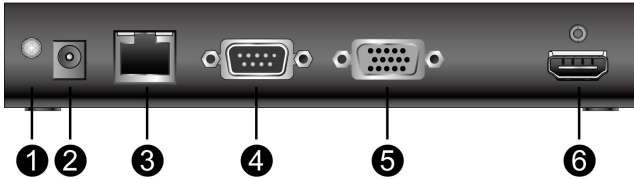

KA8280 Rear View

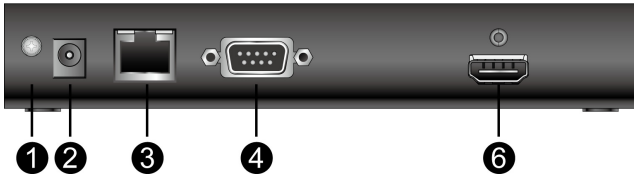

KA8288 Rear View

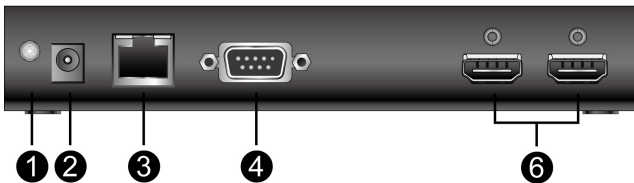

No.	Component
1	grounding terminal
2	power jack
3	LAN port (10/100/1000 Mbps)
4	COM port
5	VGA port (KA8270 and KA8278 only)
6	HDMI port(s) (KA8278, KA8280 and KA8288 only)

This Page Intentionally Left Blank

Chapter 2

Hardware Setup

Overview

This chapter outlines different ways of *mounting* your KVM over IP Console Station as well as a quick hardware *connection summary* for single-stage installation.

Before You Begin



1. Important safety information regarding the placement and grounding of this device is provided on page 97 and onwards. Please review it before proceeding.
2. Make sure that power to all the devices you will be connecting up have been turned off. You must unplug the power cords of any computers that have the Keyboard Power On function.
3. Please operate the device with caution when under high environmental temperatures, as the surface of the device may become overheated under such conditions. For instance, the surface temperature of the device may reach 70 °C (158 °F) or higher when the environmental temperature reaches close 50 °C (122 °F).

Mounting

The KVM over IP Console Station can be rack mounted or wall mounted. The following sections take you through the procedures for each method.

Rack Mount

The KVM over IP Console Station is designed to be mounted at the rear of a rack, where it occupies 0U to save space.

1. Remove two screws from the bottom of the unit and use them to attach the mounting bracket to the unit as shown in the diagram below:

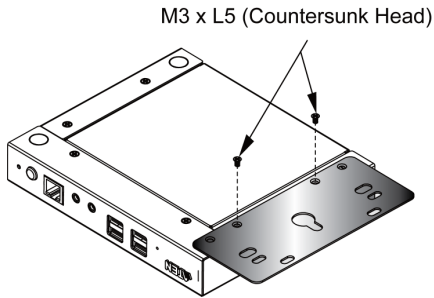

2. Screw the mounting bracket to any convenient location on the rack.

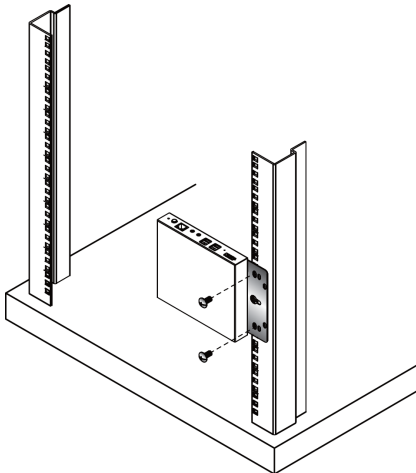

Note: Rack screws are not provided. The use of M5 x 12 Phillips type I cross screws is recommended.

Wall Mount

1. Remove two screws from the bottom of the unit and use them to attach the mounting bracket to the unit as shown in the diagram below:

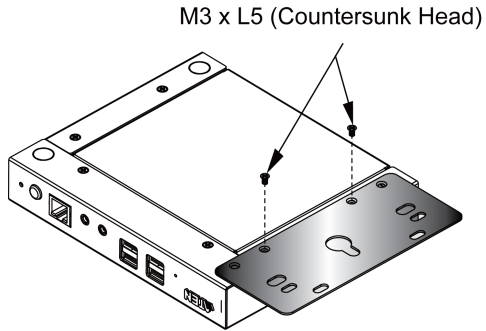

2. Use the mounting bracket's center screw hole to mount the unit onto a wall.

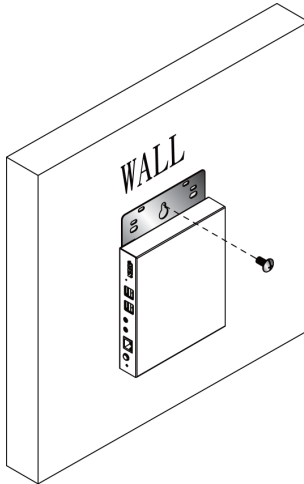

Single-Stage Installation

For single-stage installation, refer to the installation diagram and procedures below (KA8278 is used as an example):

Note: The numbers shown in the diagram correspond to the installation procedure step numbers.

1. Plug the connectors of your USB mouse, USB keyboard, microphone, and speakers into their respective ports on the front of the KVM over IP Console Station. Each port is color coded and marked with an icon.
2. Plug the monitor into the VGA or the HDMI port on the rear of the KVM over IP Console Station.

Note:

1. KA8270 supports 1 VGA video output, KA8278 supports 1 VGA and 1 HDMI video outputs, KA8280 supports 1 HDMI video output, and KA8288 supports 2 HDMI video outputs.
2. For models that support two video outputs (KA8278 and KA8288), the video interface at the inner side (e.g., the VGA video interface of KA8278) is the Primary Display, and the video interface at the outer side is the Secondary Display.
3. The Login page will appear on the Primary Display from which users can log in.
3. Plug an Ethernet cable from the LAN into the KVM over IP Console Station's LAN port.
4. (Optional) Plug USB drives into the dedicated USB ports located on the front panel.
5. (Optional) To cascade one more unit, plug one end of a Cat 5e cable into the cascade port on the front panel, and then plug the other end of the cable to the LAN port of another KVM over IP Console Station. The added unit will receive Internet connection from the first unit.

Configuration / control of each unit is separate.

Note: Do not connect the cascade port to a network switch or it will cause a switching loop.

6. (Optional) Use a grounding wire to connect the grounding terminal on the rear panel of the KVM over IP Console Station to a suitable grounded object.

7. Plug the power adapter into an AC source with the power cord; then plug the other end into the KVM over IP Console Station's power jack.

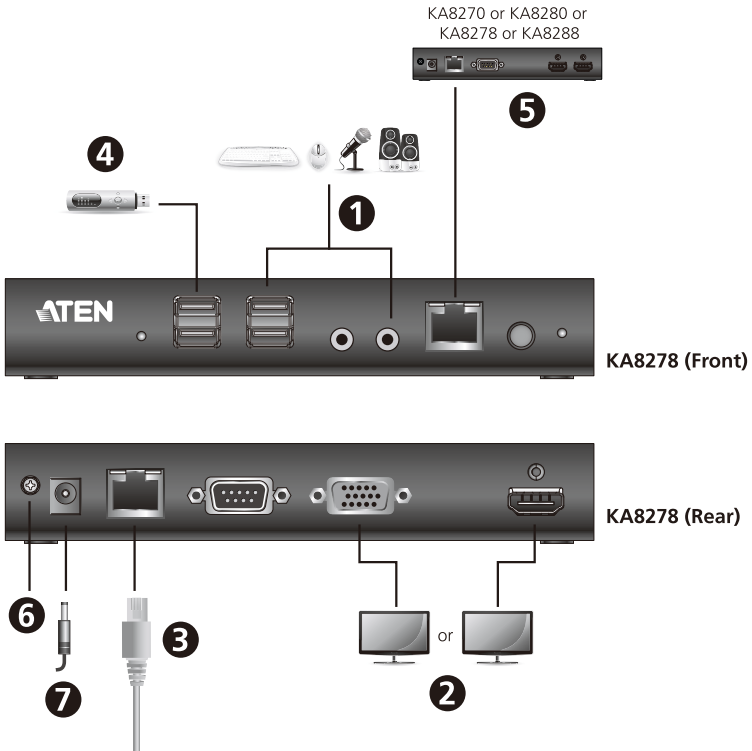

Hot Plugging

KVM over IP console stations support hot plugging — components can be removed and added back into the installation by unplugging and replugging cables from the ports without the need to shut the unit down.

Powering Off and Restarting

If it becomes necessary to power off the console station, please use the shut down function (see *Shutdown* on page 77), disconnect the power adapter and wait for 30 seconds before reconnecting it back.

Chapter 3

Operation

Overview

The KVM over IP console station can be used as a central control station to monitor several KVM switches. Available interfaces are described in the sections that follow.

Logging In

A valid Username and Password are required for login.

Note: If the number of invalid login attempts exceeds a specified number of times, a timeout period is invoked. You must wait until the timeout period expires before you can attempt to log in again. See *Login Failures* on page 62 for further details.

The KVM over IP console station supports two modes:

- a) Console station mode: Logging into the console station to manage KVM devices centrally. To manage the KG Series, we recommend using the console station mode.



The screenshot shows a login interface with a light green background. At the top, there is a dropdown menu labeled "Console Station" with a downward arrow. Below it are two text input fields: "User Name" and "Password". At the bottom center, there are two buttons: a blue "Login" button and a grey "Reset" button. In the bottom right corner, the word "English" is displayed.

- b) KVM over IP switch mode: Logging into a KVM device directly.

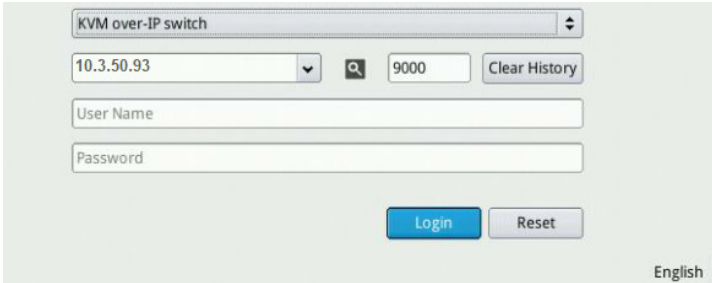

KVM over-IP switch

10.3.50.93 9000 Clear History

User Name

Password

Login Reset

English

- Note:**
1. Please use the KVM credentials to login.
 2. Click on “Clear History” to remove the history of all connected devices.
 3. When using the KVM over IP switch mode with the KG series, please mouse over to the top of the monitor and locate a down arrow symbol as shown. If you have connected two monitors on the KA82 Series and you cannot locate the down arrow on the first monitor, please try locate it on a second monitor.

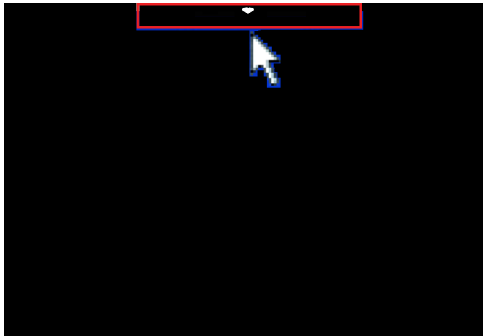

Follow the steps below to log in:

1. If you wish to log into a KVM device directly, select “KVM over-IP Switch” from the drop down menu, specify the device’s *IP address* and *port*, and go to the next step.

Or

For the KVM over IP console station login, select “Console Station” from the drop down menu and go to the next step.

Note: 1. As an alternative, you can drag your mouse over the magnifying glass symbol to find the addresses of the devices on the same local area network; or.

2. Click the drop-down menu for a device list. The device list shows the device login history. The history can be cleared using a terminal command, please see *Terminal* on page 73.

2. Enter a *Username* and *Password* (by default Username and Password are *administrator* and *password*, respectively) and click **Login**.

Note: For security purposes, you should change the Username and Password. (See *Users and Groups* on page 44)

3. (Optional) At the bottom-right corner, a language option is available (English is shown as it is the default language). Click to select a preferred language for the interface.

After you successfully login, the dashboard of the console station appears. Please refer to *Dashboard* on page 19 for details.

Upgrading KVM over IP Switch via Console Station

As new versions of the firmware become available, they can be downloaded from our website. Check the website regularly to find the latest information and packages for KVM over IP Switch.

To upgrade the KVM over IP Switch's firmware:

1. Get the newest firmware by downloading it from ATEN's website to a computer.
2. Transfer the downloaded file to a USB flash drive.

Note: Please use FAT file system formatted USB flash drive(s).

3. Remove the USB flash drive from the computer and insert it to a USB port of the console station.
4. From the console station's login page, select **KVM over-IP switch** from the drop-down menu, and specify the device's *IP address* and its *port*. Enter the *Username* and *Password* of the KVM over IP Switch and click **Login**.

ATEN | KA8270

KVM over-IP switch

192.168.1.148 9000 Clear History

administrator

Login Reset

English

5. From the KVM over IP Switch local console GUI main page, navigate to *Maintenance* and select **Upgrade Main Firmware**.

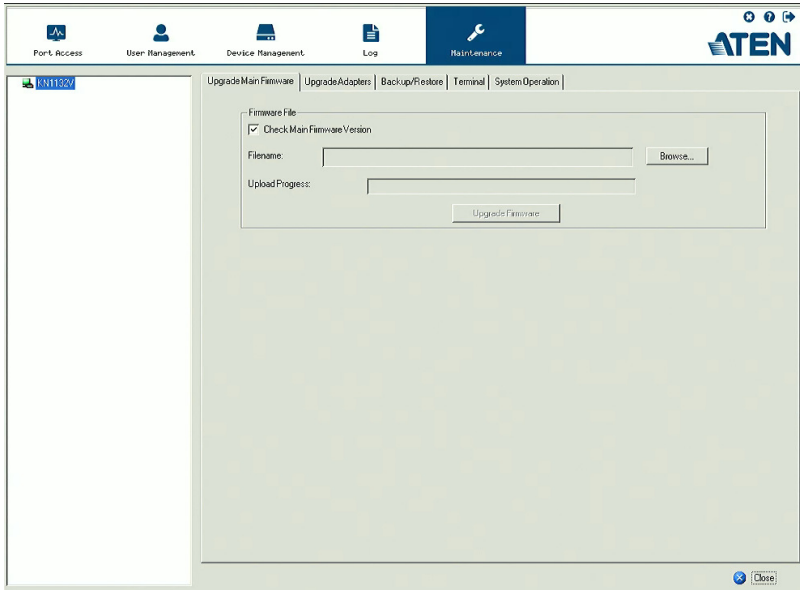

6. Click **Browse** to select the downloaded firmware file and click **Open**.

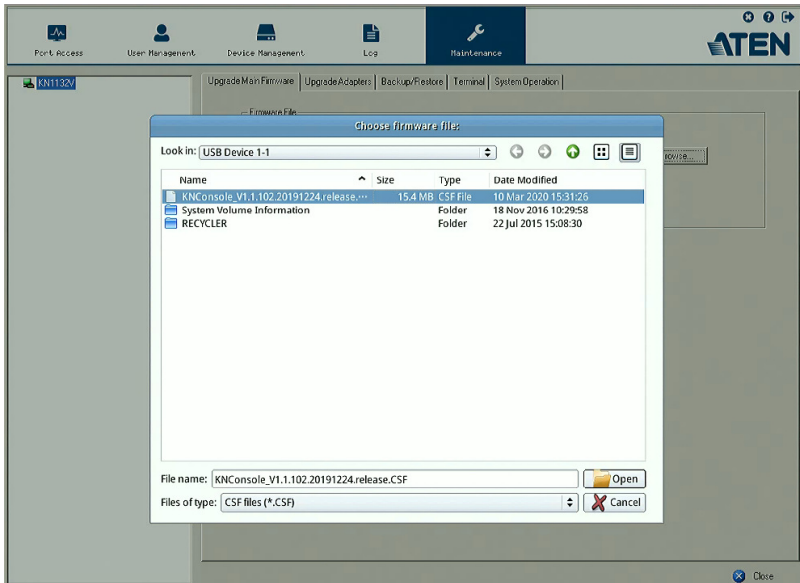

7. Click **Upgrade Firmware**.

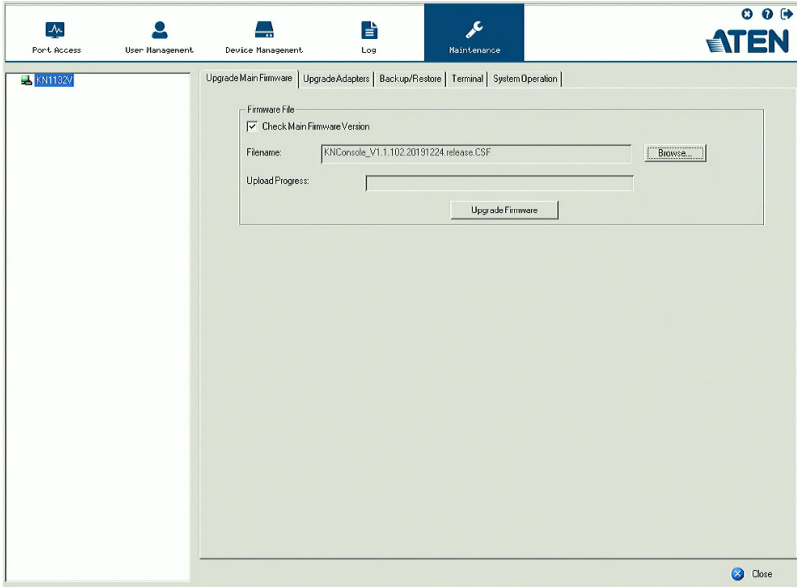

8. The KVM over IP Switch will reboot after the firmware upgrade is complete.

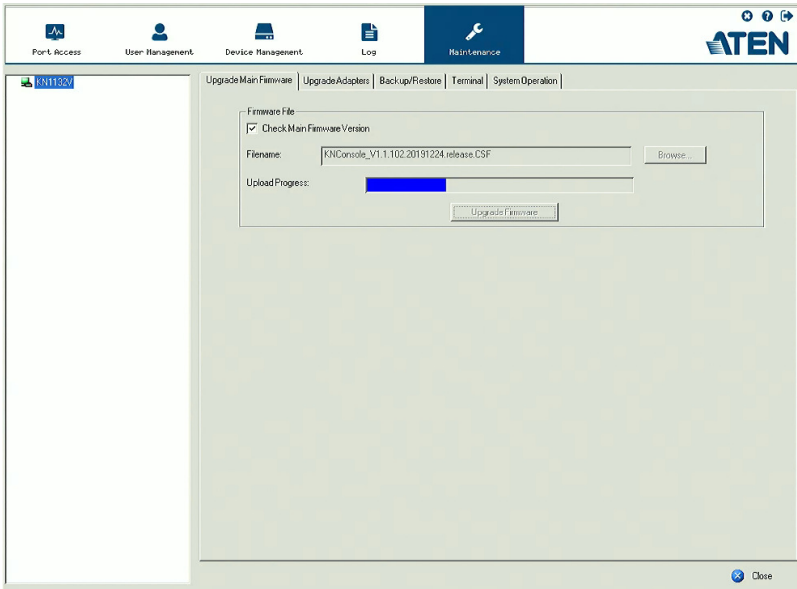

Dashboard

Once you have successfully logged in, the KVM over IP console station's user interface dashboard appears:

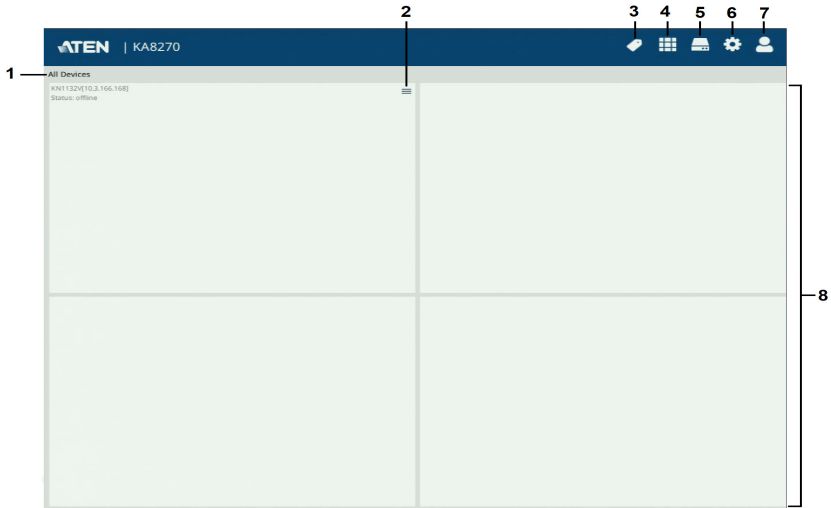

Note: The screen depicts an Administrator's page. Depending on the user's account type and permissions, not all of these elements will appear.

Page Components

The page components of the dashboard are described in the table below:

No.	Item	Description
1	All Devices	Clicking All Devices will bring out an option "Reconnect All Devices". Click the option for the reconnection operation. Note: This option is only available when the total number of devices added does not exceed 16.
2	Individual Monitor Option	Individual monitor option allows users to select which port is to be displayed on an assigned display, open the GUI or disconnect from the KVM over IP switch. If the switch is disconnected, you can also click Reconnect to reconnect the switch to the console station. For example, if you have a primary and secondary display (KA8278 or KA8288), you can choose to display one of the ports on the primary display while another port on the secondary display. See <i>Primary / Secondary Display</i> on page 22.

No.	Item	Description
3	Manage Device View	<p>Manage Device View allows users to separate KVM over IP switches currently being monitored into different device views to be displayed.</p> <p>Note: The maximum number of devices that can be displayed within a device view (including All Devices) is 16. If you have more than 16 devices added, make sure to create additional device views for displaying devices beyond 16.</p>
4	Manage Panel Array View	<p>Manage Panel Array View allows users to simultaneously display the ports connected to the KVM over IP switches. The ports can also be grouped into different groups and only simultaneously display the ports in the chosen group.</p>
5	Device Management	<p>Device management allows users with administrative authority to add devices to or remove devices from the console station.</p>
6	System Configuration	<p>System configuration allows users with administrative authority to manage users or groups, display device information, configure network, advanced network management (ANMS) or security settings, or manage firmware upgrade, system backup / restore, push / pull configurations to or from other devices, access terminal, or reset system to factory default settings.</p>
7	Administrator	<p>administrator allow users to change password, configure preferences, logout, restart the system, shut down the system, or display quick information about the console station.</p>
8	Available KVM over IP Switch Monitor	<p>Available KVM over IP switch monitor displays the available KVM over IP switch at a glance. Each monitor will consecutively rotate through the device's connected ports.</p>

Dashboard Operation

The dashboard of the console station usually displays the connected devices in an array of monitor units. Each of the unit corresponds to a connected device. The unit will continuously alternate between all connected ports.

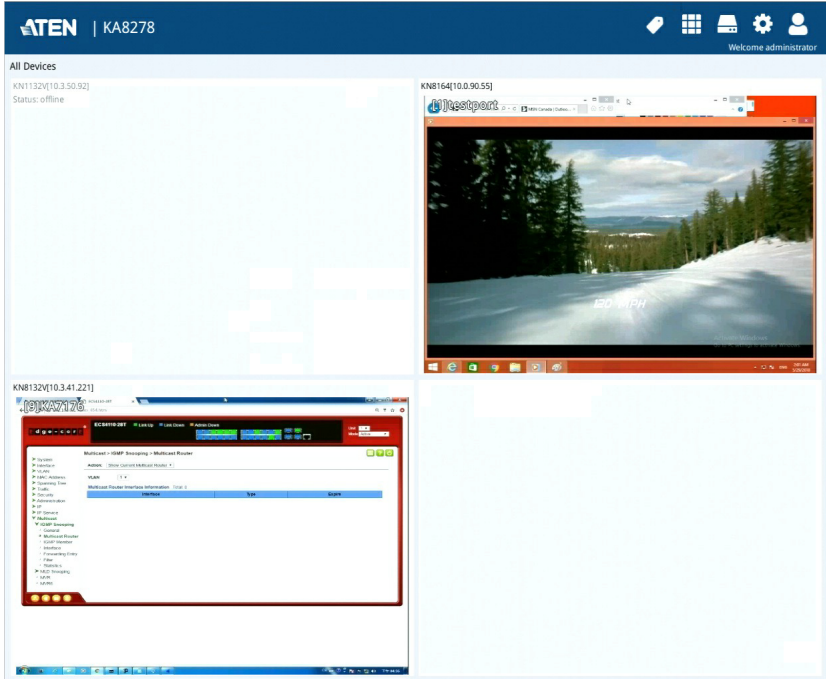

Double-clicking a monitor will bring you to the port's page.

For individual monitor options of a particular device, move your mouse over its corresponding monitor unit. A menu icon will be shown on the top-right corner of each unit.

 = Menu icon

Monitor Unit Option

Clicking the Menu icon displays available options:

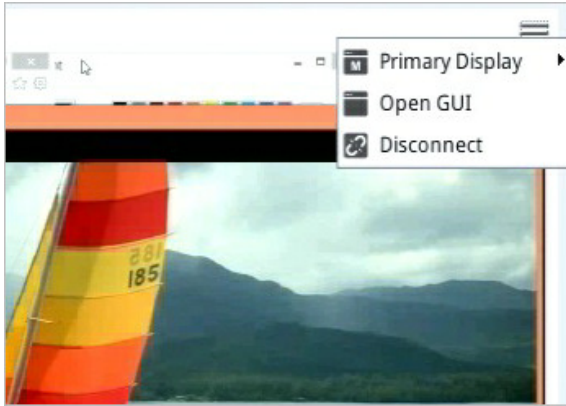

Primary / Secondary Display

Depending on your console station model (whether you have one or two display ports), the menu may show a Primary Display option or both a Primary Display option and a Secondary Display option, for displaying a port on the primary or secondary display:

1. Mouse over the display (primary or secondary):

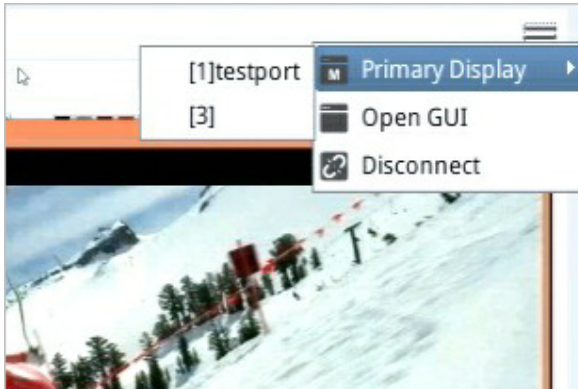

2. Click to select the port. The selected display should now show the port's screen. Your keyboard and mouse can now also control the server connected to the port.

For controlling the server, the KVM over IP console station's interface provides a toolbar to help you with the remote control operations. Please refer to *Toolbar Interface* on page 79.

GUI

If you wish to use the KVM over IP switch's GUI, click **Open GUI**. Please refer to the KVM switch's user manual for the GUI's operation.

Note: To upgrade the firmware of the KVM over IP Switch via the console station, see *Upgrading KVM over IP Switch via Console Station*, page 16.

Disconnect

Click **Disconnect** to disconnect from this KVM switch device.

Reconnect

Click **Reconnect** to reconnect to an offline KVM switch device.

Device / Panel Array View and Management

Manage Device View allows users to separate KVM over IP switches currently being monitored into different groups or select which device group is to be displayed on the dashboard.

Manage Panel Array View allows users to separate available ports into different groups or select which panel array group is to be displayed on the panel array page.

Device Options

Click the Device icon to display the device options.



Option	Description
Manage Device View	Click this option to add, delete, or modify custom device views.
All Devices	Click this option to display all connected KVM over IP switches on the dashboard.
Created Device View	Select a created device view to display the KVM over IP switches on the dashboard.

Device View

An example showing the KVM over IP switches in a device view is shown on the dashboard below (device 1 is the selected device):

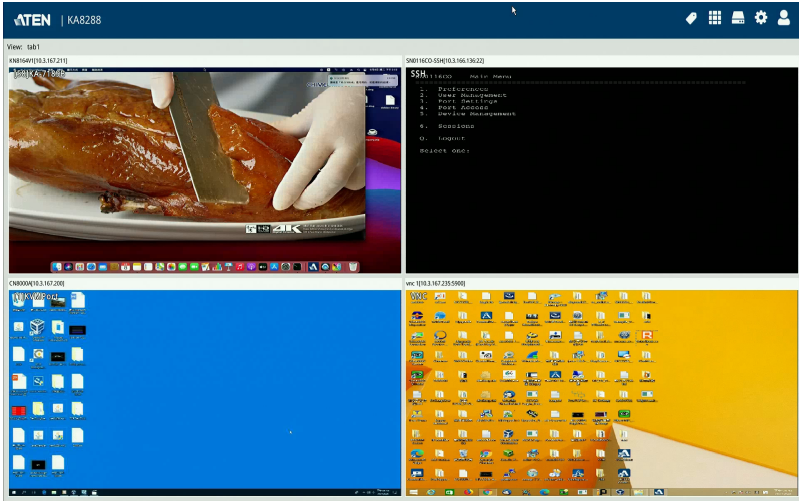

Note: The maximum supported devices that can be displayed in the device display is 16. For example, 20 CN9600 devices are connected to the KVM over IP console station and the device display is set to 64 ports (8 x 8), only 16 of the CN9600 devices can be displayed in one device view tab.

Panel Array Options

Click the Panel Array icon to display the panel array options:

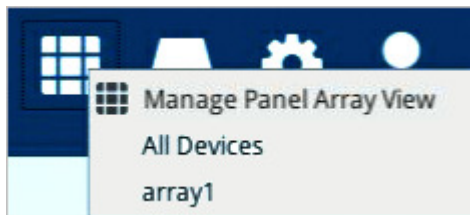

Option	Description
Manage Panel Array View	This option allows you to add, delete, or modify panel array (groups). The maximum number of panel array views can be created is 16.

Option	Description
All Devices	All ports of the connected KVM over IP switches are displayed on the panel array page.
Created panel arrays	Select a created panel array. All ports connected to the KVM over IP switches in the panel array are displayed.

Note: Audio is not supported.

Panel Array View

An example showing the ports of connected KVM over IP switches in a panel array view is displayed (array1 selected):

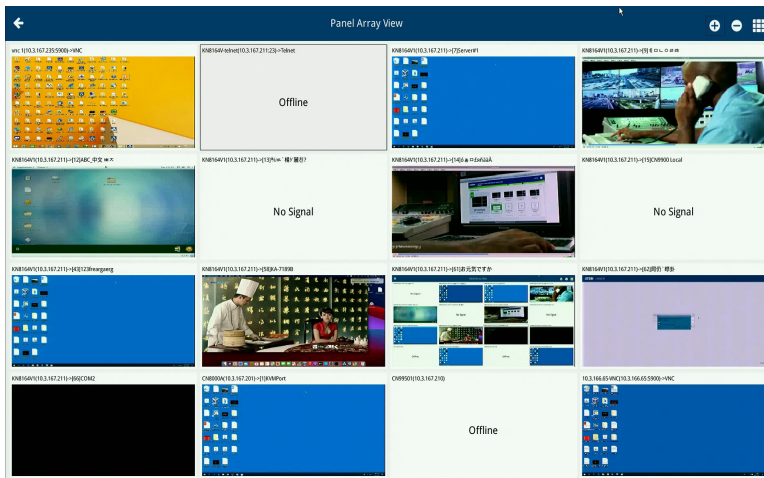

Press the + icon to display more device ports (up to 64 ports) on a smaller scale. Press the - icon to display less device ports on a larger scale. The diagram below displays an example of smaller scale.

Note: The maximum supported devices that can be displayed in the panel array is 16. For example, 20 CN9600 devices are connected to the KVM over IP console station and the panel array is set to 64 ports (8 x 8), only 16 of the CN9600 devices can be displayed in one panel array view page.

The panel array icon is also shown on the top-right corner of the panel array page. Clicking it will allow you to select which array you would like to display, or display all device ports:



Click the back arrow to go back to the dashboard.

Manage Device / Panel Array View

Click the Device or Panel Array icon to show their corresponding options. Due to their similarity, Manage Device View is used as the example below. Click **Manage Device View** (or **Manage Panel Array View**) for the following page:

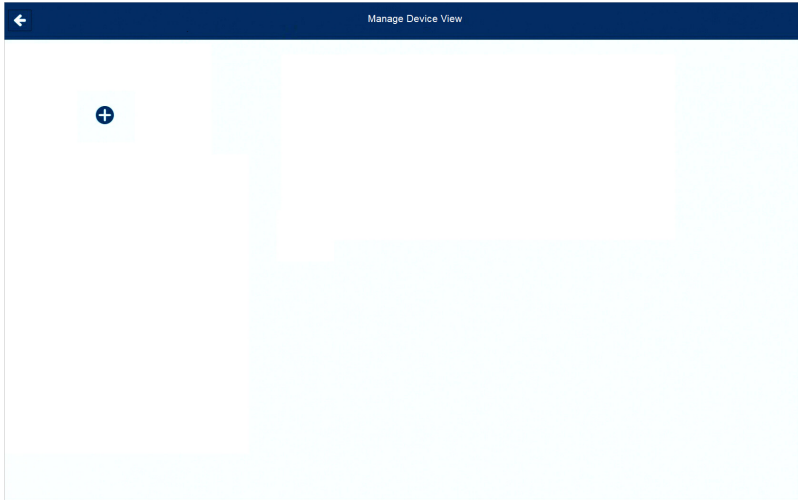

This page allows you to add / edit / delete device views.

Adding a Device / Panel Array View

1. To add a device / panel array view, click the + icon. A new window is displayed:

Note: The maximum number of panel array view can be created is 16.



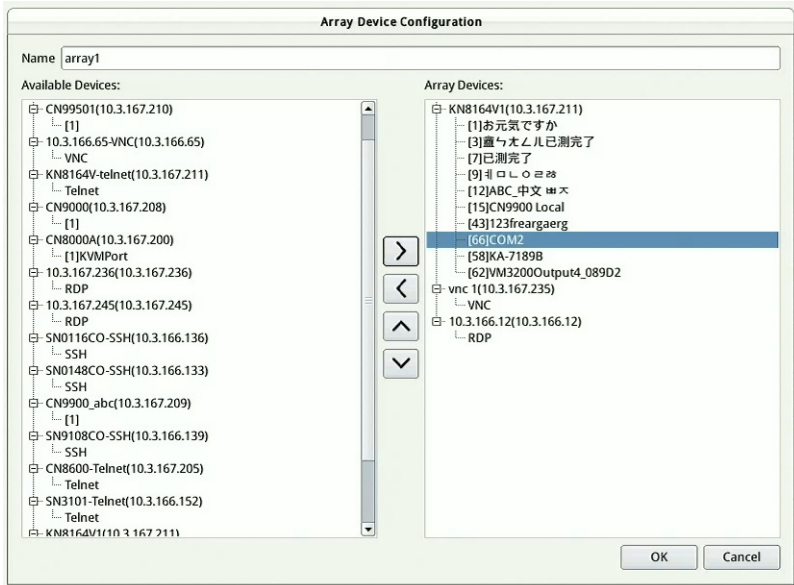

2. Enter a name for the new device / panel array view.

Note: The maximum number of character can be entered is 32.

3. Under *Available Devices*, select the devices you wish to add in this device / panel array view and click the > button. Alternatively, select any device you want to remove from this device / panel array view and click the < button.
4. Optionally change the order of the devices by clicking the up and down arrows.
5. Click **OK** to finish. The device view is shown:

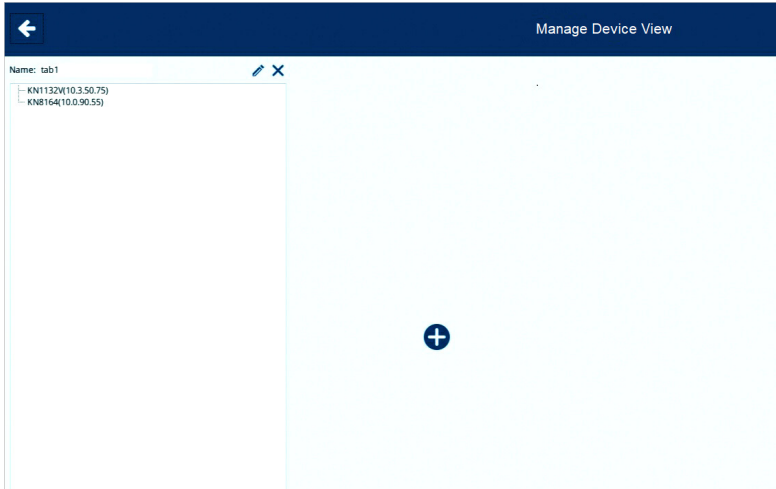

Adding another Device View

If you wish to add another device view, click the + icon again and go through the steps outlined in *Adding a Device / Panel Array View*.

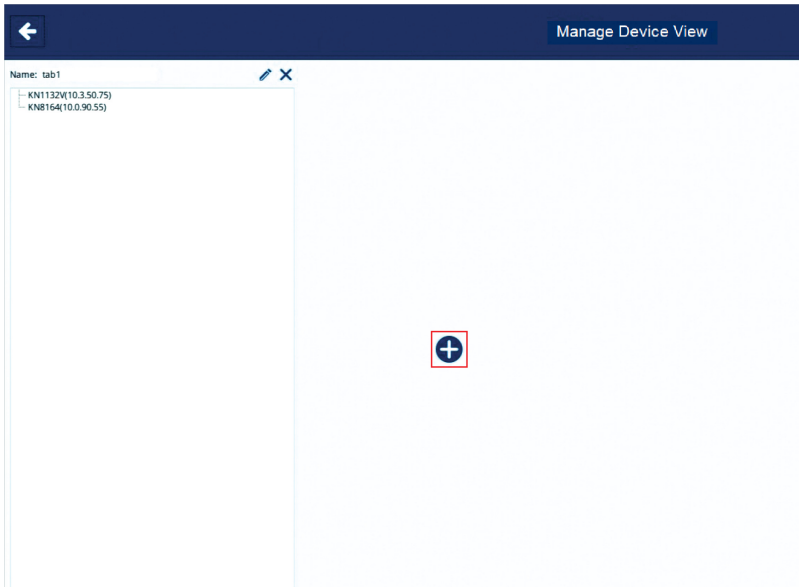

Editing a Device View

If you wish to edit a device view, click the pen icon beside the *Device View*.



The Tab Device Configuration window is displayed, as in *Adding a Device / Panel Array View*.

Edit its name, shift the devices around using the > or < icons and click **OK** when done.

Note: The maximum number of characters can be entered is 32.

Deleting a Device View

If you wish to delete a device view, click the X icon beside the *Device View*.



Boundless Switching with Cascade

Boundless Switching with cascade allows users to move mouse cursor across screens between two console stations. In boundless switching, the cascaded unit is controlled by the parent unit, and does not operate independently. Keyboard and mouse are required to connect to the parent unit for boundless switch to work.

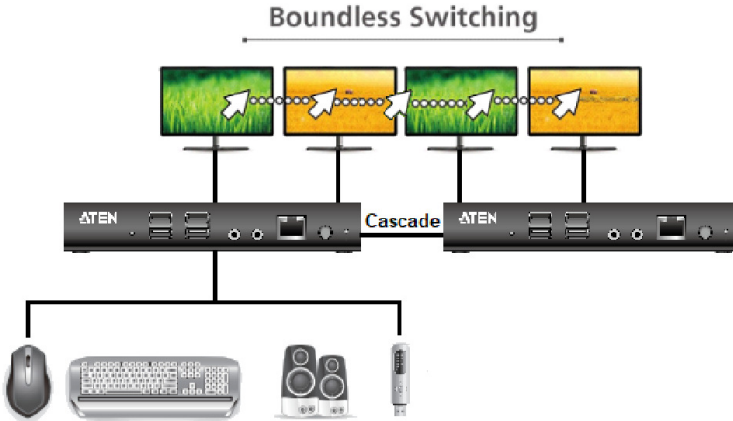

-
- Note:**
1. Boundless switching supports up to 4 displays between two console stations.
 2. It is unnecessary to cascade two console stations, boundless switching works as long as both console stations are within the same network segment.
 3. Audio output is delivered from the console station where the source screen is located. For example, the audio output is delivered from the cascaded unit if the audio source is coming from the 3rd display.
 4. Virtual media is supported from the console station where the source screen is located. For example, the virtual media is supported from the cascaded unit if the USB storage is mounted on it.
-

To set up boundless switching, please see *Cascade*, page 65.

Selecting a Display

To select a display, click on ☰ and the below page appears.

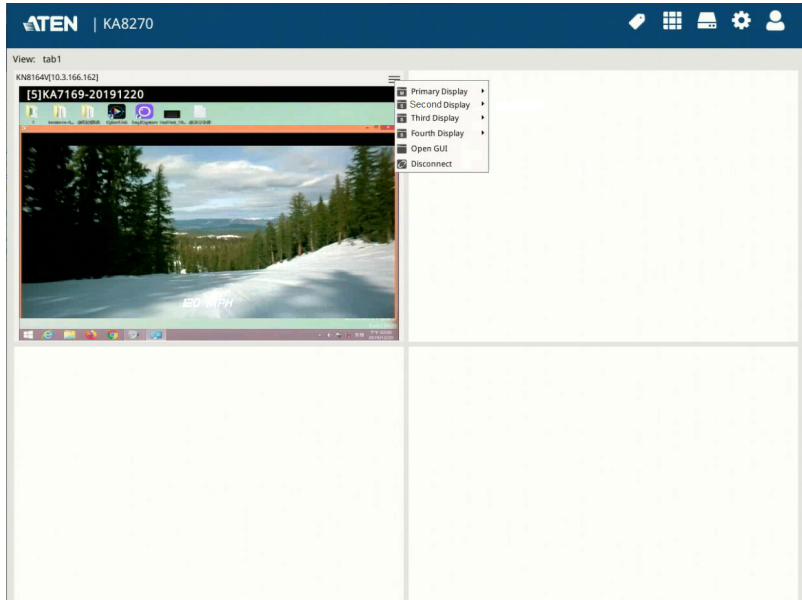

Stopping the Cascade

To stop the cascade, simply mouse over the cascaded screen and click **Stop Cascading**.

Note: If the cascade is disconnected, or one of the unit is powered off. The boundless switching will resume to the previous settings whenever the connection or power is reestablished.

Extended Desktop

Extended Desktop allows any remote servers connected via KN2116VA / KN4116VA / KN2124VA / KN4124VA / KN2132VA / KN4132VA / KN8132V / KN2140VA / KN4140VA / KN4164V / KN8164V / CN9000 / CN9600 / CN9950 (for CN Series, see *CN9600_CN9000_CN9950_user manual* for more information) that are configured as 2 video sources, in horizontal layout under Multi-View, to be displayed onto the dual screens of the KVM over IP console station as extended desktop upon access.

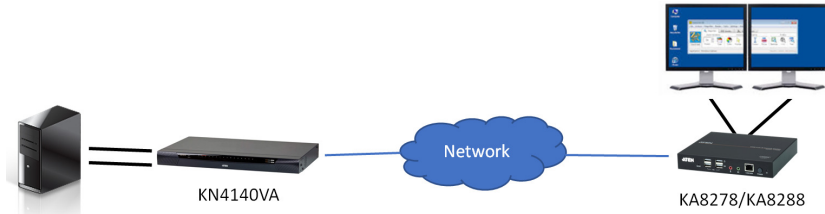

- Note:**
1. When using extended desktop, 2 buses of the KN2116VA / KN4116VA / KN2124VA / KN4124VA / KN2132VA / KN4132VA / KN8132V / KN2140VA / KN4140VA / KN4164V / KN8164V is used.
 2. The Extended Desktop function cannot be used in conjunction with Boundless Switching.
 3. For Extended Desktop to function properly, make sure of the following:
 - a. The mouse pointer must be set to manual mode.
 - b. Both of the video sources must have the same resolution settings, with *the size of text, apps, and other items* set to 100% under Windows' Display settings.
 - c. When configuring on the KN device, the numbers assigned to the video sources must correspond to that of Windows' Display settings.

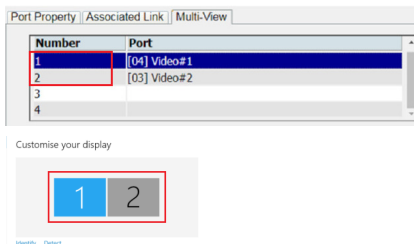

- When the mouse pointers are out of sync, between the remote servers and the KVM over IP console station, users can move the pointers to the toolbar section for resynchronization.



First, make sure the remote server's two video sources have been properly connected to and configured on the KN device, as illustrated below.

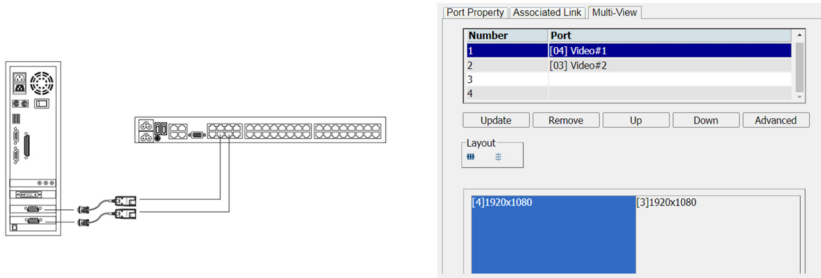

To access the extended desktop with KVM over IP console station, select any one of the 2 video sources., the primary or secondary display, as exemplified below.

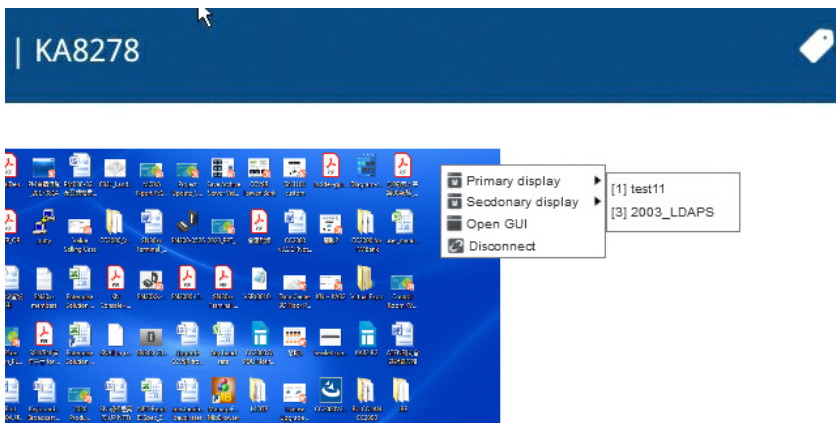

This Page Intentionally Left Blank

Chapter 4

Device Management

Overview

Device management allows users with administrative authority to add devices to or remove devices from the console station. The KVM over IP console station can manage up to 256 KVM over-IP switches and simultaneously display previews for up to 16 devices.

Note: The maximum number of devices that can be displayed within a device view (including All Devices) is 16. If you have more than 16 devices added, make sure to create additional device views for displaying devices beyond 16.



Click on the Device Management icon to enter its main page.

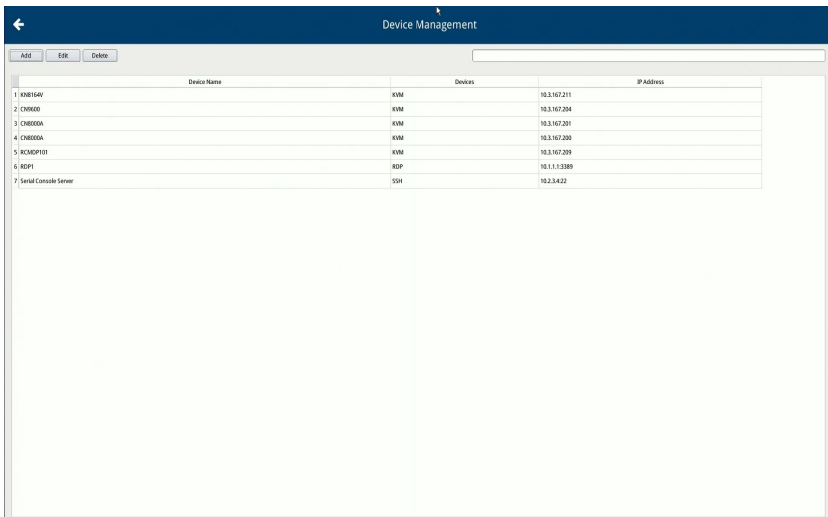

The screenshot shows the 'Device Management' interface. At the top, there is a navigation bar with a back arrow and the title 'Device Management'. Below the navigation bar, there are three buttons: 'Add', 'Edit', and 'Delete'. A search bar is located to the right of these buttons. The main content area displays a table with the following data:

Device Name	Devices	IP Address
1. CNB1000	KVM	10.3.167.211
2. CNB1001	KVM	10.3.167.204
3. CNB1006	KVM	10.3.167.207
4. CNB1006A	KVM	10.3.167.200
5. KCM30P011	KVM	10.3.167.209
6. RCP1	RDP	10.1.1.3389
7. Serial Console Server	SSH	10.2.3.422

Device List

The device list is displayed at the center of the Device Management page.

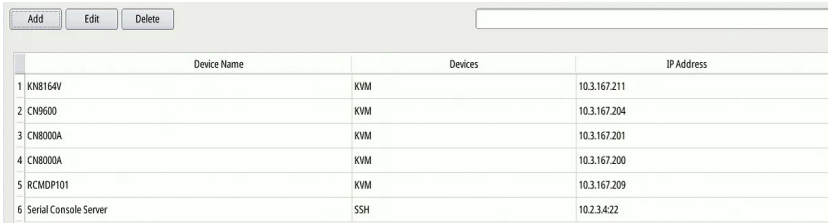

The screenshot shows a web interface for device management. At the top, there are three buttons: 'Add', 'Edit', and 'Delete'. Below these buttons is a search input field. The main content is a table with three columns: 'Device Name', 'Devices', and 'IP Address'. The table contains six rows of data.

	Device Name	Devices	IP Address
1	KN8164V	KVM	10.3.167.211
2	CN9500	KVM	10.3.167.204
3	CN8000A	KVM	10.3.167.201
4	CN8000A	KVM	10.3.167.200
5	RCMDP101	KVM	10.3.167.209
6	Serial Console Server	SSH	10.2.3.422

Search

The rectangular field at the top of the device list is the search box. Enter the IP address of the device you wish to search for to find that device.

Remove Device

If you wish to remove a device from the list, select it and click **Delete**.



Adding Devices

To add a device, click **Add**. The following options are displayed, as explained in the table below.

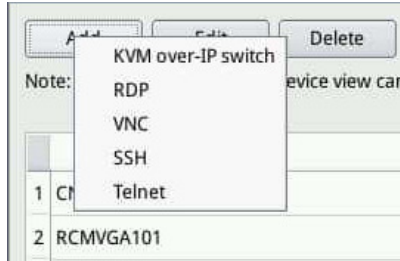

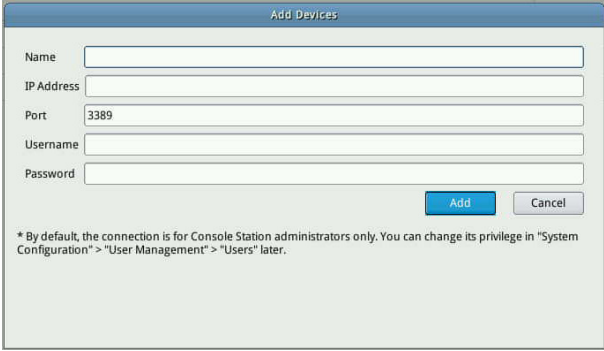
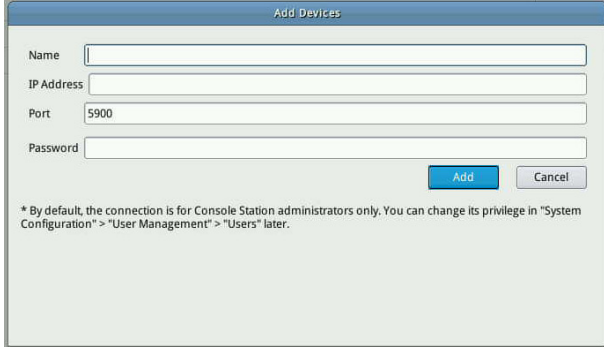
Option	Description
KVM over-IP switch	Click to add KVM over-IP switches (see <i>Adding KVM over-IP Devices</i> , page 41).
RDP	<p>Click to add serial console devices via RDP protocol for remote management.</p> 
VNC	<p>Click to add serial console devices via RDP protocol for remote management.</p> 

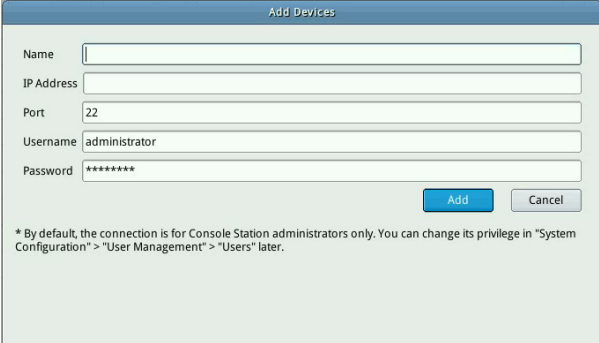
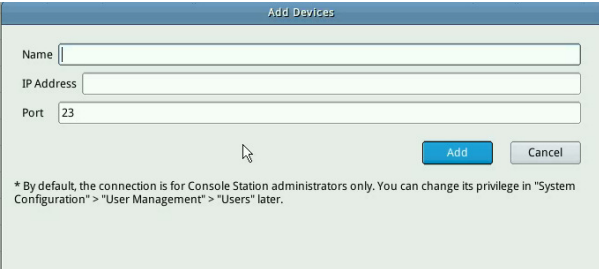
Option	Description
SSH	<p>Click to add serial console devices via SSH protocol for remote management.</p> 
Telnet	<p>Click to add serial console devices via Telnet protocol for remote management.</p> 

Adding KVM over-IP Devices

Mouse over the search button (magnifying glass). A list of KVM device(s) within the same local area network (LAN) will be shown, as exemplified below:

Device Name	IP Address	IPv6 Address
KN8132V	10.3.41.221	[fe80::210:74ff:feb5:12]

Select the desired device or simply enter the *IP address* of a known device; enter its *Username* and *Password*, and click **Save** to add the device to the system.

-
- Note:**
1. The entered username and password will determine the access rights of the KVM over-IP Switch.
 2. If you select the desired device by clicking the **Device Name** or **IP address** section, the displayed name will show the device's IPv4 address. If you click the IPv6 address section, its IPv6 address is displayed instead.
 3. If a KVM over-IP Switch is also added to CC2000 and has *Disable Local Authentication* enabled on the CC2000, the KVM over IP Console Station will not be able to access or control that switch.
-

Click **Reset** if you wish to re-enter the information.

The system will attempt to connect to the device. If successful, the device will be listed in the device list.

Changing Connection Information

If you wish to change the login account accessing an added device, for different access rights, you will need to change to a user with the desired access rights. Follow the steps below:

1. Select the device from the device list.
2. Edit the settings in the Device Information section:

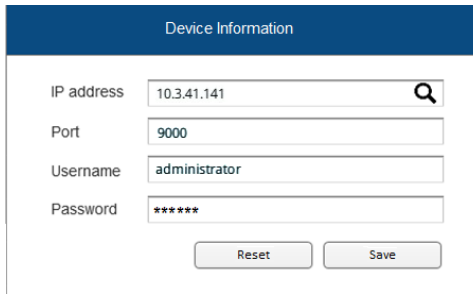

The screenshot shows a web form titled "Device Information" with a dark blue header. Below the header, there are four input fields: "IP address" with the value "10.3.41.141" and a search icon, "Port" with the value "9000", "Username" with the value "administrator", and "Password" with the value "*****". At the bottom of the form, there are two buttons: "Reset" and "Save".

3. Click **Save** to update the information.
4. Log out of the KVM over IP Console Station and log in again to see the updated settings / display / access right.

Chapter 5

System Configuration

Overview

System configuration allows users with administrative authority to manage users and groups, display device information, configure network, advanced network management (ANMS), security settings, manage firmware upgrade, system backup / restore, push / pull configurations to or from other devices, access terminal, and reset system to factory default settings.



Click on the System Configuration icon to enter its main page.

Property	Value
Device Name	K48278
MAC Address	08:00:27:4A:00:05:4E
Firmware Version	V1.0.062.20180320
IPSA	81A820180306.148042
IP Address	10.3.41.76
Subnet Mask	255.255.255.0
Gateway	10.3.41.254
Preferred DNS Server	10.0.1.7
Alternate DNS Server	10.0.1.6
IPv6 Address	688C:210:748F:FE0D:54e
IPv6 Subnet Prefix Length	64

The page consists of a side menu and a information / configuration body.

By default, device information is displayed upon entering system configuration, page as shown above.

If an item in the side menu has a + or - symbol, a submenu is available and can be expanded or collapsed. Expand the submenu by clicking the + symbol, and collapse the submenu by clicking the - symbol.

User Management

This section allows you to manage users and groups.

Users and Groups

Groups allow administrators to easily and efficiently manage users and devices. Since device access rights apply to anyone who is a member of the group, administrators only need to set them once per group, instead of having to set them for each user individually. Multiple groups can be defined to allow some users access to specific devices, while restricting other users from accessing them.

The KVM over IP console station supports two privilege categories as determined by “User Types”. User types are selected during user creation. The description is shown in the table below:

User Types	Role
Administrator	Access and manage devices. Manage Users and Groups. Configure the overall installation. Configure personal working environment.
User	Access authorized devices. Configure personal working environment.

Click “Users” or “Groups” under “User Management” in the side menu to bring out their respective configuration page.

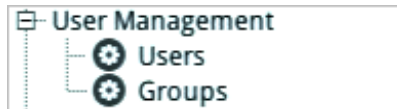

User Page

Name	Description	Status	Modify	Delete
1 administrator		Active		

Buttons: Add User, Copy User

Group Page

					Add Group	Copy Group
Name	Description	Status	Modify	Delete		
1 test1						

Add User

Since the management of users and groups are very similar, User is the example used for the operations below.

-
- Note:**
1. The maximum number of user can be created is 64.
 2. The maximum number of group can be created is 16.
-

To add a user:

1. Click “Add User” on the upper-right corner of the page.

					Add User	Copy User
Name	Description	Status	Modify	Delete		
1 administrator		Active				

The following will be displayed:

General
Group Members
Privilege

User Information

Username

Password

Confirm Password

Description

Allow Share Screen To Remote

Role

Administrator User

Status

Disable Account

User Must Change Password at Next Logon

User Cannot Change Password

2. Enter the required information in the appropriate fields. A description of the required user fields are given in the table below:

Field	Description
Username	1 to 32 characters are allowed depending on the Account Policy settings. See <i>Account Policy</i> on page 63.
Password	0 to 32 characters are allowed depending on the Account Policy settings. See <i>Account Policy</i> on page 63.
Confirm Password	To make sure there is no mistake in the password, please enter it again. The two entries must match.
Description	Additional information about the user that you may wish to include.
Allow Share Screen to Remote	Select to allow sharing of port screen contents to another KVM over IP Console Station within the network. Note: This function is enabled by default.
Role	There are two categories: Administrator and User. There is no limitation on the number of accounts that can be created in each category. The Administrator is responsible for the overall installation configuration and maintenance; user management; and device assignments. Each user assigned to administrator role will have the privilege of adding KVM over IP switches by default. Please refer to <i>Using User Configuration Page</i> on page 49.
Status	Status allows you to control the user's account and access to the installation, as follows: <ul style="list-style-type: none"> ◆ <i>Disable Account</i> lets you suspend a user's account without actually deleting it, so that it can be easily reinstated in the future. ◆ To require a user to change his password at the next logon, select <i>User must change password at next logon</i>. This can be used by the administrator to give the user a temporary password to log in for the first time, and then let the user set the password of his choice for future logins. ◆ To make a password permanent, so that the user cannot change it to something else, select <i>User cannot change password</i>.

If you choose Groups in the side menu, click Add Group for the page below:

A description of the required fields are given in the table below:

Field	Description
Group Name	Up to 32 characters are allowed.
Description	Additional information about the user that you may wish to include. A maximum of 45 characters is allowed.

- You can assign the new user to a group by selecting the *Groups* tab – the Groups page is discussed on page 50. You can also assign the user’s port access rights by selecting the *Devices* tab – the Devices page is discussed on page 53.

Note: Optionally, you can skip this step now to add more users and create groups, and come back to it later.

- When your selections have been made click **Save**.
- When the *Operation Succeeded* message appears, click **OK**.

Click *Back* on the upper-right corner of the configuration body or click *Users* in the side menu to return to the User Management page.

The newly added user will appear in the configuration body.

- The information / configuration body shows the username, the description that was given when the account was created, whether the account is currently active or has been disabled and give you the option to modify or delete the user.

Name	Description	Status	Modify	Delete
1 administrator		Active		
2 123456		Active		

Copy User

To save time creating a user with similar settings / information, you may use the Copy User function. A “Copy User” button is shown on the upper-right corner of the configuration body.



Name	Description	Status	Modify	Delete
1 administrator		Active		X

Select the user you wish to copy and click the “Copy User” button; follow the information in *Add User* to complete the configuration.

Modify User

If you wish to modify the user’s information, click the pen icon under the “Modify” column of the information / configuration body.

For configurable fields, please refer to *Add User* above.

Delete User

If you wish to delete a user, click the X icon under the “Delete” column of the information / configuration body.

The system will ask for confirmation as shown below:

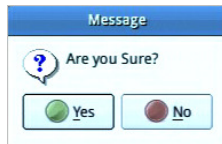

Click “Yes” to go ahead, or “No” to cancel action.

Managing (Assigning) Users and Groups

There are two ways to assign users to groups: from the Users configuration page; and from the Group configuration page.

Note: Before you can assign users to groups, you must first create them. See *Add User* on page 45 for details.

Using User Configuration Page

Follow the steps below to go to the User’s configuration page:

1. Click “Users” under “User Management” in the side menu to bring out the configuration page.
2. Click the pen icon under the “Modify” column.
3. In the configuration page, select the *Group Members* tab as shown:

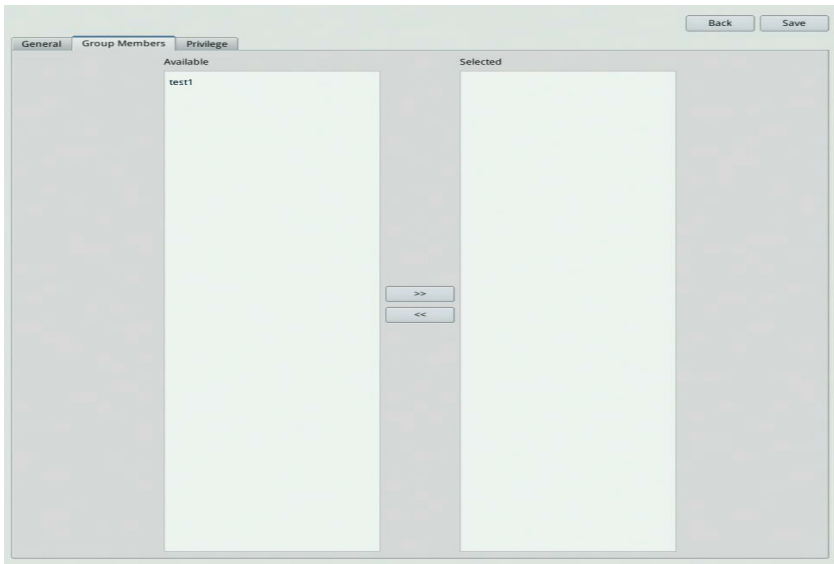

Assign a User to a Group

1. In the *Available* column, select the group that you want the user to be in.
2. Click the >> icon button to put the group’s name into the *Selected* column to *add the user to group*.
3. Repeat the above for any other groups that you want the user to be in.
4. Click **Save** when you are done.

Remove Users from a Group

1. In the *Selected* column, select the group that you want the user to be removed from.
2. Click the << icon button to remove the group's name from the *Selected* column to *remove the user from the group*.
3. Repeat the above for any other groups that you want the user to be removed from.
4. Click **Save** when you are done.

Using Group Configuration Page

Follow the steps below to go to the Group's configuration page:

1. Click "Groups" under "User Management" in the side menu to bring out the configuration page.
2. Click the pen icon under the "Modify" column.
3. In the configuration page, select the *Members* tab as shown:

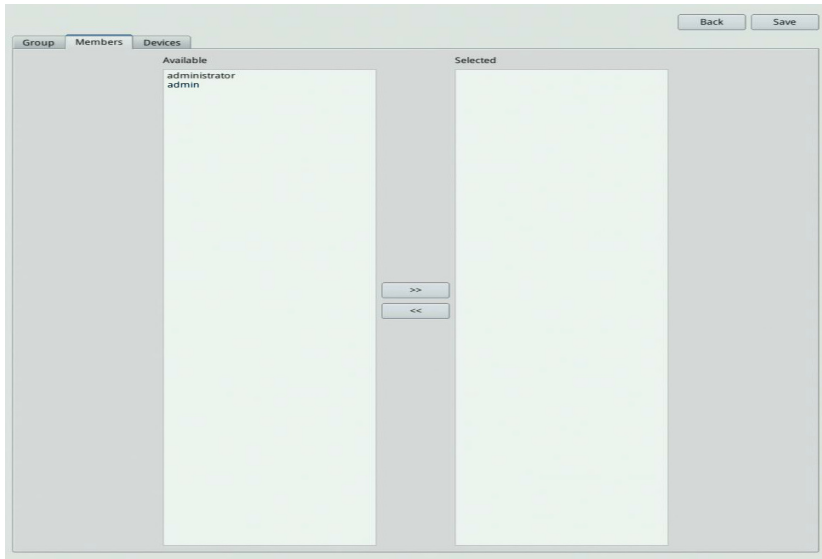

Assign Users to a Group

1. In the *Available* column, select the members (users) that you want the group to have.

2. Click the >> icon button to put the members into the *Selected* column (thereby adding into the group).
3. Repeat the above to assign members to each group.
4. Click **Save** when you are done.

Remove Users from a Group

1. In the *Selected* column, select the members (users) to be removed from the group.
2. Click the << icon button to put the members into the *Available* column (thereby removing from the group).
3. Repeat the above to remove members from each group.
4. Click **Save** when you are done.

Device Assignment

This function assigns access rights to users or groups and can be achieved from Device configuration page. Administrators can assign users to a particular user's privileges of an added KVM over IP Switch and access ports.

Using Device Configuration Page

Follow the steps below to go to the User's configuration page:

1. Click "Users" under "User Management" in the side menu to bring out the configuration page.
2. Click the pen icon under the "Modify" column.
3. In the configuration page, select the *Privilege* tab as shown:

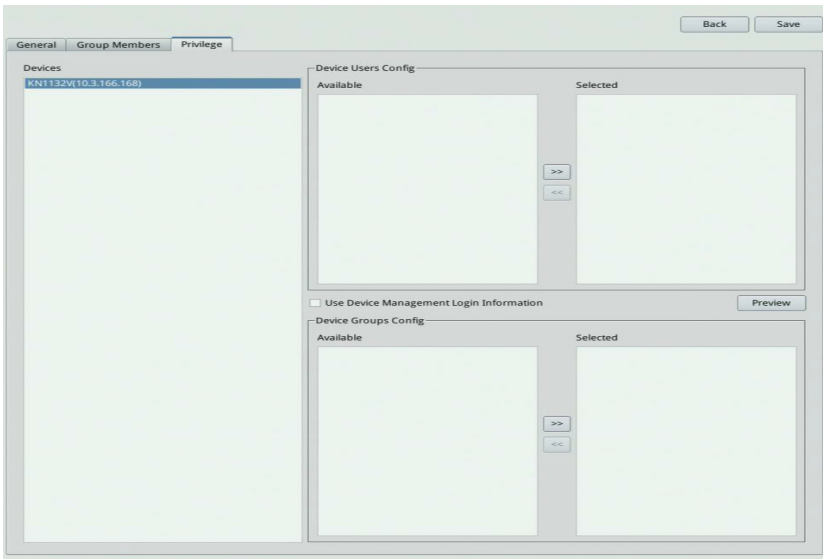

Each of the elements on this page is described below.

Devices

- ♦ The list displays the currently available device(s).
- ♦ When there is a change in the user accounts and groups for a device, please click the "Refresh" icon to refresh the user list of that device.

Device Users Config

- ◆ After selecting a device, the *Available* column (left column) lists the available users (of the device).
- ◆ The *Selected* column (right column) shows the selected user (of the device).
- ◆ Click the >> or << icon buttons to shift between *Available* and *Selected*.
- ◆ The user/group of the console station will gain the permission of the selected user (of the device).
- ◆ Each KVM over IP console station user can only be assigned to one user account privilege of the KVM over IP switch device.

Device Group Config

- ◆ After selecting a device, the *Available* column (left column) lists the available groups (of the device).
- ◆ The *Selected* column (right column) shows the selected groups (of the device).
- ◆ Click the >> or << icon buttons to shift between *Available* and *Selected*.
- ◆ The user/group of the console station will gain the permission of the selected groups (of the device).

User Device Management Login Information

- ◆ Checking this will block all selections in the Device Users Configuration and Device Groups Configuration sections, and grant the access rights of the user used to add this device.
- ◆ Please refer to *Adding Devices* on page 38 with regards to the access rights.

Preview

- ◆ Clicking this button will show the access rights of the above selections as exemplified below:

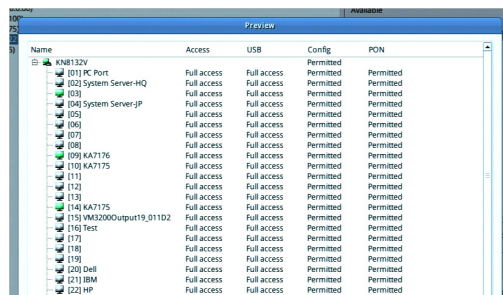

Name	Access	USB	Config	PON
KNB132V			Permitted	
013 PC Port	Full access	Full access	Permitted	Permitted
022 System Server-HQ	Full access	Full access	Permitted	Permitted
033	Full access	Full access	Permitted	Permitted
046 System Server-IP	Full access	Full access	Permitted	Permitted
055	Full access	Full access	Permitted	Permitted
066	Full access	Full access	Permitted	Permitted
072	Full access	Full access	Permitted	Permitted
086	Full access	Full access	Permitted	Permitted
099 KA7176	Full access	Full access	Permitted	Permitted
110 KA7175	Full access	Full access	Permitted	Permitted
111	Full access	Full access	Permitted	Permitted
112	Full access	Full access	Permitted	Permitted
118	Full access	Full access	Permitted	Permitted
114 KA7175	Full access	Full access	Permitted	Permitted
115 VM52000Output19_01102	Full access	Full access	Permitted	Permitted
116 Test	Full access	Full access	Permitted	Permitted
117	Full access	Full access	Permitted	Permitted
118	Full access	Full access	Permitted	Permitted
119	Full access	Full access	Permitted	Permitted
200 Dell	Full access	Full access	Permitted	Permitted
213 IBM	Full access	Full access	Permitted	Permitted
222 HP	Full access	Full access	Permitted	Permitted

Assigning RDP / VNC / SSH / Telnet Device Access to Users

By default, any devices added via RDP / VNC / SSH / Telnet can only be accessed by Administrator accounts. Under RDP and VNC connection, only normal mouse and keyboard operation such as office work is recommended.

To allow access of a such devices for a User, select the device under the *Privilege* tab as shown below.

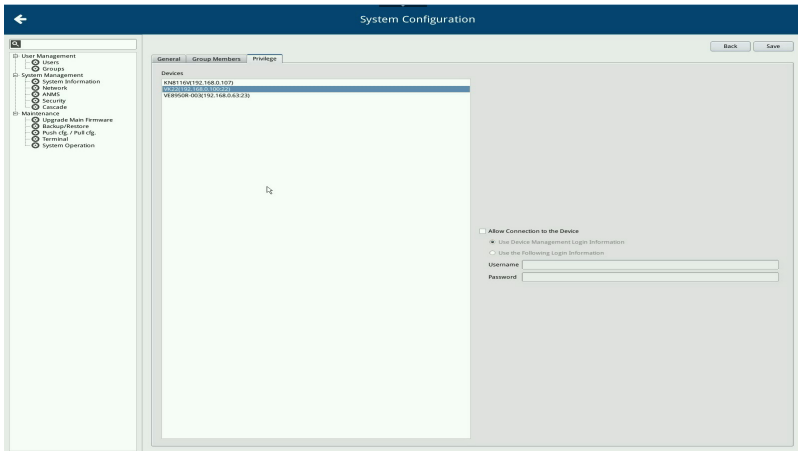

On the right of the configuration page, check the **Allow Connection to the Device** option to allow access to this device for the User, and select one of the following:

- ◆ Use Device Management Login: use the same login credentials as configured within Device Management for accessing the serial console device.
- ◆ Use the Following Login Information: use another set of login credentials for accessing the serial console device, by entering the Username and Password.

System Management

This page shows device information and allows you to configure network, ANMS and security settings.

Note: Whenever a new setting is saved, the system will reboot.

System Information

Click “System Information” under “System Management” in the side menu to bring out the information page.

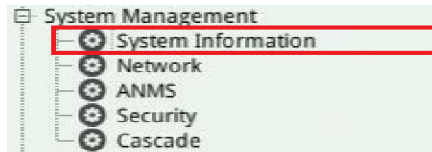

Device Name	KA8270
MAC Address	00-10-74-17-81-01
Firmware Version	V1.1.102.20191224
FPGA	Build20191210.151114
IP Address	192.168.0.60
Subnet Mask	255.255.255.0
IPv6 Address	fe80::210:74ff:fe17:8101
IPv6 Subnet Prefix Length	64

The System Information page displays the name of the selected device, its firmware version, the FPGA (Field-Programmable-Gate-Array) and information about its network configuration.

Double-click the Device Name (KA8278 in our example) to change the device name.

Network

The Network page is used to specify the network environment.

Click “Network” under “System Management” in the side menu to bring out the information page.



The image shows two screenshots from a KVM over IP console station. The top screenshot is a 'System Management' menu with a red box around the 'Network' option. The bottom screenshot is the 'IP Installer' configuration window, which is currently set to 'Enabled'. It contains sections for IPv4 and IPv6 settings, including IP address, subnet mask, gateway, and DNS server options. A 'Save' button is at the bottom.

System Management

- System Information
- Network**
- ANMS
- Security
- Cascade

IP Installer

Enabled View Only Disabled

IPv4 Settings

IP Address

Obtain IP address automatically [DHCP]
 Set IP address manually [Fixed IP]

IP Address: 192.168.0.60

Subnet Mask: 255.255.255.0

Gateway: 0.0.0.0

DNS Server

Obtain DNS server address automatically
 Set DNS server address manually

Preferred DNS Server: 0.0.0.0

Alternate DNS Server: 0.0.0.0

IPv6 Settings

IPv6 Address

Obtain IPv6 address automatically [DHCP]
 Set IPv6 address manually [Fixed IP]

IPv6 Address: fe80::210:74ff:fe17:8101

IPv6 Subnet Prefix Length: 64

Gateway:

DNS Server

Obtain DNS server address automatically
 Set DNS server address manually

IPv6 Preferred DNS Server:

IPv6 Alternate DNS Server:

Save

Each of the elements on this page is described below.

IP Installer

The IP Installer is an external Windows-based utility for assigning IP addresses to the KVM over IP switch.

Click one of the radio buttons to select *Enable*, *View Only*, or *Disabled* for the IP Installer utility. See *IP Installer*, page 268, for IP Installer details.

Note:

1. If you select *View Only*, you will be able to see the KVM over IP switch in the IP Installer's Device List, but you will not be able to change the IP address.
2. For security, we strongly recommend that you set this to *View Only* or *Disable* after each use.

IPv4 Settings

■ IP Address:

IPv4 is the traditional method of specifying IP addresses. The KVM over IP Console Station can either have its IP address assigned dynamically (DHCP), or it can be given a fixed IP address.

- ◆ For dynamic IP address assignment, select *Obtain IP address automatically* (**default**).
- ◆ To specify a fixed IP address, select *Set IP address manually* and fill in the fields with values appropriate for your network.

Note:

1. If you choose *Obtain IP address automatically*, when the console station starts up it waits to get its IP address from the DHCP server. If it has not obtained the address after one minute, it automatically reverts to its factory default IP address (192.168.0.60.)
2. If the switch is on a network that uses DHCP to assign network addresses, and you need to ascertain its IP address, see *Supported KVM Switches* on page 106 for information.

■ DNS Server

- ◆ For automatic DNS Server address assignment, select *Obtain DNS Server address automatically*.
- ◆ To specify the DNS Server address manually, select *Set DNS server address manually*, and fill in the addresses for the Preferred and Alternate DNS servers with values appropriate for your network.

Note: Specifying the Alternate DNS Server address is optional.

IPv6 Settings

At present, the KVM over IP console station supports three IPv6 address protocols: Link Local IPv6 Address, IPv6 Stateless Autoconfiguration, and Stateful Autoconfiguration (DHCPv6).

■ IP Address:

IPv6 is the new (128-bit) format for specifying IP addresses. The KVM over IP console station can either have its IPv6 address assigned dynamically (DHCP), or it can be given a fixed IP address.

- ◆ For dynamic IP address assignment, select *Obtain IP address automatically* (**default**).
- ◆ To specify a fixed IP address, select *Set IP address manually* and fill in the fields with values appropriate for your network.

■ DNS Server

- ◆ For automatic DNS Server address assignment, select *Obtain DNS Server address automatically*.
- ◆ To specify the DNS Server address manually, select *Set DNS server address manually*, and fill in the addresses for the Preferred and Alternate DNS servers with values appropriate for your network.

Note: Specifying the Alternate DNS Server address is optional.

Finishing Up

After making any network changes, be sure to click “Save” at the bottom of the configuration page.

ANMS

The ANMS (Advanced Network Management Settings) page is used to set up login authentication and authorization management from external sources.

Click “ANMS” under “System Management” in the side menu to bring out the information page.

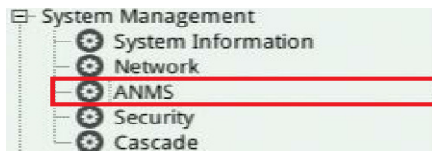

The image shows a configuration window with two main sections: "RADIUS Settings" and "AD/LDAP Settings".

RADIUS Settings:

- Enable
- Preferred RADIUS: [Dropdown menu]
- Server IP: [Text input field]
- Service Port: [Text input field]
- Same as Preferred Setting
- Authentication Type: [Dropdown menu, currently showing PAP]
- Timeout: [Text input field] sec
- Retries: [Text input field]
- Shared Secret: [Text input field]

AD/LDAP Settings:

- Enable
- Preferred LDAP: [Dropdown menu]
- Server IP: [Text input field]
- Service Port: [Text input field]
- Same as Preferred Setting
- Server requires secure connection(SSL)
- Timeout: [Text input field] sec
- Admin DN: [Text input field]
- Admin Name: [Text input field]
- Password: [Text input field]
- Search DN: [Text input field]

At the bottom of the window is a "Save" button.

RADIUS Settings

To allow authentication and authorization for the KVM over IP Console Station through a RADIUS server, do the following:

1. Check Enable.
2. Select Preferred or Alternate RADIUS server.
3. Fill in the IP addresses and service port numbers for the Preferred and Alternate RADIUS servers. You can use the IPv4 address, the IPv6 address or the domain name in the IP fields.
4. Select the *Authentication Type*: PAP or CHAP.

5. In the *Timeout* field, set the time in seconds that the KVM over IP console station waits for a RADIUS server reply before it times out.
6. In the *Retries* field, set the number of allowed RADIUS retries.
7. In the *Shared Secret* field, key in the character string that you want to use for authentication between the KVM over IP console station and the RADIUS Server. A minimum of 6 characters is required.
8. On the RADIUS server, Users can be authenticated with any of the following methods:
 - ◆ Set the entry for the user as **su/xxxx**
Where *xxxx* represents the Username given to the user when the account was created on the KVM over IP console station.
 - ◆ Use the same Username on both the RADIUS server and the KVM over IP console station.
 - ◆ Use the same Username name on both the RADIUS server and the KVM over IP console station.

In each case, the user's access rights are the ones assigned that were assigned when the User of Group was created on the KVM over IP console station (see *Adding Devices* on page 38).

AD / LDAP Settings

To allow authentication and authorization for the KVM over IP console station via AD / LDAP, refer to the information in the table, below:

Item	Action
Enable	Check the checkbox to enable AD / LDAP authentication and authorization.
Type	Click the drop down menu to select between AD / LDAP.
Server IP	Select Preferred or Alternate LDAP Server and fill in the IP address and port number for the LDAP or LDAPS server. You can use the IPv4 address, the IPv6 address or the domain name in the <i>LDAP Server</i> field. For LDAP, the default port number is 389.
Timeout	This is the time in seconds that the KVM over IP console station waits for an AD or LDAP server reply before it times out.

Item	Action
Admin DN	Consult the AD / LDAP administrator to ascertain the appropriate entry for this field. For example, the entry might look like this: ou=kn8132,dc=aten,dc=com
Admin Name	Key in the administrator username.
Password	Key in the administrator password.
Search DN	Set the distinguished name of the search base. This is the domain name where the search starts for user names.

LDAP attribute is required for complete setup. LDAP attribute can be retrieved from the GET command using the Terminal interface. Please refer to *Terminal* on page 73 for more details.

On the AD / LDAP server, users can be authenticated with any of the following methods:

- ◆ With MS Active Directory schema.
- ◆ Without schema – Only the Usernames used on the KVM over IP console station are matched to the names on the LDAP server. User privileges are the same as the ones configured on the switch.
- ◆ Without schema – Only Groups in AD are matched. User privileges are the ones configured for the groups he belongs to on the switch.
- ◆ Without schema – Usernames and Groups in AD are matched. User privileges are the ones configured for the User and the Groups he belongs to on the switch.

Note: For more information on configuring LDAP, you can download the full LDAP instructional manual from our website.

Finishing Up

After making any ANMS changes, be sure to click “Save” at the bottom of the configuration page.

Security

The Security page is divided into 3 main panels, as described in the sections that follow.

Click “Security” under “System Management” in the side menu to bring out the information page.

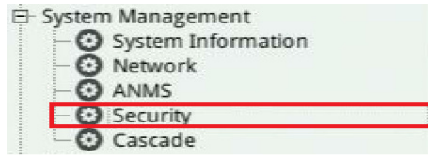

Login Failures

Enable

Allowed

Timeout min

Account Policy

Minimum Username Length

Minimum Password Length

Password Must Contain At Least

One Upper Case

One Lower Case

One Number

Enforce Password History

Working Mode

Enable ICMP

Allow Push Request From Remote

Allow Pull Request From Remote

Confirm Before Receiving Shared Screen From Remote

Log out when Pressing POWER button

Console Keyboard Language

Login Failures

For increased security, the Login Failures section allows administrators to set policies governing what happens when a user fails to log in successfully. To set the Login Failures policy, check the *Enable* checkbox (the default is for Login Failures to be enabled). The meanings of the entries are explained in the table below:

Entry	Explanation
Allowed	Sets the number of consecutive failed login attempts that are permitted from a remote computer. The default is 5 times.
Timeout	Sets the amount of time a remote computer must wait before attempting to login again after it has exceeded the number of allowed failures. The default is 3 minutes.

Note: If Login Failures is not enabled, users can attempt to log in an unlimited number of times with no restrictions. For security purposes, we recommend that you enable this function and enable the lockout policies.

Account Policy

In the Account Policy section, system administrators can set policies governing usernames and passwords.

The meanings of the Account Policy entries are explained in the table below:

Entry	Explanation
Minimum Username Length	Sets the minimum number of characters required for a username from 1 to 32. The default is 6.
Minimum Password Length	Sets the minimum number of characters required for a password from 0 to 32. A setting of 0 means that no password is required. Users can login with only a username. The default is 6.
Password must Contain at least	Checking any of these items requires users to include at least one uppercase letter, one lowercase letter, or one number in their password. Note: This policy only affects user accounts created after this policy has been enabled and password changes to existing user accounts.
Enforce Password History	Check this to disallow users from reusing the past passwords when defining a user account's new passwords, as compared with its password history.

Working Mode

An explanation of the Working Mode items is given in the table below:

Item	Explanation
Enable ICMP	Check / uncheck to allow / disallow the KVM over IP console station to be pinged. The default is Enabled.
Allow Push Request from Remote	Check / uncheck to allow / disallow another KVM over IP console station to push configuration or FW to your console station.
Allow Pull Request from Remote	Check / uncheck to allow / disallow another KVM over IP console station to pull configuration from your console station.
Confirm before Receiving Shared Screen from Remote	<ul style="list-style-type: none">◆ Check to notify and requiring a confirmation from the user before receiving a shared screen from other KVM over IP console stations.◆ Uncheck to automatically receive shared screen from other KVM over IP console stations without requiring a confirmation.
Log out when Pressing POWER button	<ul style="list-style-type: none">◆ Check to enable automatic logout upon pressing the console station's power button to turn its screen off and pressing again to turn it back on. Once logged out, the user is required to type the login credentials, and log in, again.◆ Uncheck to disable automatic logout upon pressing the console station's power button to turn its screen off and pressing again to turn it back on. When turning the screen back on, the user is required to type the account's password to resume where he/she left off.
Console Keyboard Language	Click the drop down menu to select the console's local keyboard language.

Finishing Up

After making any Security changes, be sure to click "Save" at the bottom of the configuration page.

Cascade

The Cascade page is used to set up the boundless switching with Cascade.

Click “Cascade” under “System Management” in the side menu to bring out the information page.

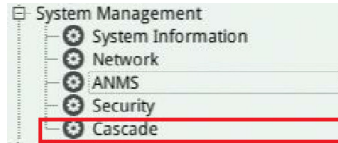

You can cascade with another Console Station for boundless switching that allow you to control between units' displays with one set of keyboard/mouse.

Enable cascade with boundless switching

IP Address

User Name

Password

Status: Not connected

Note: To cascade one more unit, plug one end of an Ethernet cable into the Cascade port on the front panel, and then plug the other end of the cable to the LAN port of another Console Station.

The meanings of the Cascade entries are explained in the table below:

Entry	Explanation
Enable cascade with boundless switching	Check/uncheck to enable/disable the cascade with boundless switching. The default is Disabled.
IP Address	Enter the IP address of the KA8270 / KA8278 / KA8280 / KA8288 that you wish to do boundless switching with your Parent Unit from.
User Name	Key in the administrator username.
Password	Key in the administrator password.
Status	Status shows the cascade connection from Not connected / Cascaded with KA8270, KA8278, KA8280, or KA8288(IP) / Connecting.

Finishing Up

After entering the required entries, be sure to click “Save”.

Maintenance

The *Maintenance* function is used to upgrade firmware; backup and restore configuration and account information; Push/pull configurations; send terminal commands, ping network devices; and restore default values.

Upgrade Main Firmware

As new versions of the firmware become available, they can be downloaded from our website. Check the website regularly to find the latest information and packages.

Click “Upgrade Main Firmware” under “Maintenance” in the side menu to bring out the information page.

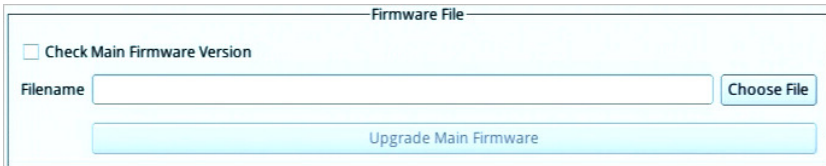
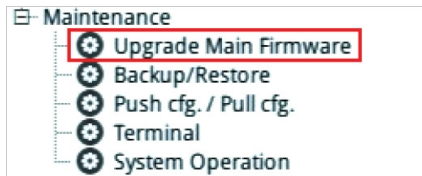
A screenshot of a web form titled "Firmware File". At the top left, there is a checkbox labeled "Check Main Firmware Version". Below it is a text input field labeled "Filename" with a "Choose File" button to its right. At the bottom of the form is a large, light blue button labeled "Upgrade Main Firmware".

To upgrade the main firmware:

1. Get the newest firmware by downloading the firmware from ATEN’s website to a computer.
2. Unzip the .zip file for the .csf file and transfer it to a USB flash drive.
Note: Please use FAT file system formatted USB flash drive(s).
3. Remove the USB flash drive from the computer and insert it to a USB port of the console station.
4. On the console station firmware page, click “Choose File” and a file management window will pop-up:

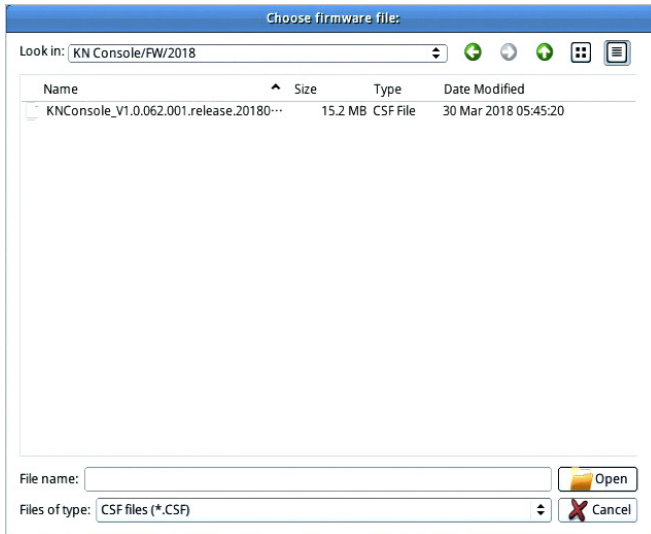

5. Navigate to the directory that the new firmware file is in, click to select the file and click “Open”.

The file will be displayed in the *Filename* field of the configuration page as shown below:

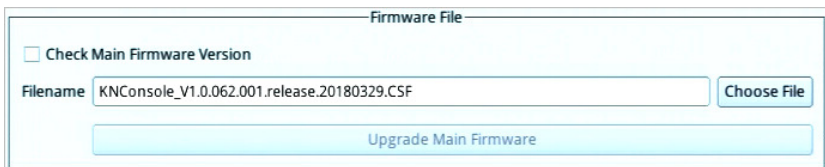

6. Click Upgrade Main Firmware to start the upgrade procedure.
 - ◆ If you enabled *Check Main Firmware Version* the current firmware level is compared with that of the upgrade file. If the current version is equal to or higher than the upgrade version, a popup message appears, to inform you of the situation and stops the upgrade procedure.
 - ◆ If you didn't enable *Check Main Firmware Version*, the upgrade file is installed without checking what its level is.
 - ◆ Upgrade progress information is shown in a *Progress* bar.
 - ◆ Once the upgrade completes successfully, the console station will restart.
7. Log in again and check if the firmware version is the newest one.

Note: To recover from a “failed upgrade” situation, see *Firmware Upgrade Recovery* on page 68.

Firmware Upgrade Recovery

Should the console station’s main firmware upgrade procedure fail, and the console station becomes unusable, follow the firmware upgrade recovery procedure below to recover the console station to its original firmware version:

1. Power off the console station by unplugging the power adapter.
2. Press and hold the Reset Switch in using a sharp object.
3. Download and save the firmware file you want to upgrade the console station with onto a USB flash drive, name it *firmware.csf*.
4. Plug the USB flash drive containing *firmware.csf* into the console device.
5. While holding the Reset Switch in, power up the console station by replugging the power adapter.

This upgrades the console station’s firmware using the firmware file saved on the USB drive.

Backup / Restore

Backup/Restore gives you the ability to back up the console station’s configuration and user profile information.

Click “Backup/Restore” under “Maintenance” in the side menu to bring out the information page.

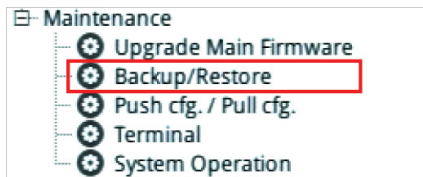

The image shows a software interface with two main sections: 'Backup' and 'Restore'.
The 'Backup' section contains a 'Password' text input field and a 'Backup' button.
The 'Restore' section contains a 'Filename' text input field with a 'Choose File' button, a 'Password' text input field, and three radio buttons: 'Select All' (selected), 'User Account/Devices', and 'User Select'.
Below the radio buttons is an 'Options' section with a list of checkboxes: 'Device Information', 'ANMS', 'User Account/Devices', 'Network', and 'Security'. All these checkboxes are checked.
At the bottom of the 'Restore' section is a 'Restore' button.

Backup

To backup the device's settings:

Note: A USB flash drive is required to be connected to the console station to store the backup file.

1. (Optional) In the *Password* field, key in a password for the file.

Note:

1. Setting a password is optional. If you do not set one, the file can be restored without specifying a password.
 2. If you do set a password, make a note of it, since you will need it to be able to restore the file.
2. Click "Backup". A file management window will pop-up as shown below:

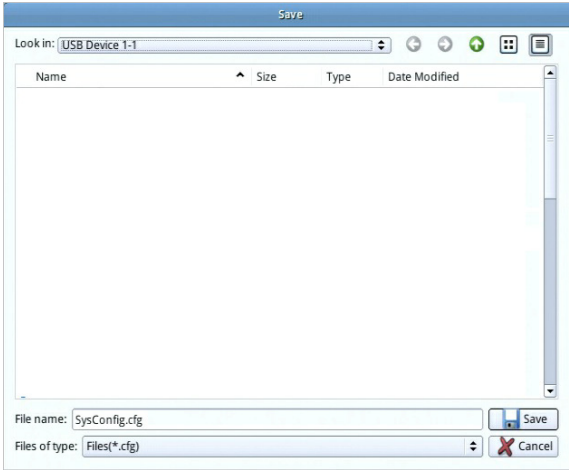

3. In the *File name* field, enter a backup file name and click “Save”.
The system will display a success message to indicate successful backup.

Restore

To restore a previously-saved settings:

Note: A USB flash drive with the previously backed-up file is required to be connected to the console station for backup file retrieval.

1. Click the “Choose File” button for the file management window:

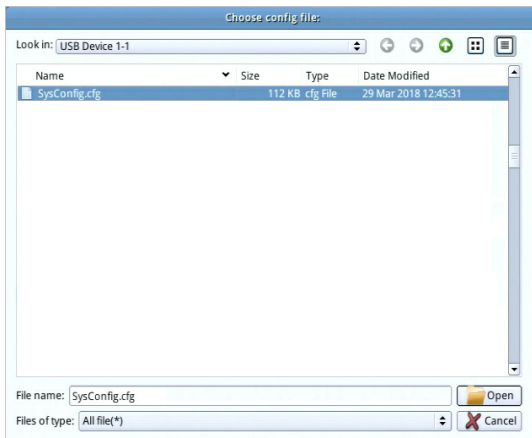

2. Where applicable, go to the directory with the backup file (.cfg), click to select the file (highlighted as shown above) and click “Open”.

3. If you set a password when you created the file, key it in the *Password* field.
4. Select as many of the options that are presented as you wish to restore.
5. Click “Restore”.

The system will display a success message to indicate the restoration was successful.

A “Your system will automatically restart in one minute” message will follow the success message above before the system restarts.

Push / Pull Configuration

Push / Pull Configuration gives you the ability to deploy or retrieve your settings to or from other console stations.

Click “Push cfg. / Pull cfg.” under “Maintenance” in the side menu to bring out the information page.

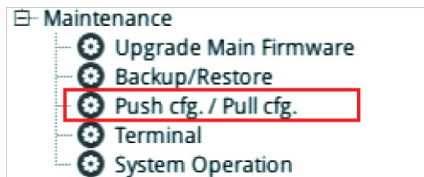

Push cfg. / Pull cfg.

Server List: (example:192.168.1.100:9000 or [2008:123:100:9000])

Username

Password

Options

Device Information

Network

ANMS

Security

User Account/Devices

Firmware

Pull Configuration

To pull (retrieve) a configuration to your console station:

1. Enter the device's IP address or IPv6 Address you wish to retrieve the configuration from.

Alternatively, you can mouse over the magnifying glass to find a list of the devices on the same LAN and click the device's IP or IPv6 address:

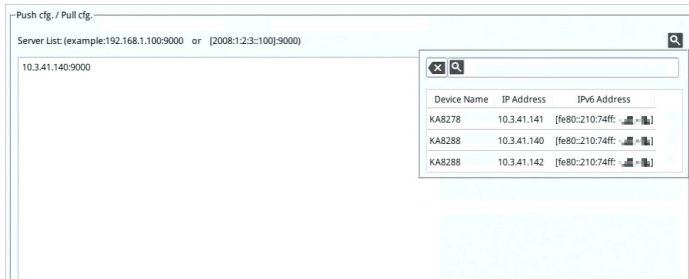

2. Enter the administrative username and password of the selected device.
3. Select the information you would like to retrieve to your console station by checking the checkbox(es).

Note: Firmware files cannot be retrieved. If you check the Firmware checkbox, the **Pull** button will not be available.

4. Click **Pull** to retrieve the information.

The console station will restart after successfully retrieving the information.

Push Configuration

To push (deploy) a configuration from your console station:

Note: You can deploy the configuration / FW to multiple devices using one procedure (shown below) instead of one procedure for every device.

1. Enter the device's IP address(es) or IPv6 Address(es) you wish to deploy the configuration to.

Alternatively, you can mouse over the magnifying glass to find a list of the devices on the same LAN and click the device's IP or IPv6 address:



2. Enter the administrative username and password of the selected device(s).
3. Select the information you would like to deploy from your console station by checking the checkbox(es).

Note: If you checked the Firmware checkbox, please remember to click the **Choose** button to select a firmware from a USB flash drive.

4. Click **Push** to deploy the information.

The console station(s) will restart after successfully receiving the deployment information.

Terminal

Terminal provides a command line to execute options using a terminal interface. Type a command in the window and hit [Enter] to execute it.

Click "Terminal" under "Maintenance" in the side menu to bring out the terminal page.

Note: Expand the submenu by clicking the + symbol if "Terminal" is not shown.

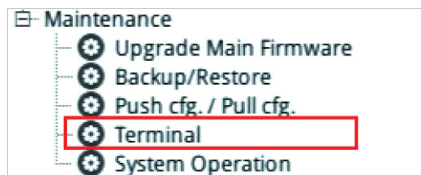

Available commands include:

- ◆ GET => Gets current configuration.
- ◆ HELP => Provides Help information for commands.
- ◆ CLEAR => Clears the screen.
- ◆ PING => Displays ping host information.
- ◆ SETLDAPMEMBER => Sets new value for ldap member.
- ◆ SETLDAPMEMBEROF => Sets new value for ldap memberof.
- ◆ SETPROMPT => Sets prompt string.
- ◆ TRACERT => Displays trace route information.
- ◆ DEVICEHISTORY => Clear/Enable/Disable device list history
- ◆ SELFDIAGNOSTIC => Self Diagnostic
- ◆ SETMOUSEACC => Check if mouse acceleration is enabled or not
- ◆ SETMOUSEACC 1 / 0 => Enable / disable mouse acceleration
- ◆ DISABLEAUDIO 0 / 1 => Enable / disable audio

Note: 1. For support and use of CM1284, mouse acceleration must be disabled.

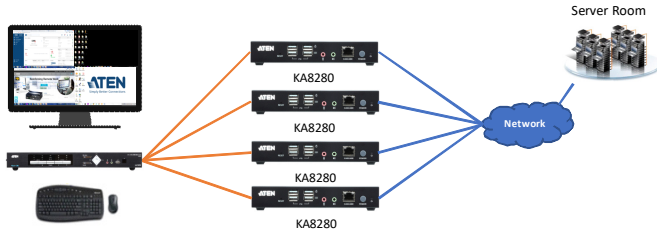

2. When not using CM1284, mouse acceleration should be enabled.

System Operation

The System Operation page lets you restore certain configuration changes that were made to the KVM over IP console station back to their original factory default values.

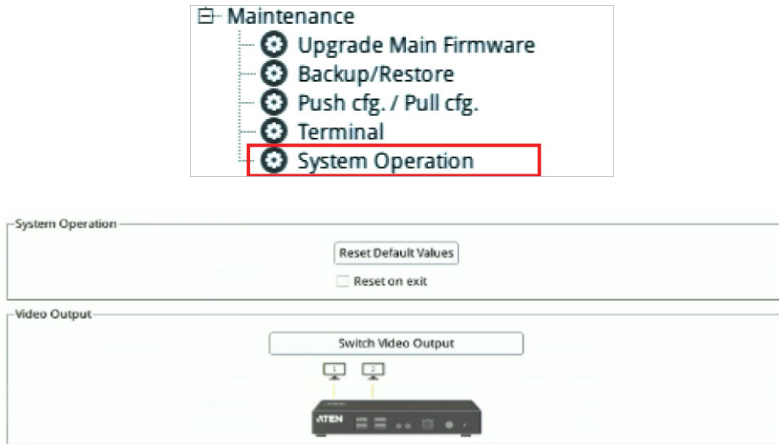

Reset Default Values

Clicking this button undoes all Customization page changes that have been made to the KVM over IP console station and returns the parameters to the original factory default settings.

The system will ask for confirmation:

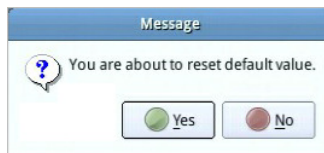

Click **Yes** to go ahead. The system will restart after the reset.

Click **No** to cancel operation.

Reset on exit:

If you checked the checkbox, the system will ask if you would like to reset the KVM over IP console station (and implement all the new settings) upon exiting the System Configuration page.



Click **Yes** to go ahead with the reset (the system will also reboot).

Click **No** if you do not want the system to be reset.

If you change the console station's IP Address (see *Network* on page 55), the checkbox is automatically checked and the console station will reset when you exit the page.

If you clear the check mark before exiting the page, the changed IP settings will be ignored and the original IP address settings will remain in effect.

Note: Even though the changed IP settings are ignored, they still remain in the network settings fields. Which means that the next time you open this page the *Reset on exit* checkbox will automatically be enabled, and when the console station resets, the new IP settings that you thought you discarded will become the ones used by the console station. To avoid this problem, you should go back to the network settings page and be sure that the IP settings that appear in the fields are the ones you want to use.

Switch Video Output

Clicking this button to switch the video output for KA8278 / KA8288 only. To be able to use Switch Video Output, both display ports are required to connect to a display.

Quick User Configuration

The user icon allows quick access to password change, configure preferences, logout, restart the system, shut down the system, or display quick information about the console station.



Click the User icon for its menu:

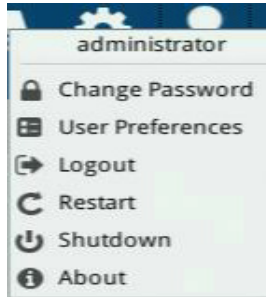

Option	Description
Change Password	Click this option to change the password of the current user.
User Preferences	Select the preferred language from the scroll menu. Language change will be shown immediately. Logout Timeout is the idle time period (no actions) where the system automatically logs you out. Set a logout timeout time in minutes. Enter 0 if you do not want the system to log you out from idling.
Logout	Click this option to log out of the system.
Restart	Click this option to restart the system.
Shutdown	Click this option to safely shut down the system. This is recommended way to shut down the system. Pull the power adapter after the system display a safe-to-shutdown message.
About	Click this option to display the KVM over IP console station's device name, firmware version, IP address, and IPv6 address

This Page Intentionally Left Blank

Chapter 6

Toolbar Interface

Overview

The KVM over IP console station's interface provides a toolbar to help you with the remote control operations on the captured port. The toolbar is usually hidden.



To bring up the toolbar, locate a down arrow symbol as shown:



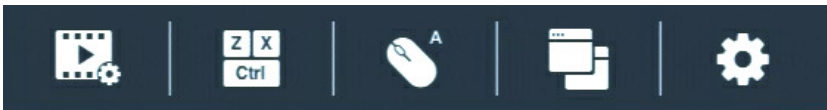

Mouse over the down arrow symbol to bring up the toolbar.



The meanings of the toolbar icons are explained in the table below:

Icon	Purpose
	<u>Video icon</u> This icon brings up the video settings. Please see <i>Video Settings</i> on page 81 for more details.
	<u>Macros icon</u> This icon provides access to three functions found in the Macros dialog box: Hotkeys, User Macros, and System macros. Please see <i>Macros</i> on page 83 for more details.

Icon	Purpose
	<p><u>Mouse Sync Mode icon</u></p> <p>This provides automatic locked-in syncing of the remote and local mouse pointers – eliminating the need to constantly resync the two movements.</p> <p>Click the icon to toggle between <i>Auto Mouse Sync Mode</i> (mouse icon with an A) and <i>Manual Mouse Sync Mode</i> (mouse icon with an M).</p> <p>Please see <i>Mouse Sync Mode</i> on page 95 for more details.</p>
	<p><u>Connect icon</u></p> <p>Click for a list of available ports. Click to select the port you wish to connect to.</p>
	<p><u>Configuration icon</u></p> <p>Click for further configurations.</p> <p>Please see <i>Further Configuration</i> on page 90.</p>

Exit Remote Location

There are two ways to exit from the remote control operations on the captured port.

1. Click *Back*

On the toolbar interface, click the “Configuration icon” for more operation options. Click **Back** to exit remote location.

2. Use Macros

By default, pressing the “Exit Remote Location” hot keys (F2, F3, F4) will also exit remote location.

Note: Use the updated hot keys should there be a change to this function’s hot key.

Video Settings

Click the *Video* icon on the toolbar to bring up the *Video Settings* dialog box. The options in the basic dialog box allow you to adjust the Screen Position, set Auto Sync, slide-to-adjust Performance bar setting, Enhanced Text Mode, slide-to-adjust Video Quality bar, and Set to Grayscale.

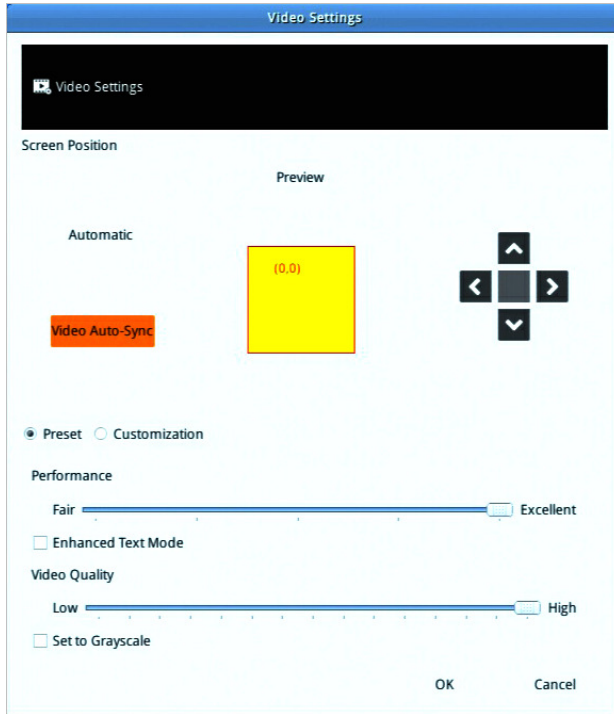

The meanings of the video adjustment options are given in the table below:

Options	Description / Operation
Screen Position	Adjust the horizontal and vertical position of the remote server window by clicking the Arrow buttons.

Options	Description / Operation
Video Auto-Sync	<p>Click Video Auto Sync to have the vertical and horizontal offset values of the remote screen detected and automatically synchronized with the local screen.</p> <p>Note:</p> <ol style="list-style-type: none">1. If the local and console station mouse pointers are out of sync, in most cases, performing this function will bring them back into sync.2. This function works best with a bright screen.3. If you are not satisfied with the results, use the Screen Position arrows (on the right) to position the remote display manually.
Preset / Customization	<p>Using the Preset and Custom buttons allow you to set and save custom video settings, and revert back to default video settings.</p>
Performance	<p>Use the slide bar to select the type of Internet connection that the console station uses. Dragging the performance bar will also automatically adjust the <i>Video Quality</i> settings to optimize the quality of the video display.</p> <p>Since network conditions vary, if none of the preset choices seem to work well, you can use the Video Quality slide bar to adjust the settings to suit your conditions.</p>
Enhanced Text Mode	<p>Check to enhance color and video quality, especially for texts.</p>
Video Quality	<p>Drag the slider bar to adjust the overall Video Quality. The larger the value, the clearer the picture and the more video data goes through the network. Depending on the network bandwidth, a high value may adversely effect response time.</p>
Set to Grayscale	<p>Check to set video display to grayscale.</p>

Macros

The Macros icon provides access to three functions found in the Macros dialog box: Hotkeys, User Macros, and System Macros. Each of these functions is described in the following sections.

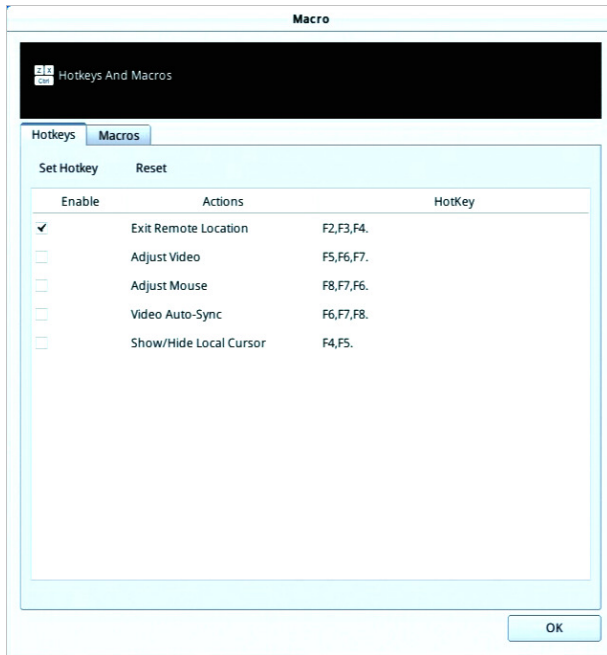

Hotkeys

Various actions related to manipulating the remote server can be accomplished with hotkeys. The *Hotkey Setup* utility (accessed by clicking this icon), lets you configure which hotkeys perform the actions.

Each action in the Actions column corresponds to the hot keys in the HotKey column on the same row. Check the checkbox in the Enable column on the same row to enable its hotkey.

To change the hotkey for an action:

1. If you are not in the “Hotkeys” tab, click to select to go into the Hotkeys page.
2. Highlight the *Action* and click **Set Hotkey** for the window dialog below:

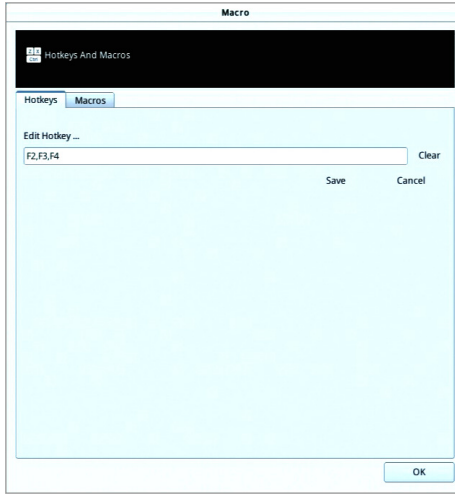

3. Press your selected Function keys (one at a time). The key names will appear in the *Hotkeys* field as you press them.
 - ◆ You can use the same function keys for more than one action, as long as the key sequence is not the same.
 - ◆ To cancel setting a hotkey value, click **Cancel**; to clear an action's Hotkeys field, click **Clear**.
4. When you have finished keying in your sequence, click **Save**.

To reset all the hotkeys to their default values, click **Reset**.

An explanation of the Hotkey actions is given in the table below:

Action	Explanation
Exit Remote Location	Breaks the connection to the KVM over IP console station and returns you to console station operation. This is equivalent to clicking the <i>Back</i> option under the Configuration icon of the toolbar. The default keys are F2, F3, F4.
Adjust Video	Brings up the <i>Video Settings</i> dialog box. This is equivalent to clicking the <i>Video Settings</i> icon on the console station toolbar. The default keys are F5, F6, F7.
Adjust Mouse	This synchronizes the local and remote mouse movements. The default keys are F8,F7,F6.
Video Auto-Sync	This combination performs an auto-sync operation. It is equivalent to clicking the <i>Video Auto Sync</i> button in the <i>Video Settings</i> dialog box. The default keys are F6,F7,F8.

Action	Explanation
Show / Hide Local Cursor	Toggles off and on: hides local cursor and locks the mouse pointer and keyboard use within the Windows/Java Client AP window, plus hides the control panel. This is equivalent to selecting the <i>Single</i> pointer type from the <i>Mouse Pointer</i> option under the Configuration icon of the toolbar. The default keys are F4,F5.

User Macros

User Macros are created to perform specific actions on the remote server. To create a macro, do the following:

1. If you are not in the “Macros” tab, click to select to go into the Macros page.

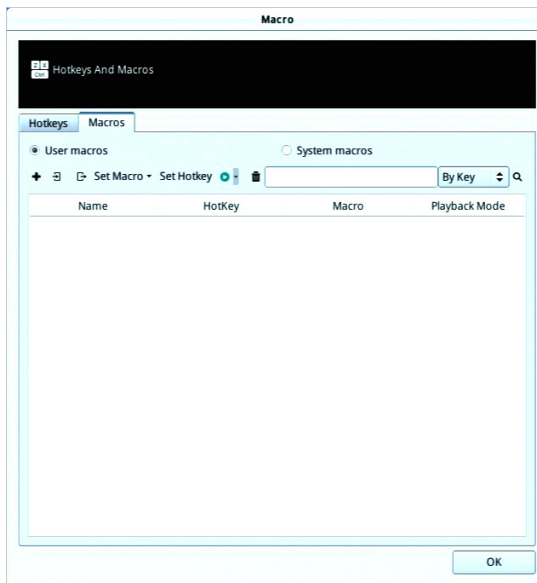

2. Select *User Macros* and click the + symbol.

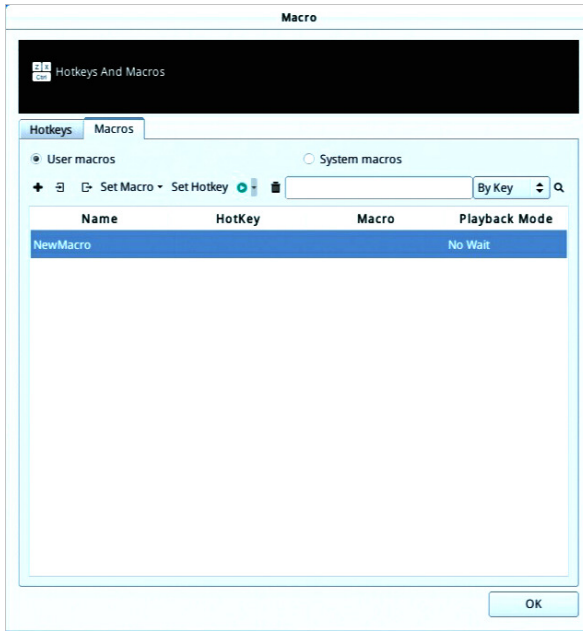

3. In the dialog box, you can choose to replace the “New Macro” text with a name of your choice for the macro.
4. Click **Set Macro** followed by **Record**.

The dialog box disappears as a small panel appears at the top left of the screen:

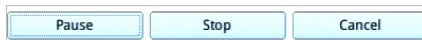

5. Press the keys for the macro.
 - ◆ To pause macro recording, click **Pause**. To resume, click **Pause** again.
 - ◆ Clicking **Cancel** cancels all keystrokes.

Note:

1. Case is not considered – typing **A** or **a** has the same effect.
2. Only the default keyboard characters may be used. Alternate characters cannot be used. For example, if the keyboard is Traditional Chinese and default character is **A** the alternate Chinese character obtained via keyboard switching is not recorded.

- When finished, click **Stop**. You will return to the Macros dialog box with your macro key presses displayed in the Macro column:

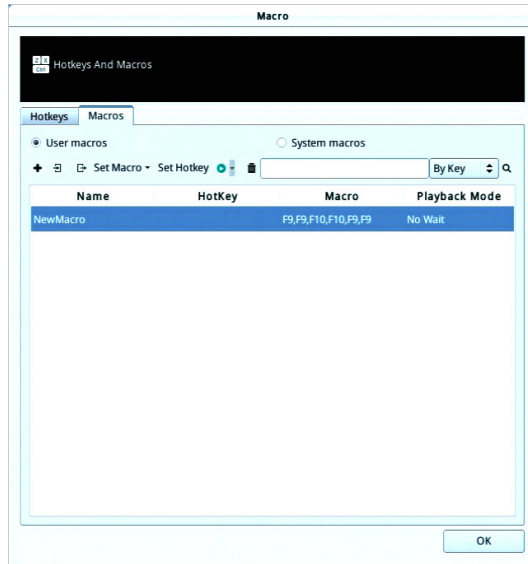

- If you want to change any of the keystrokes, select the macro, click **Set Macro** followed by **Edit**. This brings up a dialog box. You can change the content of your keystrokes, change their order, etc.

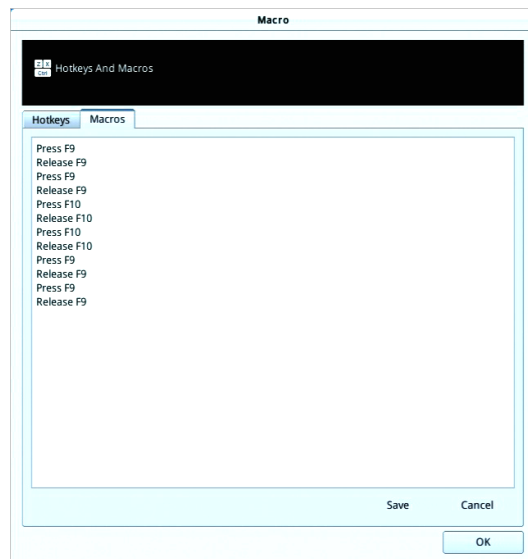

8. Click **Save** to save the changes, or click **Cancel** to cancel the changes. Both option will return you to the Macros dialog box.
9. Repeat the procedure for any other macros you wish to create.

After creating your macros, you can run them in any of three ways:

1. By using the hotkey (if one was assigned).
2. By playing it in this dialog box.

If you run the macro from this dialog box, you have the option of specifying how the macro runs. Click the down arrow symbol to select your option.

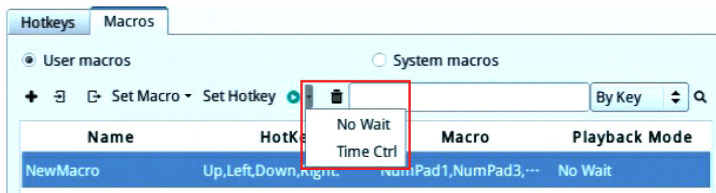



- ◆ *No Wait*: The macro runs the key presses one after another with no time delay between them.
- ◆ *Time Ctrl* (time control): The macro waits for the amount of time between key presses that you took when you created it.
- ◆ If you click the **Play** symbol without selecting an option, the macro runs with the default choice (*No Wait* or *Time Ctrl*), which is shown in the *Playback Mode* column.

You can change the default choice by clicking on the current choice (*No Wait* in the screenshot above), and selecting the alternate choice.

Import / Export Macros

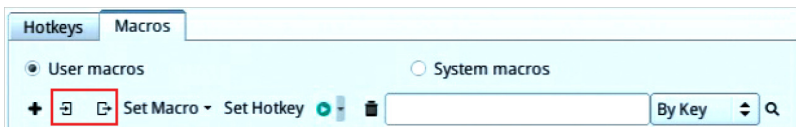
The import / export function allows you to import or export macros from or to a USB flash drive.



- ◆ Click the import symbol  to search through the USB flash drive to import the macros.
- ◆ Click the export symbol  and enter a name to save the macros to the USB flash drive.

Delete Macros

To delete a macro, click to select the macro and click the trash can symbol to delete a macro.

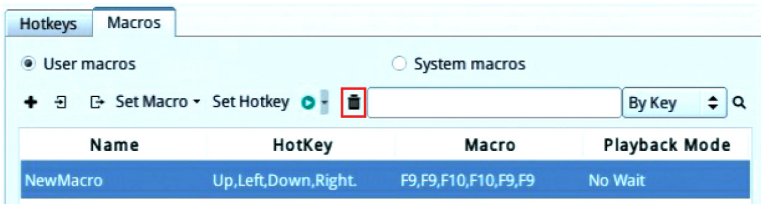

Search Macros

The search function (on the top right-hand side of the dialog box) lets you filter the list of macros that appear in the list. Click the drop-down arrow (next to the magnifying glass icon) to choose whether you want to search by name or by key; enter a string in the search field for the search; then click the **Search** symbol (magnifying glass symbol). All instances that match your search string appear in the list.

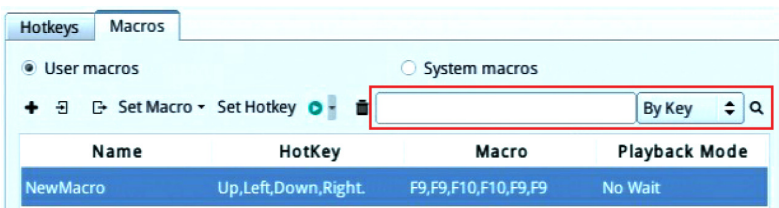

System Macros

System Macros are used to create exit macros for when you close a session. For example, as an added measure of security, you could create a macro that sends the Winkey-L combination which would cause the remote server's login page to come up the next time the device was accessed.

Ways to create, delete or search for macros are the same as *User Macros*, please refer to *User Macros* on page 85. System macros cannot be imported or exported.

For more information on system macros for different KVM over IP switches, please refer to their user manuals.

Further Configuration

More configuration options are available when clicking the configuration icon:

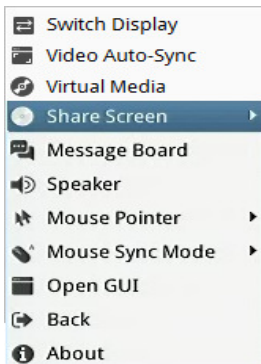

Options	Description
Switch Display	<p>When you have a dual-display model (KA8278 or KA8288) and have both displays connected, this option will appear to allow you to switch between the two displays.</p> <hr/> <p>Note: This function will not work when Boundless Switching with Cascade is enabled.</p>
Video Auto-Sync	<p>Click to perform a video and mouse autosync operation. It is the same as clicking the Auto Sync button in the <i>Video Options</i> dialog box (see <i>Video Settings</i> on page 81).</p>
Virtual Media	<p>Click to bring up the <i>Virtual Media</i> dialog box. See <i>Virtual Media</i> on page 91 for specific details.</p> <p>Note: This icon displays in gray when the function is disabled or not available.</p>
Share Screen	<p>When there are multiple console stations connected within the network, you can share your current screen contents to another console station by selecting it under Share Screen.</p> <p>Note: When shared, the console station receiving the shared contents is granted the same access and operation privileges as you, which will be lost when he closes or switches to another port.</p>

Options	Description
Message Board	Click to bring up the Message Board (see <i>Message Board</i> on page 93).
Speaker	Click to toggle sound from the remote server to be heard on the client computer's speakers on or off. The option is grayed out when the speaker is toggled Off. The KA8278 / KA8288 only allows either one of the connected source to transmit sound.
Mouse Pointer	Mouse over the option and click to select the mouse pointer type. Note: In the main GUI page, only Dual and Crosshairs are available. In a port page, three pointers are available.
Mouse Sync Mode	Mouse over the option and click to select the mouse sync mode. Please see <i>Mouse Sync Mode</i> on page 95.
Open GUI	Click to open the GUI of the connected KVM over IP switch. Please refer to the user manual of the connected KVM over IP switch for more details.
Back	Click to return to the page on the KVM over IP Console Station that brought you here.
About	Click to get information about this connection. The information include Device Name, IP Address, Current Port, Video Mode and Channel / User Numbers.

Virtual Media

The *Virtual Media* feature allows a USB removable disk or a smart card reader on a user's system to appear and act as if it were installed on the remote server.

Note: ISO files of FAT 16/32 format saved on the inserted USB are also supported to be used on the remote servers.

To mount a virtual media device:

1. Click the Virtual Media icon to bring up the *Virtual Media* dialog box:

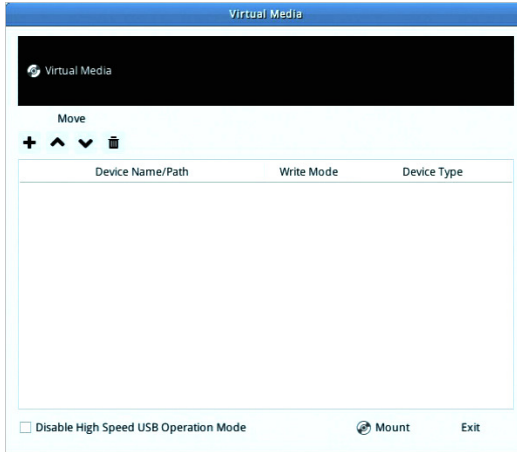

2. Click the + symbol and select the media source.

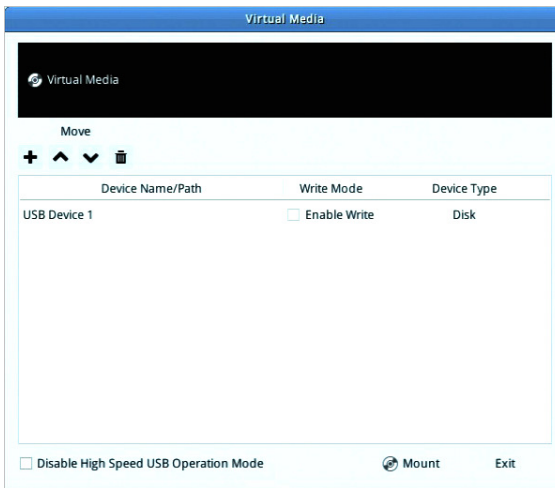

3. If your device only supports full speed USB, check the *Disable High Speed USB Operation Mode* checkbox.
4. To add additional media sources, click the + symbol, and select the source as many times as you require. Up to two virtual media choices can be mounted. The top three in the list are the ones that are selected. Virtual Media and Smart Card readers can be mounted at the same time. To rearrange the selection order, highlight the device you want to move, then click the Up or Down Arrow button to promote or demote it in the list.

5. *Read* refers to the redirected device being able to send data to the remote server; *Write* refers to the redirected device being able to have data from the remote server written to it. For the redirected device to be writable as well as readable, click to put a check in the *Enable Write* checkbox:

Note: If a redirected device cannot be written to, it appears in gray.

6. To remove an entry from the list, select it and click the trash can icon.
7. After you have made your media source selections, click **Mount**. The dialog box closes. The virtual media devices that you have selected are redirected to the remote server, where they show up as drives on the remote server's file system.

Once mounted, you can treat the virtual media as if they really existed on the remote server – drag and drop files to/from them; open files on the remote server for editing and save them to the redirected media, etc.

8. To end the redirection, bring up the *Control Panel* and click on the Virtual Media icon. All mounted devices are automatically unmounted.



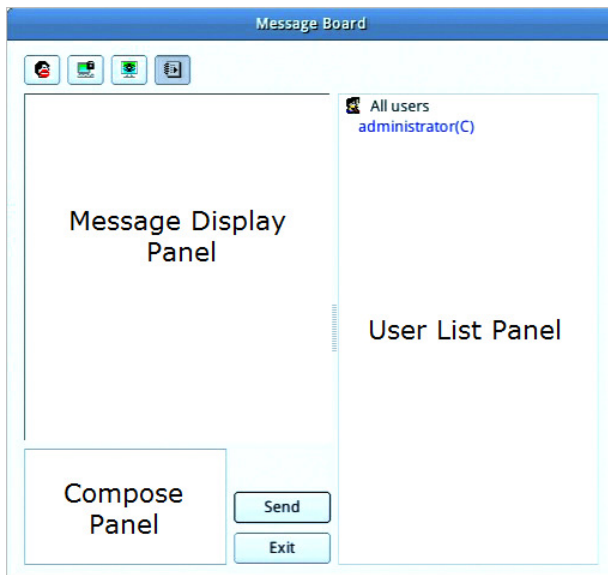

Message Board

The KVM over IP console station supports multiple user logins, which may cause access conflicts. To alleviate the problem, a message board has been provided, which allows users to communicate with each other.



Buttons

The buttons in the dialogue box toggles actions and are described in the table below:

Button	Action
	Enable/Disable Chat. When disabled, messages posted to the board are not displayed. The button is shadowed when Chat is disabled. The icon displays next to the user's name in the User List panel when the user has disabled Chat.
	Occupy/Release Keyboard/Video/Mouse. When you Occupy the KVM, other users cannot see the video, and cannot input keyboard or mouse data. The button is shadowed when the KVM is occupied. The icon displays next to the user's name in the User List panel when the user has occupied the KVM.
	Occupy/Release Keyboard/Mouse. When you Occupy the KM, other users can see the video, but cannot input keyboard or mouse data. The button is shadowed when the KM is occupied. The icon displays next to the user's name in the User List panel when the user has occupied the KM.
	Show/Hide User List. When you Hide the User List, the User List panel closes. The button is shadowed when the User List is open.

Message Display Panel

Messages that users post to the board - as well as system messages - display in this panel. If you disable Chat, however, messages that get posted to the board will not appear.

Compose Panel

Key in the messages that you want to post to the board in this panel. Click **Send** to post the message to the board.

User List Panel

The names of all the logged in users are listed in this panel.

- ◆ Your name appears in blue; other users' names appear in black.
- ◆ By default, messages are posted to all users. To post a message to one individual user, select the user's name before sending your message.
- ◆ If a user's name is selected, and you want to post a message to all users, select All Users before sending your message.

- ◆ If a user has disabled Chat, the disable chat icon will be displayed on the left of user's name.
- ◆ If a user has occupied the KVM or the KM, the corresponding icon will be displayed on the left of the user's name.

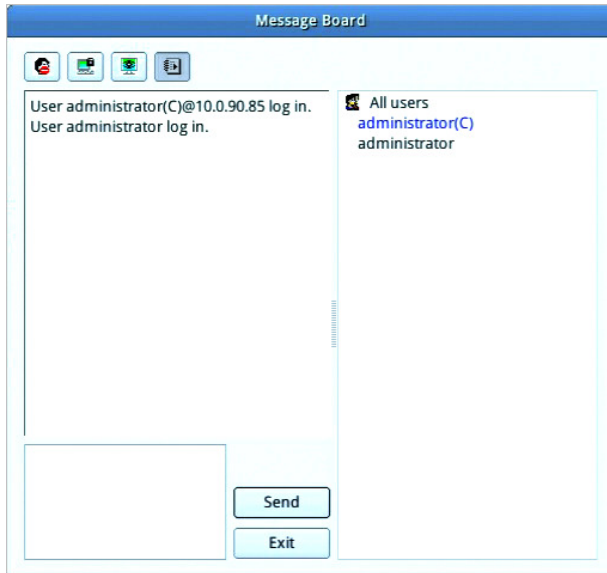

Mouse Sync Mode

Synchronization of the local and remote mouse pointers is accomplished either automatically or manually.

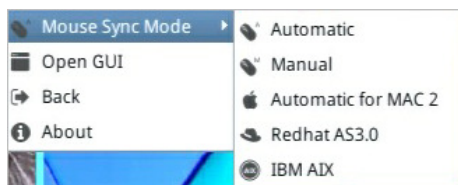

Automatic Mouse Synchronization

This provides automatic locked-in syncing of the remote and local mouse pointers – eliminating the need to constantly resync the two movements.

Manual Mouse Synchronization

If the local mouse pointer goes out of sync with the remote system's mouse pointer there are a number of methods to bring them back into sync:

1. Perform an *Auto Sync* with the Video Adjustment function (see *Video Settings*, page 79, for details).
2. Invoke the *Adjust Mouse* function with the *Adjust Mouse* hotkeys (see *Adjust Mouse* on page 84 for details).
3. Set the mouse speed and acceleration for each problematic server attached to the switch. See the user manual of the corresponding KVM over IP switch for instructions.

Mac and Linux Considerations

- ◆ For Mac OS versions 10.4.11 and higher, there is a second Sync setting to choose from. If the default Mouse Sync result is not satisfactory, try the **Mac 2** setting. To select Mac 2, click the *Further Configuration* icon, mouse over *Mouse Sync Mode* → *Automatic for Mac 2*:
- ◆ Linux does not support Sync Mode, but there is a setting on the Mouse Sync Mode menu for Redhat AS3.0 systems. If you are using a USB Adapter Cable, with an AS3.0 system and the default mouse synchronization is not satisfactory, you can try the Redhat AS3.0 setting. In either case, you must perform the manual mouse synchronization procedures described above.

Safety Instructions

General

- ◆ This product is for indoor use only.
- ◆ Read all of these instructions. Save them for future reference.
- ◆ Follow all warnings and instructions marked on the device.
- ◆ Do not place the device on any unstable surface (cart, stand, table, etc.). If the device falls, serious damage will result.
- ◆ Do not use the device near water.
- ◆ Do not place the device near, or over, radiators or heat registers.
- ◆ The device cabinet is provided with slots and openings to allow for adequate ventilation. To ensure reliable operation, and to protect against overheating, these openings must never be blocked or covered.
- ◆ The device should never be placed on a soft surface (bed, sofa, rug, etc.) as this will block its ventilation openings. Likewise, the device should not be placed in a built in enclosure unless adequate ventilation has been provided.
- ◆ Never spill liquid of any kind on the device.
- ◆ Avoid circuit overloads. Before connecting equipment to a circuit, know the power supply's limit and never exceed it. Always review the electrical specifications of a circuit to ensure that you are not creating a dangerous condition or that one doesn't already exist. Circuit overloads can cause a fire and destroy equipment.
- ◆ Unplug the device from the wall outlet before cleaning. Do not use liquid or aerosol cleaners. Use a damp cloth for cleaning.
- ◆ The device should be operated from the type of power source indicated on the marking label. If you are not sure of the type of power available, consult your dealer or local power company.
- ◆ To prevent damage to your installation it is important that all devices are properly grounded.
- ◆ Do not allow anything to rest on the power cord or cables. Route the power cord and cables so that they cannot be stepped on or tripped over.
- ◆ Position system cables and power cables carefully; Be sure that nothing rests on any cables.

- ◆ When connecting or disconnecting power to hot-pluggable power supplies, observe the following guidelines:
 - ◆ Install the power supply before connecting the power cable to the power supply.
 - ◆ Unplug the power cable before removing the power supply.
 - ◆ If the system has multiple sources of power, disconnect power from the system by unplugging all power cables from the power supplies.
- ◆ Never push objects of any kind into or through cabinet slots. They may touch dangerous voltage points or short out parts resulting in a risk of fire or electrical shock.
- ◆ Do not attempt to service the device yourself. Refer all servicing to qualified service personnel.
- ◆ If the following conditions occur, unplug the device from the wall outlet and bring it to qualified service personnel for repair.
 - ◆ The power cord or plug has become damaged or frayed.
 - ◆ Liquid has been spilled into the device.
 - ◆ The device has been exposed to rain or water.
 - ◆ The device has been dropped, or the cabinet has been damaged.
 - ◆ The device exhibits a distinct change in performance, indicating a need for service.
 - ◆ The device does not operate normally when the operating instructions are followed.
- ◆ Only adjust those controls that are covered in the operating instructions. Improper adjustment of other controls may result in damage that will require extensive work by a qualified technician to repair.
- ◆ Additional protection to secure and fix the equipment is needed if the equipment is installed by stacking; by locking it to the rack, screwing it to the frame, or other similar methods.
- ◆ Keep the Cat 5e/6 cable as far away as possible from potential sources of EMI, such as electrical cables, transformers, and light fixtures. Do not tie the cables to electrical conduits or lay the cables on electrical fixtures.

Rack Mounting

- ◆ Before working on the rack, make sure that the stabilizers are secured to the rack, extended to the floor, and that the full weight of the rack rests on the floor. Install front and side stabilizers on a single rack or front stabilizers for joined multiple racks before working on the rack.

- ◆ Always load the rack from the bottom up, and load the heaviest item in the rack first.
- ◆ Make sure that the rack is level and stable before extending a device from the rack.
- ◆ Use caution when pressing the device rail release latches and sliding a device into or out of a rack; the slide rails can pinch your fingers.
- ◆ After a device is inserted into the rack, carefully extend the rail into a locking position, and then slide the device into the rack.
- ◆ Do not overload the AC supply branch circuit that provides power to the rack. The total rack load should not exceed 80 percent of the branch circuit rating.
- ◆ Make sure that all equipment used on the rack – including power strips and other electrical connectors – is properly grounded.
- ◆ Ensure that proper airflow is provided to devices in the rack.
- ◆ Ensure that the operating ambient temperature of the rack environment does not exceed the maximum ambient temperature specified for the equipment by the manufacturer
- ◆ Do not step on or stand on any device when servicing other devices in a rack.

Technical Support

International

- ◆ For online technical support – including troubleshooting, documentation, and software updates: **<http://eservice.aten.com>**
- ◆ For telephone support, see *Telephone Support* on page iv.

North America

Email Support		support@aten-usa.com
Online Technical Support	Troubleshooting Documentation Software Updates	http://eservice.aten.com
Telephone Support		1-888-999-ATEN ext 4988 1-949-428-1111

When you contact us, please have the following information ready beforehand:

- ◆ Product model number, serial number, and date of purchase.
- ◆ Your computer configuration, including operating system, revision level, expansion cards, and software.
- ◆ Any error messages displayed at the time the error occurred.
- ◆ The sequence of operations that led up to the error.
- ◆ Any other information you feel may be of help.

Specifications

Function	KA8270	KA8278	KA8280	KA8288
Connectors				
Video	1 x HDB-15 Female	1 x HDB-15 Female 1 x HDMI Female	1 x HDMI Female	2 x HDMI Female
RS-232	1 x DB-9 Male			
Power	1 x DC Jack			
Audio	2 x Audio Jack Female			
LAN Ports	1 x RJ-45 Female			
Keyboard	1 x USB Type-A Female			
Mouse	1 x USB Type-A Female			
USB Port	2 x USB Type-A Female			
Cascade Port	1 x RJ-45 Female			
LEDs				
Power	1 (Blue)			
Switches				
Power	1 x Pushbutton			
Reset	1 x Semi-recessed Pushbutton			
Video	1920 x 1200 @ 60 Hz			
Power Consumption	DC5V:4.66W:47.44 BTU/h	DC5V:6.53W:56.18 BTU/h	DC5V:4.66W:47.44 BTU/h	DC5V:6.53W:56.18 BTU/h
	Note: <ul style="list-style-type: none"> ◆ The measurement in Watts indicates the typical power consumption of the device with no external loading. ◆ The measurement in BTU/h indicates the power consumption of the device when it is fully loaded. 			
Environmental				
Operating Temperature	0 - 40 °C			
Storage Temperature	-20 - 60 °C			
Humidity	0 - 80% RH, Non-condensing			
Physical Properties				
Housing	Metal			
Weight	0.75 kg (1.65 lb)	0.8 kg (1.76 lb)	0.75 kg (1.65 lb)	0.8 kg (1.76 lb)

Function	KA8270	KA8278	KA8280	KA8288
Dimensions (L x W x H)	17.42 x 15.54 x 2.88 cm (6.86 x 6.12 x 1.13 in)	17.42 x 15.54 x 2.88 cm (6.86 x 6.12 x 1.13)	17.42 x 15.54 x 2.88 cm (6.86 x 6.12 x 1.13)	17.42 x 15.54 x 2.88 cm (6.86 x 6.12 x 1.13)

Troubleshooting

General Operation

Problem	Resolution
I have been given an account but I am unable to log in.	<ul style="list-style-type: none"> ◆ Make sure that you have correctly specified your Username and Password. ◆ Make sure that the administrator has given you the necessary permission to access the console station.
Sudden loss of network connection.	Close your connection to the KVM over IP console station. Wait approximately 30 seconds, and log in again.
The display on the client computer is distorted and performing an Autosync doesn't resolve the problem.	<p>Switch ports to a port with a different resolution, then switch back.</p> <p>If the above didn't resolve the problem, change the resolution and refresh rate for the system running on the port. Afterward, you can either run at the new resolution, or switch back to the original resolution.</p>
My ATEN over IP unit is not listed in the Device List of IP Installer.	<ul style="list-style-type: none"> ◆ Make sure the Broadcast function is enabled from your switch or router in order for the auto-discover to work properly. ◆ Make sure to turn off your firewall and/or antivirus software temporarily in order for the audio-discover to work properly. ◆ Make sure the ATEN over IP unit and the PC are under same network segment.
Sudden restart / reboot of my ATEN over IP unit.	<p>Recall if you have done any of the following and refrain from doing such.</p> <ul style="list-style-type: none"> ◆ Repeatedly clicking multiple functions and switching between various ports within a short period of time (~< 2 minutes). ◆ Attempting to operate the unit in the middle of saving system settings and/or firmware upgrade.

Mouse Problems

Problem	Resolution
Mouse and/or Keyboard not responding.	Unplug the cable(s) from the console port(s), then plug it/ them back in.
Mouse movement extremely slow	There is too much data being transferred for your connection to keep up with. Lower the video quality (<i>Video Settings</i> on page 81) so that less video data is transmitted.
There are two mouse pointers after the remote server is accessed.	You can select another pointer type. See <i>Mouse Pointer</i> on page 91.
Why is there a Dual Pointer mode?	When you are not in Mouse Sync Mode, you need the two pointers so that you know the remote server pointer is actually at the location you think it is at. Otherwise, you might perform a mouse operation and, because of net lag, the remote server pointer may not be at the location that your client computer pointer is at.
Mouse pointer confusion	If you find the display of two mouse pointers (local and remote) to be confusing or annoying, you can use the <i>Toggle Mouse Display</i> function to shrink the non-functioning pointer. See <i>Mouse Pointer</i> on page 91.

Virtual Media

Problem	Resolution
Virtual Media doesn't work.	The remote server's mainboard does not support USB. If there is a newer firmware and BIOS version for the remote server's mainboard – one that supports USB – get it from the manufacturer and upgrade the server's mainboard firmware and BIOS.

Panel Array Mode

Problem	Resolution
Low resolution video – the screens don't display clearly.	This sometimes occurs due to the screens being scaled to fit in the panels. Decrease the number of panels that are displayed.

Supported KVM Switches

Please visit our official web site for the fully supported KVM over IP switches that the console station is able to remotely access, monitor, and control.

Note: The aforementioned KVM over IP switches require firmware version v1.6.151 or above to support the KVM over IP Console Station.

Remote Access/Monitor Restriction

When adding remote access/monitor on the KA8270 / KA8278 / KA8280 / KA8288, the number of ports available for remote is restricted by how many buses the KVM over IP switch supports.

To distinguish the supported buses from the KVM over IP switch, please refer to the first digit of the model number. For example, if the KVM over IP switch that you are using is KN8164V, 8 is the number of remote buses supported.

Remote Access

For example, 8 is the number of remote buses KN8164V supports. A warning message “Not available” appears when accessing the KN8164V from the console station as 8 remote buses are occupied.

Remote Monitor

A warning message “Not available” appears on each panel in the panel array mode when 8 remote buses of KN8164V are occupied.

Optional Rack Mounting

VE-RMK1U

Other than the standard rack mounting and wall mounting, the VE-RMK1U is also available for KA8270 / KA8278 / KA8280 / KA8288. Please refer to the *VE-RMK1U* user manual for details.

Session Usage When Working with KG Series

The KG series simultaneously shares 16/32 independent connections to the attached servers (KG0016 / KG0032). The supported sever and session usage varies when working with the KA82 series depending on how many display and function that is used, please see the comparison table below.

Display 1	Display 2	Session Usage
Panel Array	Port View	2 (include 1 session usage from KA82 series to KG series)
Port View	Port View	3 (include 1 session usage from KA82 series to KG series)
Device View	–	1 (include 1 session usage from KA82 series to KG series)
Device View	Port View	2 (include 1 session usage from KA82 series to KG series)

For example, if the environment requires to use 2 displays with port view function on the KG series. The maximum server that can be accessed with the KG series would be 10 servers for KG0016 and 20 servers for KG0032. To find out the session usage, please refer to the *KG0016-KG0032 user manual* > *User Accounts* and select *Online User*.

ATEN Warranty Policy

The warranty policy may vary by product category and region of purchase. For details, please visit ATEN's official website, select your purchase counties/regions and then go to the Support Center, or contact your local ATEN sales representative for further assistance.

© Copyright 2025 ATEN® International Co., Ltd.
Released: 2025-07-03

ATEN and the ATEN logo are registered trademarks of ATEN International Co., Ltd. All rights reserved. All other brand names and trademarks are the registered property of their respective owners.