



**Power Over the NET™
PN5212 / PN5320
Power Distribution Unit
User Manual**



FCC, CE Information

FEDERAL COMMUNICATIONS COMMISSION INTERFERENCE STATEMENT: This equipment has been tested and found to comply with the limits for a Class A digital device, pursuant to Part 15 of the FCC Rules. These limits are designed to provide reasonable protection against harmful interference when the equipment is operated in a commercial environment. This equipment generates, uses, and can radiate radio frequency energy and, if not installed and used in accordance with the instruction manual, may cause harmful interference to radio communications. Operation of this equipment in a residential area is likely to cause harmful interference in which case the user will be required to correct the interference at his own expense.

FCC Caution: Any changes or modifications not expressly approved by the party responsible for compliance could void the user's authority to operate this equipment.

CE Warning: This is a class A product. In a domestic environment this product may cause radio interference in which case the user may be required to take adequate measures.

RoHS

This product is RoHS compliant.

SJ/T 11364-2006

The following contains information that relates to China.

部件名称	有毒有害物质或元素					
	铅	汞	镉	六价铬	多溴联苯	多溴二苯醚
电器部件	●	○	○	○	○	○
机构部件	○	○	○	○	○	○

- : 表示该有毒有害物质在该部件所有均质材料中的含量均在SJ/T 11363-2006规定的限量要求之下。
- : 表示符合欧盟的豁免条款, 但该有毒有害物质至少在该部件的某一均质材料中的含量超出SJ/T 11363-2006的限量要求。
- ×: 表示该有毒有害物质至少在该部件的某一均质材料中的含量超出SJ/T 11363-2006的限量要求。



User Information

Online Registration

Be sure to register your product at our online support center:

International	http://eservice.aten.com
---------------	---

Telephone Support

For telephone support, call this number:

International	886-2-8692-6959
China	86-10-5255-0110
Japan	81-3-5615-5811
Korea	82-2-467-6789
North America	1-888-999-ATEN ext 4988
United Kingdom	44-8-4481-58923

User Notice

All information, documentation, and specifications contained in this manual are subject to change without prior notification by the manufacturer. The manufacturer makes no representations or warranties, either expressed or implied, with respect to the contents hereof and specifically disclaims any warranties as to merchantability or fitness for any particular purpose. Any of the manufacturer's software described in this manual is sold or licensed *as is*. Should the programs prove defective following their purchase, the buyer (and not the manufacturer, its distributor, or its dealer), assumes the entire cost of all necessary servicing, repair and any incidental or consequential damages resulting from any defect in the software.

The manufacturer of this system is not responsible for any radio and/or TV interference caused by unauthorized modifications to this device. It is the responsibility of the user to correct such interference. The manufacturer is not responsible for any damage incurred in the operation of this system if the correct operational voltage setting was not selected prior to operation. PLEASE VERIFY THAT THE VOLTAGE SETTING IS CORRECT BEFORE USE.

PN Device Safety Notice



- ◆ Set the maximum permissible breaker protection in the building circuitry to the current rating specified on the rating plate. Observe all national regulations and safety codes as well as deviations for breakers.
- ◆ Only connect the PN Device to a grounded power outlet or a grounded system!
- ◆ Make sure that the total current input of the connected systems does not exceed the current rating specified on the rating plate of the PN Device.
- ◆ There is a risk of explosion if the battery is replaced with an incorrect type. Dispose of used batteries according to the relevant instructions.
- ◆ If the power source is unstable, the PN Device's measurements will not be accurate.

Consignes de sécurité relatives à l'unité PN



- ◆ Installez sur le circuit du bâtiment des disjoncteurs permettant d'assurer la protection maximale autorisée, en respectant le courant nominal spécifié sur la plaque signalétique. Veuillez respecter l'ensemble des réglementations nationales en vigueur et des codes de sécurité ainsi que les déviations recommandées pour les disjoncteurs.
- ◆ Ne connectez l'unité PN qu'à une prise de courant avec borne de terre ou à un système mis à la terre !
- ◆ Assurez-vous que le courant d'entrée total des systèmes connectés ne dépasse pas le courant nominal spécifié sur la plaque signalétique de l'unité PN.
- ◆ Il existe un risque d'explosion si la batterie est remplacée par une batterie de type incorrect. Jetez les batteries usagées en respectant les instructions adéquates.
- ◆ Si la source d'alimentation est instable, les mesures de l'unité PN seront inexactes.

Package Contents

The PN5212 / PN5320 package consists of:

- 1 PN5212 or PN5320 Power Distribution Unit
- 3 Serial Adapters:
 - 1 SA0149 (RJ45F to DB9F)
 - 1 SA0150 (RJ45F to DB9M)
 - 1 SA0151 (RJ45F to DB9F)
- 2 Mounting Kit
 - 1 User Instructions*
 - 1 Software CD

Check to make sure that all of the components are present and in good order. If anything is missing, or was damaged in shipping, contact your dealer.

Read this manual thoroughly and follow the installation and operation procedures carefully to prevent any damage to the switch or to any other devices on the PN5212 / PN5320 installation.

* Features may have been added to the PN5212 / PN5320 since this manual was published. Please visit our website to download the most up-to-date version of the manual.

Copyright © 2010–2013 ATEN® International Co., Ltd.
Manual Part No. PAPE-0321-AX2G
Printing Date: 2013-12-23

Altusen and the Altusen logo are registered trademarks of ATEN International Co., Ltd. All rights reserved. All other brand names and trademarks are the registered property of their respective owners.

Contents

FCC, CE Information	ii
RoHS	ii
SJ/T 11364-2006	ii
User Information	iii
Online Registration	iii
Telephone Support	iii
User Notice	iii
PN Device Safety Notice	iv
Consignes de sécurité relatives à l'unité PN	iv
Package Contents	v
About This Manual	xi
Conventions	xii
Product Information	xiii

Chapter 1.

Introduction

Overview	1
Features	2
Power Distribution	2
Remote Access	2
Operation	2
Management	3
Security	4
Requirements	4
Components	5
Front View	5
Port and Led Panel	7

Chapter 2.

Hardware Setup

Before You Begin	9
Rack Mounting	9
Single Stage Installation	11
Daisy Chaining	13
PN5212 / PN5320 to PN5212 / PN5320	13
PN5212 / PN5320 to PN0108	14

Chapter 3.

Super Administrator Setup

First Time Setup	15
Network Configuration	16
Changing the Administrator Login	17
Moving On	18

Chapter 4.**Browser Login**

Logging In	19
The PN5212 / PN5320 Main Page	20
Page Components	21

Chapter 5.**Outlet Access**

Overview	23
The Outlet Selection Sidebar	24
Manual Power Management	25
Connections	27
Station Level	27
Outlets	27
General	28
Groups	29
Outlet Level	30
General	30
Configuration	31
Server Diagnosis	31
Scheduling	32
Outlet Group Level	33
General	33
Schedule	33
User Preferences	34
Sessions	35
Access	35
Station Level	35
Outlet Level	36
Configuration	37
Station Level Configuration	37
General	38
Groups	39
Outlet Level Configuration	41
Configuration	41
Schedule	43

Chapter 6.**User Management**

Overview	45
Users	46
Adding Users	46
Modifying User Accounts	49
Deleting User Accounts	49
Moving On	49
Groups	50

Creating Groups	50
Modifying Groups	52
Deleting Groups	52
Users and Groups	53
Assigning Users to a Group From the Accounts Page	53
Removing Users From a Group From the Accounts Page	54
Assigning Users to a Group From the Groups Page	55
Removing Users From a Group From the Groups Page	56
Device Assignment	57
Assigning Device Permissions From the Accounts Menu	57
Assigning Device Permissions From the Groups Page	58

Chapter 7.

Device Management

Overview	59
Device Information	59
Network	61
Service Ports	61
Settings	62
IP Installer	62
IPv4 Configuration	63
IPv6 Configuration	64
ANMS	65
Event Notification	65
SMTP Settings	65
Log Server	66
SNMP Trap Receivers	67
Syslog Server	68
Finishing Up	68
Authentication & Authorization	69
Disable Local Authentication	69
RADIUS Settings	69
LDAP/AD Settings	70
TACACS+	72
Finishing Up	72
CC Management	73
SNMP Agent	74
OoBC	75
Console Port Settings	75
Security	76
Login String	77
IP and MAC Filtering	77
Adding Filters	78
IP Filter / MAC Filter Conflict	79
Modifying Filters	79
Deleting Filters	79

Account Policy	79
Private Certificate	80
Generating a Self-Signed Certificate	80
Obtaining a CA Signed SSL Server Certificate	80
Importing the Private Certificate	80
Customization	81
Login Failures	81
Working Mode	81
Date/Time	82
Time Zone	82
Manual Input	83
Network Time	83
Finishing Up	83

Chapter 8.

Log

Overview	85
System Log	85
The Log Event List	86
Search	87
Save	88
Notification Settings	89

Chapter 9.

Maintenance and Download

Overview	91
Maintenance	91
Firmware Upgrade	91
The Main Panel	92
Upgrading the Firmware	92
Firmware Upgrade Recovery	93
Backup/Restore	93
Backup	94
Restore	94
Download	95

Chapter 10.

The Log Server

Installation	97
Starting Up	98
The Menu Bar	99
Configure	99
Events	100
Search:	100
Maintenance:	101
Options	102

Help	102
The Log Server Main Screen	103
Overview	103
The List Panel	104
The Event Panel	104

Chapter 11.

Out of Band Operation

Overview	105
Console Terminal Session	105
Logging In	108

Chapter 12.

Remote Terminal Operation

Overview	109
Telnet	109
Logging In	109
SSH	111
Terminal Session (Linux):	111
Third Party Utility (Windows):	112

Appendix

Safety Instructions	113
General	113
Consignes de sécurité	115
Général	115
Rack Mounting	118
The eco PDU's Main Power Cord	118
Securing the Power Cables	118
Montage sur bâti	119
Le cordon d'alimentation principale de l'unité d'alimentation éco	119
Fixation des câbles d'alimentation	119
Technical Support	121
International	121
North America	121
IP Address Determination	122
Method 1:	122
Method 2:	123
Trusted Certificates	124
Overview	124
Installing the Certificate	125
Certificate Trusted	126
Mismatch Considerations	127
Self-Signed Private Certificates	128
Examples	128
Importing the Files	128
Troubleshooting	129

Administrator Login Failure 133
Specifications 134
Limited Warranty 135

About This Manual

This User Manual is provided to help you get the most from your PN5212 / PN5320 system. It covers all aspects of installation, configuration and operation. An overview of the information found in the manual is provided below. Chapters 1, 4, and 5 are for all users. The remaining chapters are for administrators and users with administrator privileges.

Chapter 1, *Introduction*, introduces you to the PN5212 / PN5320 system. Its purpose, features and benefits are presented, and its front and back panel components are described.

Chapter 2, *Hardware Setup*, provides step-by-step instructions for setting up your installation.

Chapter 3, *Super Administrator Setup*, explains the procedures that the super administrator employs to set up the PN5212 / PN5320 network environment, and change the default username and password.

Chapter 4, *Browser Login*, describes how to log in to the PN5212 / PN5320 with an internet browser, and explains the layout and components of the PN5212 / PN5320's user interface.

Chapter 5, *Outlet Access*, describes the Outlet Access page; how to configure the options it provides regarding outlet operation; and how to access and operate the PN5212 / PN5320's outlets.

Chapter 6, *User Management*, shows administrators how to create, modify, and delete users and groups, and authorize outlet access for them.

Chapter 7, *Device Management*, shows administrators, and users with device management permission how to configure and control overall Power Over the NET™ device operations.

Chapter 8, *Log*, explains how to use the PN5212 / PN5320's log feature to view the events that take place on the Power Over the NET™ installation.

Chapter 9, *Maintenance and Download*, describes the procedures for upgrading the PN5212 / PN5320's firmware; backing up and restoring the device's configuration settings; and downloading a stand-alone Java Client AP program to access the PN5212 / PN5320.

Chapter 10, *The Log Server*, explains how to install and configure the Log Server.

Chapter 11, *Out of Band Operation*, explains an alternative method to access the PN5212 / PN5320 in case the LAN that it resides on goes down, or it cannot be accessed with the usual browser based method for some reason.

Chapter 12, *Remote Terminal Operation*, describes how the PN5212 / PN5320 can be accessed via remote terminal sessions such as Telnet, SSH, and PuTTY.

An Appendix, provides specifications and other technical information regarding the PN5212 / PN5320.

Conventions

This manual uses the following conventions:

- | | |
|--|--|
| Monospaced | Indicates text that you should key in. |
| [] | Indicates keys you should press. For example, [Enter] means to press the Enter key. If keys need to be chorded, they appear together in the same bracket with a plus sign between them: [Ctrl+Alt]. |
| 1. | Numbered lists represent procedures with sequential steps. |
| ◆ | Bullet lists provide information, but do not involve sequential steps. |
| → | Indicates selecting the option (on a menu or dialog box, for example), that comes next. For example, Start → Run means to open the <i>Start</i> menu, and then select <i>Run</i> . |
|  | Indicates critical information. |

Product Information

For information about all ALTUSEN products and how they can help you connect without limits, visit ALTUSEN on the Web or contact an ALTUSEN Authorized Reseller. Visit ALTUSEN on the Web for a list of locations and telephone numbers

- ◆ International – <http://www.aten.com>
- ◆ North America – <http://www.aten-usa.com>

Chapter 1

Introduction

Overview

The PN5212 and PN5320 are power distribution units (PDUs) that contain 12 and 20 AC outlets, respectively, and are available in IEC or NEMA socket configurations. They provide secure, centralized, intelligent, power management (power on, off, cycle) of remote data center equipment (servers, KVM switches, network devices, serial data devices, etc.), as well as the ability to monitor the center's health environment. By daisy chaining up to 15 additional PN5212 or PN5320 units, as many as 320 outlets can be managed from a single interface.

The characteristics of each model are shown in the following table:

Model	Amps	Outlets
PN5212	16/20	12
PN5320	32/30	20

The power status of each outlet can be set individually, allowing users to establish on/off schedules for each device. Outlets can also be aggregated into groups, allowing groups of devices to be power managed at the same time, while On/Off sequencing enables users to set the power on sequence and delay time for each port to allow equipment to be turned on in the proper order.

Installation and operation is fast and easy: plugging cables into their appropriate ports and user-friendly browser-based configuration and management is all that is entailed. Serial access via modem, Telnet and SSH is also supported to ensure system availability.

Since the PN5212 / PN5320 firmware is upgradeable over the Net, you can stay current with the latest functionality improvements simply by downloading updates from our website as they become available.

With its advanced security features and ease of operation, the PN5212 / PN5320 is the most convenient, most reliable, and most cost effective way to remotely manage power access for multiple computer installations.

Features

Power Distribution

- ◆ Maximum Amps/Outlet: 20A / 12 outlets (PN5212); 30A / 20 outlets (PN5320)
- ◆ Space saving 0U rack mount design
- ◆ IEC or NEMA outlet models
- ◆ Daisy chain up to 15 additional stations for up to 192 (PN5212) or 320 (PN5320) outlets
- ◆ 2 x 7 segment front panel LED shows Station ID and Current / Voltage / Active Power
- ◆ Overcurrent protection and recovery (PN5320 only)
- ◆ Remote users can monitor outlet status via web pages on their browsers
- ◆ Safe shutdown support
- ◆ Separate power for the unit's own power and its power outlets. The user interface is still accessible even when an overload condition trips the devices' circuit breaker (PN5320 only)

Remote Access

- ◆ Remote power control via TCP/IP and a built in 10/100 Ethernet port
- ◆ Network Interfaces: TCP/IP, PPP, UDP, HTTP, HTTPS, SSL, SMTP, DHCP, ARP, NTP, DNS, Telnet, 10Base-T/100Base-TX, auto sense, Ping
- ◆ IPv6 support

Operation

- ◆ Local and Remote power outlet control (On, Off, Power Cycle) by individual outlets and outlet groups
- ◆ Outlet group support at the PDU and Daisy-chain levels – the same action can be performed on a specified group of outlets at the same time
- ◆ Supports redundant power management via daisy chaining and outlet groups
- ◆ On/Off scheduling for individual outlets and outlet groups. Power management tasks can be scheduled to perform everything on a daily, weekly, monthly, or user-specified times basis
- ◆ Supports multiple power on/off control methods – Wake on LAN, System After AC Back, Kill the Power

- ◆ Power-on sequencing - users can set the power on sequence and delay time for each port to allow equipment to be turned on in the proper order
- ◆ Auto-Ping function to determine device status
- ◆ Easy setup and operation via a browser-based user interface
- ◆ Multibrowser support (IE, Mozilla, Firefox, Chrome, Safari, Opera, Netscape)
- ◆ Telnet and SSH access for text menu configuration and outlet level switching / monitoring
- ◆ Local console access support
- ◆ Java GUI AP program provided for non-browser connectivity
- ◆ RTC support to keep the timer running during times of no power.
- ◆ Up to 64 user accounts - up to 32 concurrent logins

Management

- ◆ Power status measurement at the PDU level
- ◆ LED indicators for current, voltage and active power at the PDU level
- ◆ Real-time current, voltage, active power, and power dissipation displayed in a browsed-based UI for monitoring at the PDU and daisy-chained PDU levels
- ◆ Current, voltage, active power, and power dissipation threshold setting
- ◆ Alert notification for selected events (On, Off, Recycle, Failure, exceeding threshold settings, etc.), via audio alarm and blinking LEDs (locally), SMTP, SNMP trap notification, and digital output
- ◆ Supports Management Information Files (MIB) for SNMP
- ◆ Supports SNMP Manager V3
- ◆ Naming support for outlets and outlet groups
- ◆ User outlet access assignment on an outlet-by-outlet basis.
- ◆ Windows-based Log Server; event logging, KVM logging, and syslog support
- ◆ Integration with ALTUSEN CC2000 Management software
- ◆ API for 3rd party software centralized control integration
- ◆ Upgradeable firmware – daisy chained stations receive the upgrade via the daisy chain bus
- ◆ Multilanguage support: English, German, Traditional Chinese, Simplified Chinese, Japanese, Korean, Russian

Security

- ◆ Three-level password security
- ◆ IP/MAC filtering
- ◆ Strong security features include strong password protection and advanced encryption technologies – 128 bit SSL
- ◆ Remote authentication support: RADIUS, TACACS+, LDAP, LDAPS and Active Directory

Requirements

- ◆ Browsers accessing the PN5212 / PN5320 must support SSL 128 bit encryption.
- ◆ For cold booting of attached computers, the computer's BIOS must support *Wake on LAN* or *System after AC Back*.
- ◆ For Safe Shutdown:
 - ◆ The computer must be running Windows (Windows 2000 or higher) or Linux.
 - ◆ The *Safe Shutdown* program (available by download from our website or on the software CD included), must be installed and running on the computer.

Components

Front View

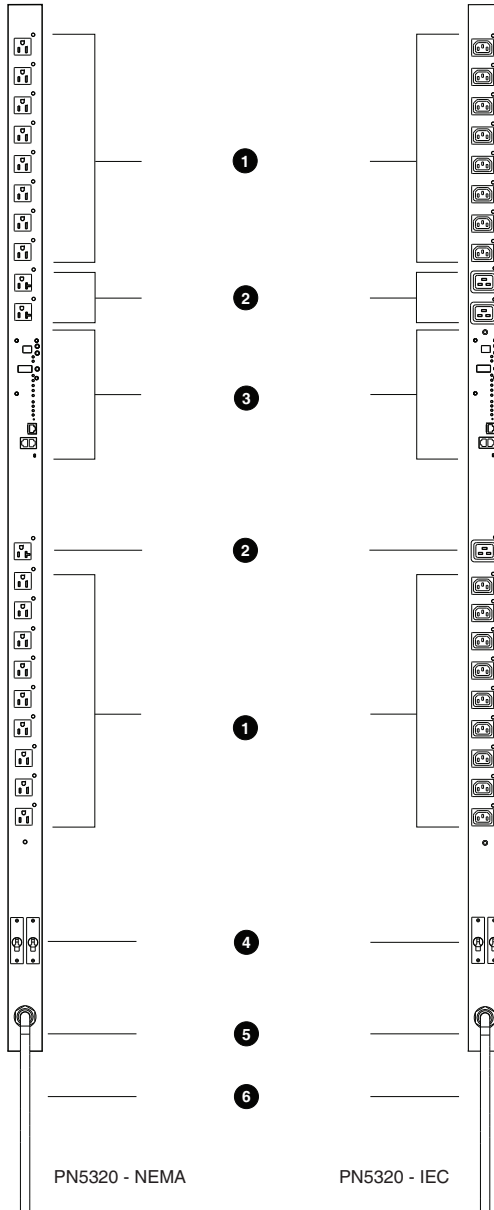

No.	Item	Description
1	Power Sockets	NEMA 5-15R – or – IEC320 C13
2	Power Sockets	NEMA 5-20R – or – IEC320 C19
3	Port and LED Panel	Details of this section are provided on the following page.
4	Circuit Breakers	PN5320 only. As a safety measure, if there is an overcurrent situation regarding the device's power, the circuit breakers will trip. Press the button to recover normal operation. Note: Circuit breakers are not provided on the PN5212. Therefore, it is not recommended to plug the unit directly into any unprotected power source, such as a wall outlet.
5	Grounding Terminal	The wire used to ground the unit connects here. Note: The grounding terminal does not appear in the diagram. It is hidden by the power cord.
6	Power Cord	Plug the cord into your AC source.

Note: The Front View diagram depicts a PN5320. The PN5212 is basically the same, except there are only 12 AC power sockets (6 on each side of the Port and LED panel), and all the sockets are NEMA 5-15R or IEC320 C13. There are no NEMA 5-20R or IEC320 C19 sockets. The PN5212 does not feature circuit breakers.

Port and Led Panel

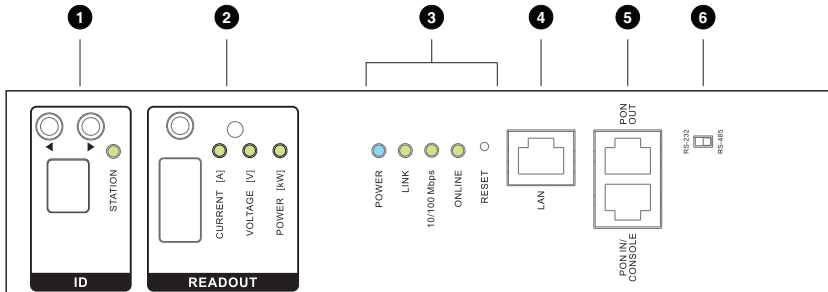

No.	Item	Description
1	Station Selection	<ul style="list-style-type: none"> ◆ Press the Left or Right button to move to the previous or next Station. ◆ The Station number appears in the display window.
2	Readout Section	<ul style="list-style-type: none"> ◆ The readouts for Current, Voltage, and Active Power appear in the display window. ◆ The LEDs above the items indicate which one the readout relates to. ◆ Press the button above the display window to cycle the selection among the items.
3	Status LEDs and Reset Switch	<p>Power: Lights when the PN5212 / PN5320 is powered up and ready to operate.</p> <p>Link: Lights GREEN to indicate that a connection via the PN5212 / PN5320's RJ-45 Ethernet port has been established. Flashes to indicate data is being transmitted.</p> <p>10/100 Mbps: Lights ORANGE to indicate 10 Mbps data transmission speed. The LED lights GREEN to indicate 100 Mbps data transmission speed.</p> <p>On Line: Lights to indicate that a connection to a KVM switch or a parent PDU has been established. Flashes to indicate that data is being transmitted.</p> <p>Reset Switch: ◆ This switch is recessed and must be pushed with a thin object, such as the end of a paper clip.</p> <ul style="list-style-type: none"> ◆ Press and release to reboot the device. ◆ Press and hold for more than three seconds to reset the PN5212 / PN5320 to its factory default settings (except for user account settings – they are not removed).
4	LAN Port	The cable that connects the PN5212 / PN5320 to the Internet, LAN, or WAN plugs in here.

No.	Item	Description
5	PON Out Port	<p>When daisy chaining PDUs, the cable that connects to the child device plugs in here.</p> <p>If the child device is a PN0108, you must use an SA0150 adapter to plug into the PN0108's PON In port (see <i>PN5212 / PN5320 to PN0108</i>, page 14, for details).</p>
6	RS-232/ RS-485 Switch	<p>Selects which protocol the PON In / Console port uses.</p> <ul style="list-style-type: none"> ◆ For <i>PON In</i> use, select RS-232 (for PN0108) or RS-485 ◆ For <i>Console</i> use, select RS-232 ◆ For <i>KVM switches</i>, select either RS-232 (can be used for shorter distances), or RS-485 (for longer distances). ◆ When daisy chaining PN5212 / PN5320 devices, set the switch to RS-232 on all child devices.
7	PON In / Console Port	<p>This is a multifunction port:</p> <p>PON In: When used as a <i>PON In</i> port, it can: 1) Daisy chain the device to a parent PDU; or 2) Connect the device to a KVM switch.</p> <p>If the parent PDU is a PN0108, you must use an SA0149 adapter to plug into the PN0108's PON Out port (see , page 14, for details).</p> <p>Console: When used as a <i>Console</i> port, it can establish a serial terminal connection to a computer. An SA0151 (DTE) adapter is required for this connection (see <i>Single Stage Installation</i>, page 11, for details).</p>

Chapter 2

Hardware Setup

Before You Begin



1. Important safety information regarding the placement of this device is provided on page 113. Please review it before proceeding.
2. The PN5212 requires a dedicated circuit. See *Package Contents*, page v, for important information about this matter.
3. Make sure that power to all the devices you will be connecting have been turned off. You must unplug the power cords of any computers that have the Keyboard Power On function.



1. Vous trouverez des informations de sécurité importantes concernant le positionnement de l'unité à la page 113.
2. L'unité PN5212 nécessite un circuit dédié. Le paragraphe page v, contient des informations importantes à ce propos. Veuillez le consulter.
3. Vérifiez que tous les périphériques à connecter sont éteints. Vous devez débrancher les câbles d'alimentation des ordinateurs disposant de la fonction de mise sous tension à partir du clavier.

Rack Mounting

The PN5212 / PN5320 can be installed in a 0U configuration on the side of a rack. To rack mount the device, use the rack mounting brackets that came with your device. The brackets can be mounted either near the top and bottom of the back panel, or the top and bottom ends of the device (see page 10), as shown in the diagrams below:

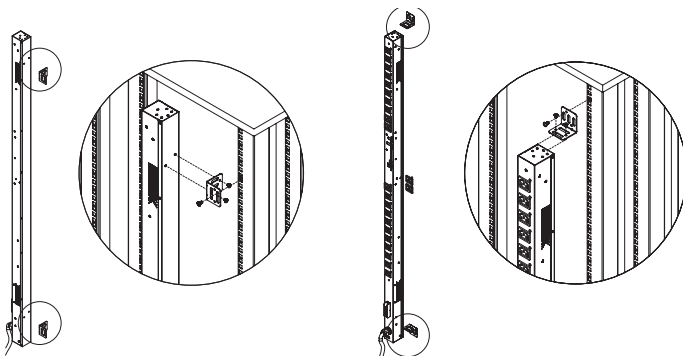

(Continued from previous page.)

The PN5212 / PN5320 comes supplied with top and bottom screws already inserted, as shown below:

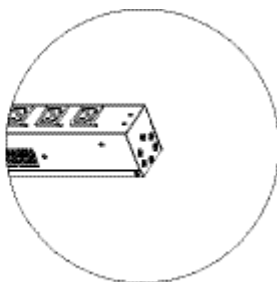
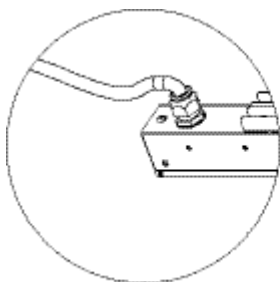

If you want to mount to brackets at the top and bottom ends of the device, you must first remove the screws from each end of the unit before attaching the mounting brackets:

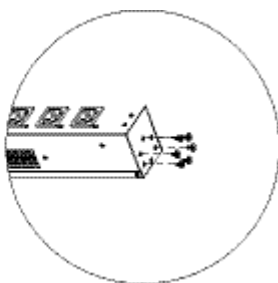
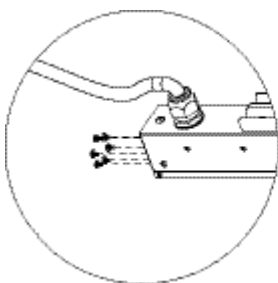

Single Stage Installation

In a single stage installation, there are no additional PN5212 / PN5320 stations daisy chained down from the first unit. To set up a single stage installation, refer to the installation diagram on the next page (the numbers in the diagram correspond to the numbered steps), and do the following:

1. Use a grounding wire to ground the PN5212 / PN5320 by connecting one end of the wire to its grounding terminal, and the other end of the wire to a suitable grounded object.

Note: Do not omit this step. Proper grounding helps to prevent damage to the unit from surges or static electricity.

2. For each device you want to connect, use its power cable to connect from the device's AC socket to any available outlet on the PN5212 / PN5320.
3. Plug the cable that connects the PN5212 / PN5320 to the LAN into the PN5212 / PN5320's LAN port.
4. (Optional) If you wish to use a console terminal connection, use Cat 5e cable to connect the PN5212 / PN5320's PON IN/Console port to the SA0151 (DTE) adapter supplied with your package. Connect the adapter's serial connector to the COM port of the computer you will use for the console terminal.
5. Connect the PN5212 / PN5320's power cord to an AC power source.

Note: 1. We strongly advise that you do not plug the PN5212 / PN5320 into a multi socket extension cord, since it may not receive enough amperage to operate correctly.

2. Circuit breakers are not provided on the PN5212. Therefore, it is not recommended to plug the unit directly into any unprotected power source, such as a wall outlet. See *Package Contents*, page v.
-

Once you have finished these installation steps, you can turn on the PN5212 / PN5320 and the connected devices.

Note: We strongly recommend using cable ties and cable bars to safely and securely route the cables attached to the back of the unit.

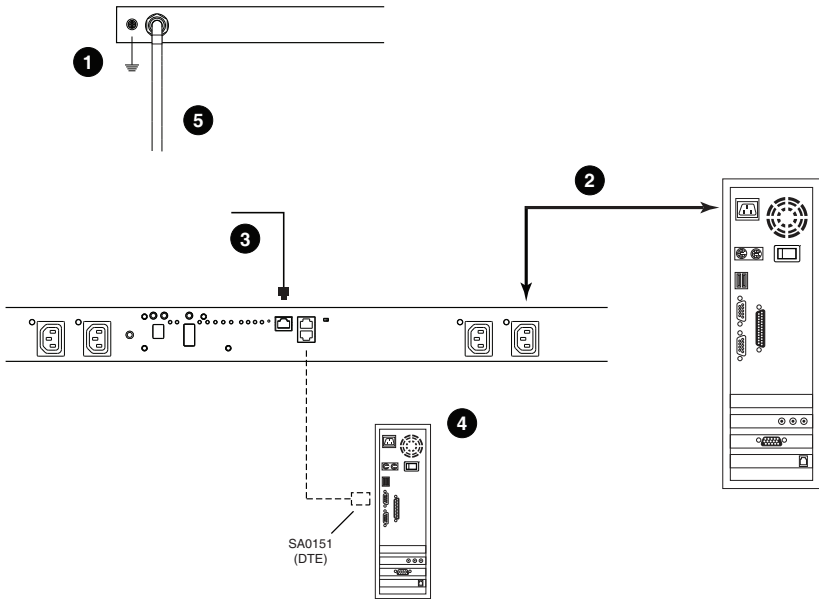

Daisy Chaining

To manage even more outlets from the same single session as a standalone PN5212 / PN5320, additional Power Over the NET™ devices can be daisy chained, as described in the following three configurations.

Note: The maximum distance between any two Power Over the NET™ devices must not exceed 15 m; the total distance from the first station to the last must not exceed 100 m.

PN5212 / PN5320 to PN5212 / PN5320

Up to 15 additional PN5212 / PN5320 stations can be daisy chained down from the top level (master) device – allowing up to 320 outlets to be managed on a complete installation. To daisy chain a PN5212 / PN5320, do the following:

1. Set the *RS-232/RS-485 switch* (see page 8), of the child device to the RS-232 setting.
2. Use Cat 5e cable to connect the PON OUT port of the parent device to the PON IN port of the child device.
3. Repeat the procedure for any additional devices you wish to connect.

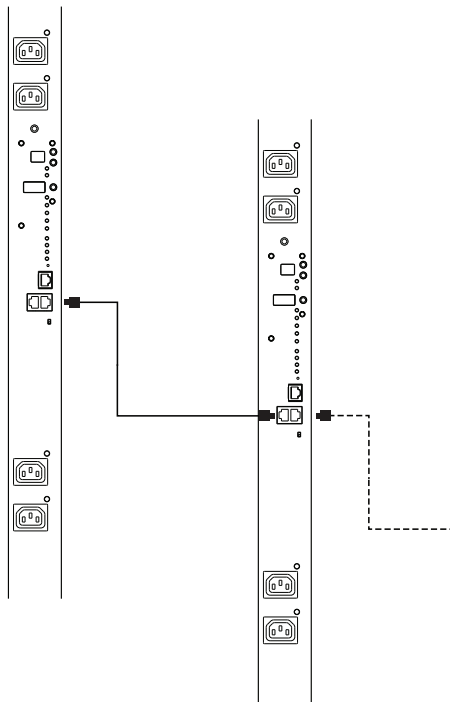

PN5212 / PN5320 to PN0108

To daisy chain a child PN0108 from a parent PN5212 / PN5320, do the following:

1. Use Cat 5e cable to connect the PN5212 / PN5320's PON OUT port to the SA0150 Adapter supplied with your package.
2. Connect the SA0150 to the PN0108's PON IN port.

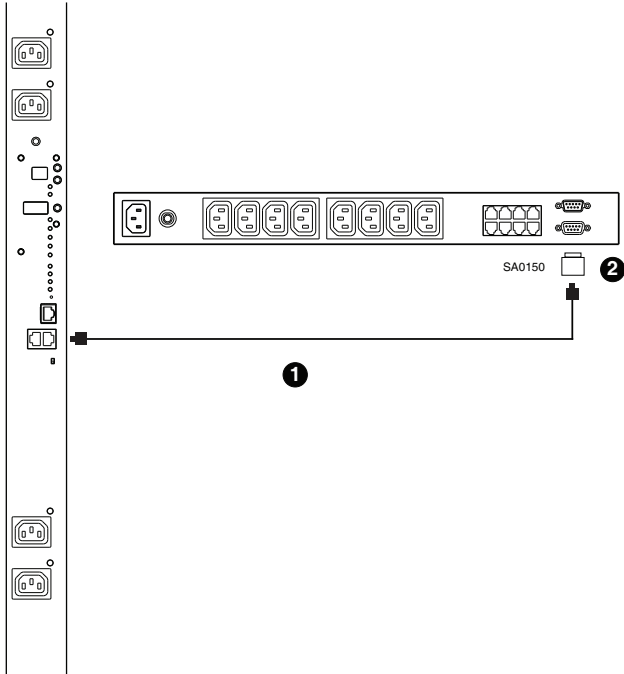

Note: In this configuration, the PN0108 would be connected to a KVM switch that supports Power Over the NET™ devices (such as the KN4140v), through its PON IN port, and the PON devices would be managed through the KVM switch's interface.

Chapter 3

Super Administrator Setup

First Time Setup

Once the PN5212 / PN5320 installation has been cabled up, the next tasks the Administrator needs to perform involve configuring the network parameters, changing the default Super Administrator login settings, and adding users.

The easiest way to accomplish this is to log in over the Net with a browser (see *Logging In*, page 19).

- Note:**
1. Since this is the first time you are logging in, use the default Username: *administrator*; and the default Password: *password*. For security purposes we recommend changing them to something unique (see *Changing the Administrator Login*, page 17).
 2. For remote methods of getting logged in to the network, see *IP Address Determination*, page 122.

After you successfully log in the PN5212 / PN5320 Main Page appears:

The screenshot shows the ALTUSCAN web interface for a PN5320 device. The top navigation bar includes links for Outlet Access, User Management, Device Management, Log, Maintenance, and Download. The main content area is titled 'Configuration' and shows the following data:

Device Status				
Device Name	Voltage	Current	Power	Power Dissipation
PN5320	0 V	0.00 A	0 W	0.00 kWh

Bank Status					
Bank	Bank Name	Voltage	Current	Power	Power Dissipation
Bank 1	Bank1	114 V	0.00 A	0 W	0.00 kWh
Bank 2	Bank2	114 V	0.00 A	0 W	0.00 kWh

Outlet Status		
Outlet	Outlet Name	Outlet Status
[01]		<input checked="" type="checkbox"/> SW <input type="checkbox"/> #reboot
[02]		<input type="checkbox"/> SW <input type="checkbox"/> #reboot
[03]		<input type="checkbox"/> SW <input type="checkbox"/> #reboot
[04]		<input type="checkbox"/> SW <input type="checkbox"/> #reboot
[05]		<input checked="" type="checkbox"/> SW <input type="checkbox"/> #reboot
[06]		<input type="checkbox"/> SW <input type="checkbox"/> #reboot

Network Configuration

To set up the network, do the following:

1. Click the **Device Management** tab.
2. Select **Network** on the menu bar. A screen similar to the one below appears:

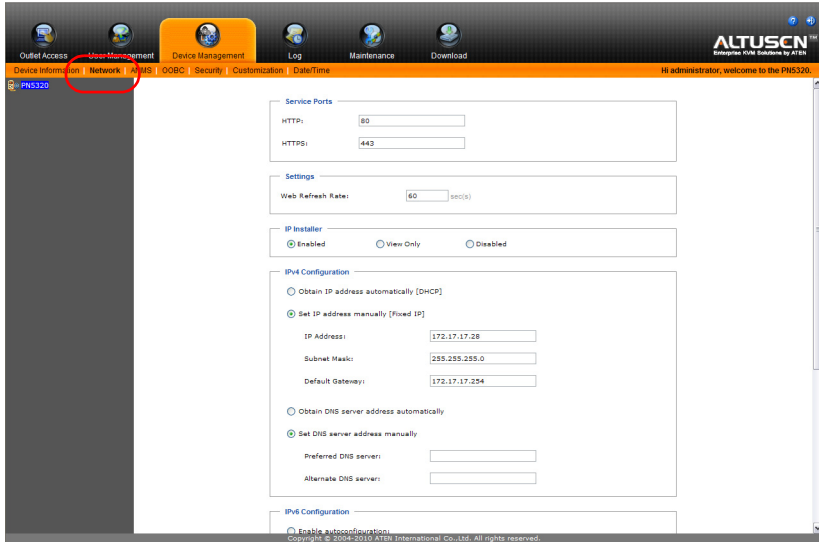

The screenshot shows the ALTUSCEN web interface for network configuration. The top navigation bar includes tabs for Device Access, Device Management (selected), Device Management, Log, Maintenance, and Download. Below this, a secondary menu bar shows options like Device Information, Network (highlighted with a red circle), DNS, QoS, Security, Customization, and Date/Time. The main content area is titled "Hi administrator, welcome to the PN5320." and contains several configuration sections:

- Service Ports:** HTTP (80), HTTPS (443)
- Settings:** Web Refresh Rate (60 sec)
- IP Installer:** Enabled (selected), View Only, Disabled
- IPv4 Configuration:**
 - Obtain IP address automatically [DHCP] (radio button)
 - Set IP address manually [Fixed IP] (radio button, selected)
 - IP Address: 172.17.17.28
 - Subnet Mask: 255.255.255.0
 - Default Gateway: 172.17.17.254
 - Obtain DNS server address automatically (radio button)
 - Set DNS server address manually (radio button, selected)
 - Preferred DNS server: []
 - Alternate DNS server: []
- IPv6 Configuration:** []

At the bottom, there is a copyright notice: "Copyright © 2004-2010 ATEN International Co., Ltd. All rights reserved."

3. Fill in the fields according to the information provided under *Network*, page 61.

Changing the Administrator Login

To change the default Super Administrator username and password, do the following:

1. Click the **User Management** tab.

The User Management page has a list of Users and Groups in the Sidebar at the left, and a more detailed list of users – with more information about them – in the large central panel. Since this is the first time the page is being accessed, only the Super Administrator appears:

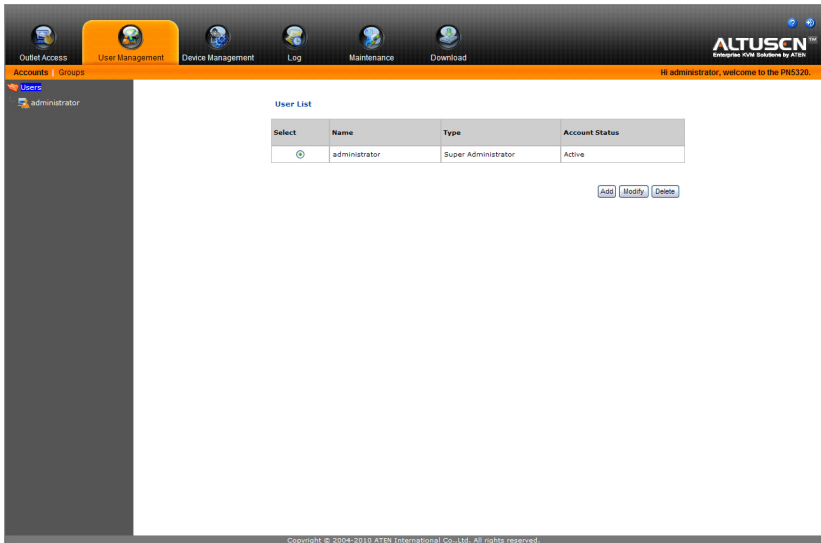

2. Click **administrator** in the Sidebar
– or –

Select *administrator* in the central panel, then click **Modify** (at the bottom of the page.)

(Continues on next page.)

(Continued from previous page.)

The User *General* page appears:

The screenshot shows the 'User General' configuration page. At the top, there are three tabs: 'User', 'Groups', and 'Devices'. The 'User' tab is selected. Below the tabs, the form is organized into four sections:

- General:** Contains three text input fields: 'User Name' (with the value 'administrator'), 'Password' (masked with asterisks), and 'Confirm Password' (masked with asterisks).
- User Type:** Contains three radio button options: 'Super Admin' (selected), 'Admin', and 'User'.
- Permissions:** Contains six checked checkboxes: 'User Management', 'Maintenance', 'Select All', 'Device Management', 'Java Client', and 'Log'.
- Status:** Contains several options:
 - Disable Account
 - Account never expires
 - Account expires on: 2010-01-01 (with a calendar icon)
 - User must change password at next logon
 - User cannot change password
 - Password never expires
 - Password Expires After: 0 days

A 'Save' button is located at the bottom right of the form.

3. Change the Username and Password to something unique.
4. Re-enter the password to confirm it is correct.
5. Click **Save**.
6. When the dialog box informing you that the change completed successfully appears, Click **OK**.

Moving On

After setting up the network and changing the default Administrator username and password, you can proceed to other administration activities – including adding users. Administration is discussed in detail in Chapter 4.

Chapter 4

Browser Login

Logging In

The PN5212 / PN5320 can be accessed via a supported Internet browser from any platform.

Note: Browsers must support SSL 128 bit encryption.

To access the PN5212 / PN5320 do the following:

1. Open your browser and specify the IP address of the PN5212 / PN5320 you want to access in the browser's URL location bar.

Note: 1. Get the IP address from the PN5212 / PN5320 administrator

2. If you are the administrator, and are logging in for the first time, see *First Time Setup*, page 15.
-

2. If a Security Alert dialog box appears, accept the certificate – it can be trusted. (See *Trusted Certificates*, page 124, for details.) The Login page appears:

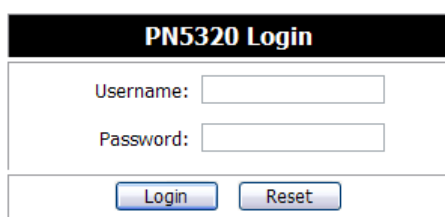

The image shows a web browser window displaying the login page for a PN5320 device. The page has a black header with the text "PN5320 Login" in white. Below the header, there are two input fields: "Username:" and "Password:". At the bottom of the form, there are two buttons: "Login" and "Reset".

3. Provide a valid Username and Password (set by the PN5212 / PN5320 administrator), then Click **Login** to bring up the browser Main Page.

The PN5212 / PN5320 Main Page

After you have successfully logged in, the PN5212 / PN5320 Main Page comes up with the Outlet Access *Connections* page displayed:

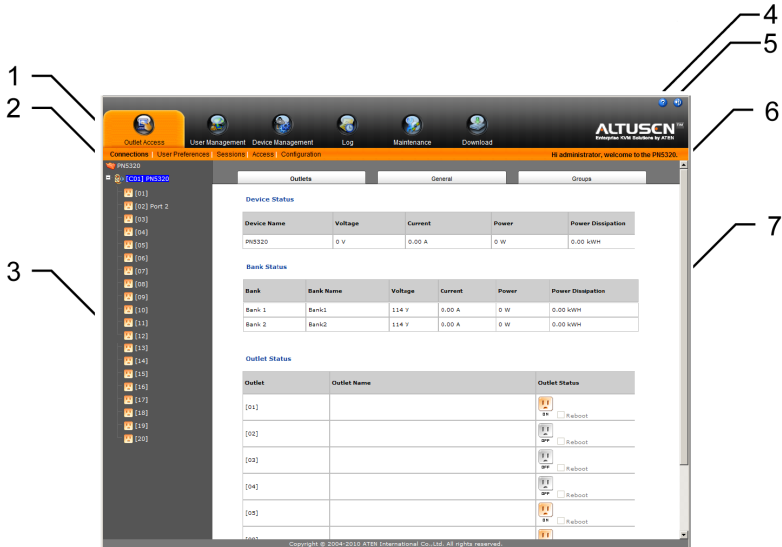

Note: 1. The screen depicts a Super Administrator's page. Depending on a user's type and permissions, not all of these elements appear.

2. Clicking the Altusen logo (at the top-right of the page), takes you to the ATEN website.

Page Components

The web page screen components are described in the table, below:

No.	Item	Description
1	Tab Bar	The tab bar contains the Power Over the NET™'s main operation categories. The items that appear in the tab bar are determined by the user's type, and the authorization options that were selected when the user's account was created.
2	Menu Bar	The menu bar contains operational sub-categories that pertain to the item selected in the tab bar. The items that appear in the menu bar are determined by the user's type, and the authorization options that were selected when the user's account was created.
3	Sidebar	The Sidebar provides a tree view listing of stations and outlets that relate to the various tab bar and menu bar selections. Clicking a node in the Sidebar brings up a page with the details that are relevant to it.
4	About/Help	About provides information regarding the switch's current firmware version. Help provides on-line help for the device's configuration and operation.
5	Logout	Click this button to log out of your Power Over the NET™ session.
6	Welcome Message	If this function is enabled (see <i>User Preferences</i> , page 34), a welcome message displays here.
7	Interactive Display Panel	This is your main work area. The screens that appear reflect your menu choices and Sidebar node selection.

This Page Intentionally Left Blank

Chapter 5

Outlet Access

Overview

When you log in to the PN5212 / PN5320, the UI opens with its default selection of the *Outlet Access* tab; the *Connections* menu; and the *Outlets* submenu. The contents of the Outlets submenu are displayed in the main panel.

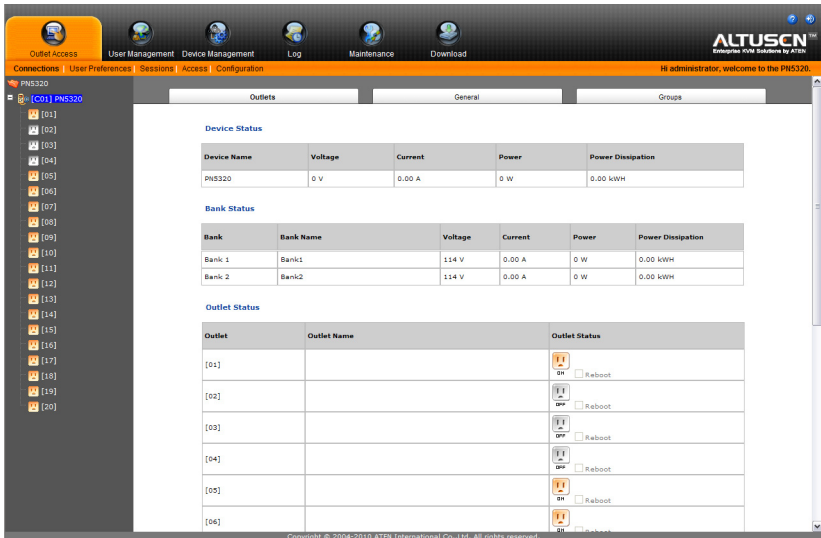

The main panel Outlets display provides a listing of each outlet a user is permitted to access, as well as a means of accessing the outlets. All the outlets that a user is permitted to access are also listed in the Sidebar at the left of the page.

The Outlet Selection Sidebar

All stations and their outlets – including cascaded stations and their outlets – are listed in a tree structure in the Sidebar at the left of the screen. Outlet groups are listed at the bottom of the tree:

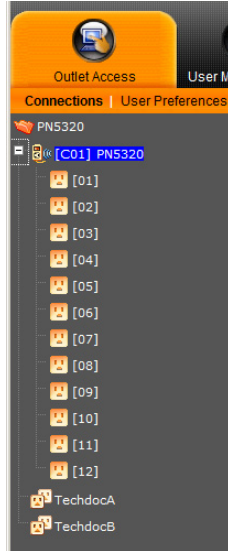

- ◆ Users are only allowed to see the stations and outlets that they have access permission for.
- ◆ Outlets and child stations may be nested under their parent stations. Click the + in front of a station to expand the tree and see the nested outlets. Click the - to collapse the tree and hide the nested outlets.
- ◆ An outlet's ID number is displayed in brackets next to the outlet icon. For convenience the outlets can be named (See *Configuration*, page 37 for details). If an outlet has been named, its name appears next to the outlet ID.
- ◆ Outlet groups are identified by a double socket icon.

- ◆ The outlet's icon color indicates its status as explained in the table, below:

Icon	Status
Steady Amber	Power to the outlet is On.
Flashing Amber	A change in the outlet's power status is pending. (See <i>Shutdown Method</i> , page 42)
Steady Gray	Power to the outlet is Off.
Flashing Gray	Power to the outlet is Off, but Wake On LAN has been specified as the remote power option. (See <i>Shutdown Method</i> , page 42.)
Flashing Lightbulb	Indicates an outlet status error. A firmware upgrade may resolve the problem.

- ◆ Clicking a Station icon opens its *General*, and *Groups* pages.
- ◆ Clicking an Outlet icon opens its *Configuration* and *Schedule* pages.
- ◆ Clicking a Group icon opens its *General* and *Schedule* pages.

Manual Power Management

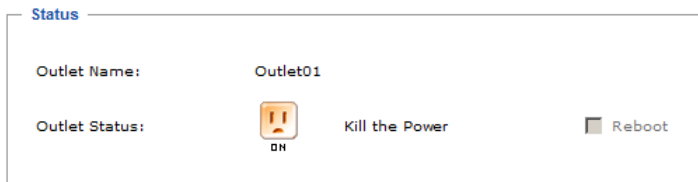

In addition to automated power management (see *To configure the schedule, select Configuration at the far right of the menu bar. See Schedule, page 43 for details*, page 32), an Outlet or a Group's power can be managed manually. Clicking the outlet or group's icon in the Sidebar brings up its *General* page:

Outlet General Page



Group General Page

Status:

Group Name:	TechdocA
Group Member:	[C01-01] [C01-02] [C01-03]
Group ON/OFF:	 

With the exception of the power outlet icon, the pages are view only and provide power status and usage information. To configure the settings, select *Configuration* at the far right of the menu bar. See *Configuration*, page 37 for details.

The color of the power outlet icon indicates its status (as explained in the table on page 25). The power status of the outlet can be changed by clicking the icon.

-
- Note:**
1. The Outlet page's *Reboot* checkbox is only enabled when the shutdown method is either *Wake on Lan* or *System after AC Back*, and the outlet status is On. If the box is enabled and checked, clicking the power outlet icon causes the connected device to reboot, rather than shut down. See *Shutdown Method*, page 42, for further information.
 2. When you click the icon to change the outlet's power status, the icon flashes to indicate the change, but the icon doesn't change to the new color at this time. You must leave the page and come back to it in order to see the changed color.
 3. When you click the icon to change the outlet's power status, the color of the outlet's icon in the Sidebar doesn't immediately change to the new color. You must leave the *Connections* page and come back to it in order to see the changed color.
 4. For Outlet Groups, all of the outlets in the group turn On or Off together.
-

Connections

The *Connections* pages provide status and settings information for stations, outlets, and outlet groups. The pages that come up in the main panel differ depending on which item is selected in the Sidebar.

Station Level

When a station is selected in the Sidebar, the main panel page has three tabs: *Outlets*, *General*, and *Groups*:

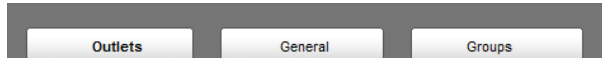

Outlets

The station's *Outlets* page displays status information for that device, each bank, and each of its power outlets:





Device Status

Device Name	Voltage	Current	Power	Power Dissipation
PNS320	113 V	0.00 A	0 W	37.85 kWH

Bank Status

Bank	Bank Name	Voltage	Current	Power	Power Dissipation
Bank 1	Bank1	113 V	0.00 A	0 W	17.03 kWH
Bank 2	Bank2	113 V	0.00 A	0 W	20.82 kWH

Outlet Status

Outlet	Outlet Name	Outlet Status
[01]		 <input type="checkbox"/> Reboot
[02]		 <input type="checkbox"/> Reboot
[03]		 <input type="checkbox"/> Reboot
[04]		 <input type="checkbox"/> Reboot

Note: You can manually manage the outlet's power status by clicking the power outlet icon. See *Manual Power Management*, page 25 for details.

General

The station's *General* page shows the station's settings configuration:

Settings

Device Name:

Load Alarm: Disabled

Device Threshold Settings

	Minimum	Maximum	Fluctuation
Current Threshold:	<input type="text"/> A	<input type="text"/> A	<input type="text"/> A
Voltage Threshold:	<input type="text"/> V	<input type="text"/> V	<input type="text"/> V
Power Threshold:	<input type="text"/> W	<input type="text"/> W	<input type="text"/> W
Power Dissipation Threshold:		<input type="text"/> kWh	

Bank Threshold Settings

Bank 1:

	Minimum	Maximum	Fluctuation
Current Threshold:	<input type="text"/> A	<input type="text"/> A	<input type="text"/> A
Voltage Threshold:	<input type="text"/> V	<input type="text"/> V	<input type="text"/> V
Power Threshold:	<input type="text"/> W	<input type="text"/> W	<input type="text"/> W
Power Dissipation Threshold:		<input type="text"/> kWh	

Bank 2:

	Minimum	Maximum	Fluctuation
Current Threshold:	<input type="text"/> A	<input type="text"/> A	<input type="text"/> A
Voltage Threshold:	<input type="text"/> V	<input type="text"/> V	<input type="text"/> V
Power Threshold:	<input type="text"/> W	<input type="text"/> W	<input type="text"/> W
Power Dissipation Threshold:		<input type="text"/> kWh	

This page only displays information. Settings changes cannot be made here. To configure the settings, select *Configuration* at the far right of the menu bar. See *Configuration*, page 37 for details.

Groups

The station's *Groups* page lists the names of the outlet groups that have been created with its outlets in the left column. The outlets that make up the group are in the right column:

Settings

Outlet Group

Group	Outlets
TechdocA	[C01-01] [C01-05] [C01-13] [C01-15]
TechdocB	[C01-01] [C01-06] [C01-11] [C01-16] [C01-20]

The outlets are displayed as [Station ID-Outlet Number]. For example, [C01-05] refers to outlet number 5 belonging to station number 1.

This page only displays information. Settings changes cannot be made here. To configure Outlet Groups, select *Configuration* at the far right of the menu bar. See *Groups*, page 39 for outlet group management details.

Outlet Level

When an outlet is selected in the Sidebar, the main panel tabs change to: *General*, *Configuration*, and *Scheduling*:



Each of the tabs is described below.

General

The outlet's *General* page provides information regarding the outlet's name and power status:

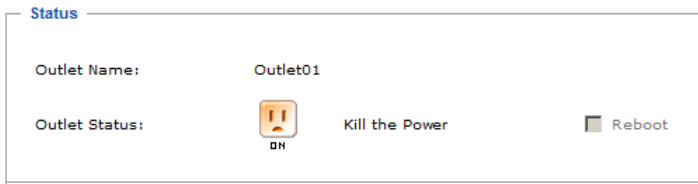

You can manually turn the outlet On and Off from this page by clicking the power outlet icon (see *Manual Power Management*, page 25 for details).

Configuration

The outlet's *Configuration* page summarizes the various configuration settings that have been made for the outlet:

The screenshot shows two sections of the configuration page. The top section, titled "Configuration", includes fields for "Outlet Name", "Confirmation Required" (checked "Enable"), "Power On Delay" (5 sec), "Power Off Delay" (1 sec), "Shutdown Method" (Kill the Power), and "MAC Address". The bottom section, titled "Server Diagnosis", includes an "Auto Ping" checkbox (unchecked), "Ping Address" (192.168.95.95), "Interval" (1), "Fail Count" (10), and "Action" (Send email).

The *Configuration* section only displays information. Setting changes cannot be made here. To configure the settings, select Configuration at the far right of the menu bar. See *Configuration*, page 37 for details.

Server Diagnosis

The *Server Diagnosis* section allows you to use an ICMP ping command to check if the outlet is functioning properly. This function is detailed in the following table:

Enable	Put a check in the checkbox to enable this function.
Ping Address	Enter the IP address of the outlet to be pinged in this field.
Interval	This field sets how often the specified outlet is pinged, in second intervals. Enter a value between 1 and 255.
Fail Count	This field sets how many times the outlet is allowed to fail to respond to the ping before an action is taken (see below). Enter a value between 1 and 99.
Action	This field sets what action is taken if the outlet fails to respond to a specified number of pings. Select one of the following actions from the drop-down menu: Send email: This sends an email using the SMTP server setting. For this function to work, you must also enable reports from the SMTP server. See <i>SMTP Settings</i> , page 65 for details. No action: Select this option to do nothing if the specified device fails to respond.

Scheduling

The outlet's *Scheduling* page shows the date and time schedule settings for automatic power control of the outlet:

– [Status](#) —————

Routine Type	Start Date	End Date	Day	Shutdown Time(HH:MM)	Restart Time(HH:MM)
--------------	------------	----------	-----	----------------------	---------------------

To configure the schedule, select *Configuration* at the far right of the menu bar. See *Schedule*, page 43 for details

Outlet Group Level

When an outlet group is selected in the Sidebar, the main panel tabs change to *General*, and *Schedule*.

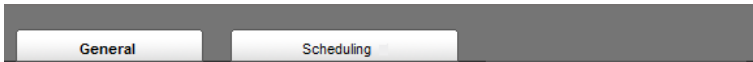



Each of the tabs is described below.

General

The outlet group's *General* page provides information regarding the group's name, the outlets that belong to the group, and the power status of the outlets:

Status:

Group Name:	TechdocA
Group Member:	[C01-01] [C01-02] [C01-03]
Group ON/OFF:	 

You can manually turn the outlets On and Off from this page by clicking the power outlet icon (see *Manual Power Management*, page 25 for details).

Note: All of the outlets in the group turn On or Off together.

Schedule

The outlet group's *Schedule* page shows the date and time schedule settings for automatic power control of the outlet group. This page is similar to the Outlet Schedule page discussed in the previous section.

User Preferences

The *User Preferences* page allows users to set up their own, individual, working environments. The PN5212 / PN5320 stores a separate configuration record for each user profile, and sets up the working configuration according to the *Username* that was keyed into the Login dialog box.

The screenshot shows a 'Settings' dialog box with the following fields and options:

- Language:** A dropdown menu currently set to 'English'.
- Logout Timeout:** A text input field containing '180' followed by 'min (0-180)'.
- Beeper:** A checked checkbox.
- Welcome Message:** A checked checkbox.
- Old Password:** An empty text input field.
- New Password:** An empty text input field.
- Confirm Password:** An empty text input field.

A 'Save' button is located at the bottom right of the dialog box.

Make your settings changes according to the information given in the following table:

Setting	Function
Language	Selects the language that the interface displays in. Drop down the list of available languages to choose the one you want.
Logout Timeout	If there is no user input for the amount of time set with this function, the user is automatically logged out. A login is necessary before the PN5212 / PN5320 can be accessed again. Key in a value from 0–180 minutes. Note: A setting of 0 (zero) disables this function, in which case users are never automatically logged out, no matter how much time passes.
Beeper	If this is enabled (there is a check in the checkbox), the beeper sounds whenever any of the following conditions occur: the PN5212 / PN5320 is powered On; whenever an environment alarm is triggered; whenever a device level alarm is triggered; whenever an outlet level alarm is triggered. Note: This is the master alarm setting. If it is not enabled, no alarms will sound – even if they are enabled on the Station Level configuration pages. (See page 41.)
Welcome Message	If this is enabled, a welcome message appears at the right side of the menu bar.
Password Fields	To change the user password, first key the old password into the <i>Old Password</i> input box, then key the new password into the <i>New Password</i> and <i>Confirm Password</i> input boxes.

Sessions

The *Session* page shows all of the users currently logged into the PN5212 / PN5320, and provides information about each of their sessions.

Select	User Name	IP	Login Time	Client	User Type
<input checked="" type="radio"/>	administrator	10.0.13.229	2010/06/05 01:10:48	HTTPS	Super Administrator
<input type="radio"/>	rjf111	10.0.13.229	2010/06/05 04:13:10	HTTPS	Administrator
<input type="radio"/>	frosty	10.0.13.228	2010/06/05 04:19:34	HTTPS	User

End Session

- ◆ The information under the *IP* heading indicates the IP address that the user is logged in from.
- ◆ The information under the *Client* heading indicates whether the user has logged in via a browser connection (HTTPS), or from a local console.
- ◆ Administrators have the option of forcing user logouts by selecting the user and clicking **End Session**.



Access

The *Access* page provides a way to assign permissions to users and groups at both the station level and individual power outlet levels. The items available differ depending on whether a station or an outlet is selected in the Sidebar.

Station Level

When a station is selected in the Sidebar, a page similar to the one below, displays in the main panel, with users and user groups listed in the left column.:

Access Information

Name	User Management	Device Management	Log	Maintenance	Java Client
 administrator	<input checked="" type="checkbox"/>	<input checked="" type="checkbox"/>	<input checked="" type="checkbox"/>	<input checked="" type="checkbox"/>	<input checked="" type="checkbox"/>
 rjf111	<input checked="" type="checkbox"/>	<input checked="" type="checkbox"/>	<input checked="" type="checkbox"/>	<input checked="" type="checkbox"/>	<input checked="" type="checkbox"/>
 frosty	<input type="checkbox"/>	<input type="checkbox"/>	<input type="checkbox"/>	<input type="checkbox"/>	<input checked="" type="checkbox"/>

Save



- ◆ A check mark indicates the user or user group is authorized to perform the task indicated in the column head.
- ◆ The permissions are the same ones assigned under user accounts. See *Permissions*, page 47 for details.

When you have made your settings on this page, click **Save**.

Outlet Level

When an outlet is selected in the Sidebar, a page similar to the one below, comes up in the main panel:

Access Information

Name	Access	Outlet Configuration
 administrator	<input checked="" type="checkbox"/>	<input checked="" type="checkbox"/>
 RD1	<input type="checkbox"/>	<input type="checkbox"/>

Save

Users and groups are listed alphabetically in the left column.

- ◆ A check mark under the *Access* column, indicates the user or group is authorized to access and power control the selected outlet.
- ◆ A check mark under the *Outlet Configuration* column, indicates the user or group is authorized to configure the selected outlet's settings (see *Configuration*, page 37).

When you have made your settings on this page, click **Save**.

Configuration

The *Configuration* page is used to configure the operation of the PN5212 / PN5320 at both the station level and the individual power outlet level. The items available differ depending on whether a station or an outlet is selected in the Sidebar.

Station Level Configuration

When a station is selected in the Sidebar, a page similar to the one below, displays in the main panel.

Settings

Device Name:

Load Alarm: Disabled

Device Threshold Settings

	Minimum	Maximum	Fluctuation
Current Threshold:	<input type="text"/> A	<input type="text"/> A	<input type="text"/> A
Voltage Threshold:	<input type="text"/> V	<input type="text"/> V	<input type="text"/> V
Power Threshold:	<input type="text"/> W	<input type="text"/> W	<input type="text"/> W
Power Dissipation Threshold:		<input type="text"/> kWh	

Bank Threshold Settings

Bank 1:

	Minimum	Maximum	Fluctuation
Current Threshold:	<input type="text"/> A	<input type="text"/> A	<input type="text"/> A
Voltage Threshold:	<input type="text"/> V	<input type="text"/> V	<input type="text"/> V
Power Threshold:	<input type="text"/> W	<input type="text"/> W	<input type="text"/> W
Power Dissipation Threshold:		<input type="text"/> kWh	

Bank 2:

	Minimum	Maximum	Fluctuation
Current Threshold:	<input type="text"/> A	<input type="text"/> A	<input type="text"/> A
Voltage Threshold:	<input type="text"/> V	<input type="text"/> V	<input type="text"/> V
Power Threshold:	<input type="text"/> W	<input type="text"/> W	<input type="text"/> W
Power Dissipation Threshold:		<input type="text"/> kWh	

The station level Configuration page has two tabs: *General*, and *Groups*, as described in the sections that follow.

General

When the *Configuration* page opens, the station's *General* page is selected. This page allows you to set up a power management configuration for the device as a whole. The meanings of the field headings are given in the following table:

Heading	Meaning
Device Name	To make things more convenient on a multi-station installation, each station can be given a distinctive name. To name a station key in the name of your choice - up to 32 letters and numbers.
Load Alarm	A checkmark in the check box disables an alarm from being triggered when the device's current load falls outside of its specified range.
Device Threshold Settings	<p>These fields are used to set the maximum, minimum, and fluctuation threshold settings. If a range falls below the minimum setting, or exceeds the maximum setting an alarm is triggered.</p> <p>In order to keep alarms from being constantly triggered due to slight fluctuations at the threshold points, you can set a fluctuation range that must be exceeded when a threshold is crossed in order for the alarm to be triggered.</p> <p>For example, if there is a temperature threshold of 32° and you set a fluctuation range of 2°, there won't be an alarm triggered if the temperature fluctuates back and forth between 31 and 32°.</p>
Temperature Unit	Click a radio button to choose the temperature unit for the temperature sensor.
Bank Threshold Settings	These fields are used to set the maximum, minimum, and fluctuation threshold settings for the Banks. These operate the same way as the Device Threshold Settings, above.

Groups

Outlet groups enable power configuration and control actions to be carried out on a selected group of outlets at the same time, rather than repeatedly performing the same action on each individual one. The *Groups* page lists the outlet groups that have already been configured, and shows which outlets are included in the group.

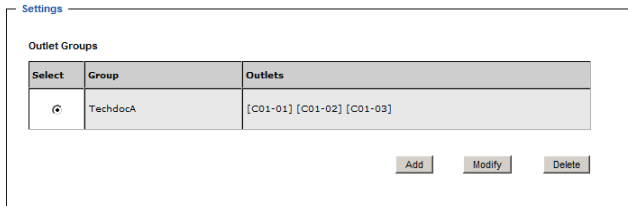

Note: In the Outlet column the outlets are displayed as [Station ID-Outlet Number]. For example, [C01-05] refers to outlet number 5 belonging to PN5212 / PN5320 station number 01.

This page is also used to create new outlet groups, as well as to modify or delete existing ones.

- ◆ To **Create** an outlet group, do the following:
 1. Click **Add**.
 2. In the page that comes up, first key in a name that will help you identify the group, then click the plus sign (+) in front of the device name to show the list of outlets.

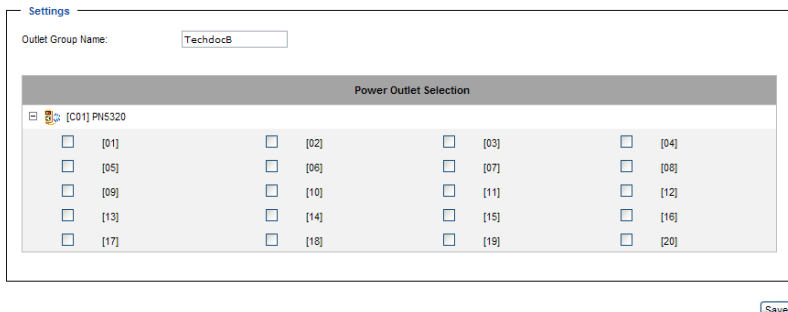

- Click to put a checkmark in the checkbox of the outlets you want to add to the group, then click **Save**.

When you return to the Group page, your new group is included in the list:

Settings

Outlet Groups

Select	Group	Outlets
<input checked="" type="checkbox"/>	TechdocA	[C01-01] [C01-02] [C01-03]
<input type="checkbox"/>	TechdocB	[C01-01] [C01-05]

Note: The group also shows up as a device in the Sidebar, and this page can be accessed by clicking on its icon in the Sidebar.

- To **Modify** an outlet group, select it in the list, then click **Modify**. The screen that comes up is the same one that appears when you click **Add**. You can rename the group as well as add and remove outlets. When you are done modifying the group click **Save**.
- To **Delete** an outlet group, select it in the list, then click **Delete**.

Outlet Level Configuration

The configuration settings for a PN5212 / PN5320 can be specified on an outlet by outlet basis. When an outlet is selected in the Configuration page Sidebar, the main panel displays a page with two tabs: *Configuration*, and *Schedule*, as described in the sections that follow.

Configuration

The *Configuration* tab page, similar to the one below, is the default that appears in the main panel.

The screenshot shows a web form titled "Configuration" with a sub-header "Port Settings". The form contains the following fields:

- Outlet Name:** A text input field containing "Outlet01".
- Confirmation Required:** A checkbox labeled "Enable" which is currently unchecked.
- Power ON Delay:** A text input field containing "5" followed by "sec".
- Power OFF Delay:** A text input field containing "1" followed by "sec".
- Shutdown Method:** A dropdown menu with "Kill the Power" selected.
- MAC Address:** A text input field that is currently empty.

A "Save" button is located at the bottom right of the form.

This page lets you set up the power management configuration for the selected outlet. The meanings of the field headings are given in the table on the following two pages:

Heading	Meaning
Outlet Name	Each outlet can be given a distinctive name. The maximum number of characters is 15.
Confirmation Required	If this option is enabled (there is a check in the checkbox), a dialog box comes up asking you to confirm a power operation before it is performed. If it is disabled (there is no check in the checkbox), the operation is performed without confirmation.
Power On Delay	<p>Sets the amount of time the PN5212 / PN5320 waits after the Power Button is clicked (see <i>Manual Power Management</i>, page 25), before it turns on the computer attached to the corresponding outlet.</p> <p>Note: The default delay time is 0 seconds; the maximum is 999 seconds. When a series of outlets are scheduled to be powered up, they turn on in sequence with a default delay of 10 milliseconds between each outlet.</p>

Heading	Meaning
Power Off Delay	<p>Sets the amount of time the PN5212 / PN5320 waits after the Power Button is clicked (see <i>Manual Power Management</i>, page 25), before it turns off the computer attached to the corresponding outlet.</p> <p>For the <i>System after AC Back</i> option (see below), after the delay time expires, the PN5212 / PN5320 waits another fifteen seconds, then shuts the computer down.</p> <p>The default delay time is 15 seconds. The maximum delay time is 999 seconds.</p>
Shutdown Method	<p>There are three choices for the Shutdown method. Drop down the list to select a choice. The meaning of each choice is described, below:</p> <p>Wake on LAN: This is a Safe Shutdown and Restart option. If this is selected, when an Outlet is turned Off, the PN5212 / PN5320 first sends a message to the computer telling it to prepare for a shutdown; it then waits for the amount time set in the <i>Power Off Delay field</i> to give the OS time to close down before the computer is powered down to standby mode.</p> <p>Likewise, when the Outlet is turned On, the PN5212 / PN5320 waits for the amount time set in the <i>Power On Delay field</i>, then sends an Ethernet message to the computer connected to the Outlet telling the computer to turn itself On.</p> <p>Note: For Safe Shutdown and Restart, the computer must be running Windows (Windows 98 or higher), and the <i>Safe Shutdown</i> program (available by download from our website), must be installed and running on the computer.</p> <p>System after AC Back: This is a Safe Shutdown and Restart option. If this is selected, when an Outlet is turned Off, the PN5212 / PN5320 first sends a message to the computer telling it to prepare for a shutdown; it then waits for the amount time set in the <i>Power Off Delay field</i> to give the OS time to close down before the computer is powered down.</p> <p>When the Outlet is turned On, the PN5212 / PN5320 waits for the amount time set in the <i>Power On Delay field</i>, then sends power to the server. When the server receives the power, it turns itself on.</p> <p>Note: For Safe Shutdown and Reboot, the computer must be running Windows (Windows 98 or higher), and the <i>Safe Shutdown</i> program (available by download from our website), must be installed and running on the computer.</p> <p>Kill the Power: If this option is selected, the PN5212 / PN5320 waits for the amount time set in the <i>Power Off Delay field</i>, and then turns the Outlet's power Off. Turning the power off performs a cold (non-safe) shutdown.</p>
MAC Address	<p>In order to use either of the Safe Shutdown and Restart methods the MAC address of the computer connected to the outlet must be filled in here.</p>
Server Diagnosis	<p>These fields are used to set up an ICMP ping command to check if the outlet is functioning properly. See <i>Server Diagnosis</i>, page 31 for a further explanation.</p>

When you have finished making your configuration settings, click **Save**.

Schedule

Clicking the *Schedule* tab brings up a page that lets you set up a scheduled power On/Off configuration for the selected outlet:

The screenshot shows a configuration form titled "Status". It contains the following fields and options:

- Routine Type:** A dropdown menu set to "Once".
- Week Day:** A dropdown menu set to "Sunday".
- Date:** A dropdown menu set to "1".
- Start Date:** A text input field with a calendar icon and a placeholder "(YYYY-MM-DD)".
- End Date:** A text input field with a calendar icon and a placeholder "(YYYY-MM-DD)".
- Shutdown Times:** Two text input fields for "(HH:MM)" and a "Disable" checkbox.
- Restart Time:** Two text input fields for "(HH:MM)" and a "Disable" checkbox.
- Every:** A text input field for "day(s)".

At the bottom right of the form is an "Add" button. Below the form is a table with the following columns: "Select", "Routine Type", "Start Date", "End Date", "Day", "Shutdown Time(HH:MM)", and "Restart Time(HH:MM)". A "Delete" button is located at the bottom right of the table.

The meanings of the field headings are given in the table, below:

Heading	Meaning
Routine Type	Drop down the list to select whether the scheduled power configuration should take place just Once, or on a Daily, Weekly, or Monthly basis.
Week Day	This field only becomes active if you choose <i>Weekly</i> as the routine type. If you choose Weekly, drop down the list to choose which day of the week you want the power management routine to take place on.
Date	This field only becomes active if you choose <i>Monthly</i> as the routine type. If you choose Monthly, drop down the list to choose which day of the month you want the power management routine to take place on.
Start Date	If you want to limit the power management routine to a particular time period, either click the calendar icon to select the date that the routine will start at, or key in a start date using the YYYY-MM-DD format
End Date	If you want to limit the power management routine to a particular time period, either click the calendar icon to select the date that the routine will end at, or key in an end date using the YYYY-MM-DD format
Shutdown Time	Key in the time of day you want the shutdown to take place using the HH:MM format. If you want to temporarily suspend this function without deleting the entry, click to put a check in the <i>Disable</i> checkbox at the right of this field. You can reinstate the function by unchecking the checkbox.

Heading	Meaning
Restart Time	Key in the time of day you want the restart to take place using the HH:MM format. If you want to temporarily suspend this function without deleting the entry, click to put a check in the <i>Disable</i> checkbox at the right of this field. You can reinstate the function by unchecking the checkbox.
Every	For added flexibility, you can use this field to refine the Daily, Weekly, and Monthly routines. For example, if you chose <i>Daily</i> as your routine type, you could have the routine take place every 3 days (instead of every day), by keying a 3 in this field.

After you have made your schedule settings, click **Add**. The schedule is summarized in the list at the bottom of the panel.

To remove the outlet's schedule, select it in the list and click **Delete**.

Chapter 6

User Management

Overview

When you select the *User Management* tab the screen comes up with *Accounts* selected in the Menu bar, and the *User List* displayed in the main panel:

The screenshot displays the ALTUSCN User Management interface. The top navigation bar includes tabs for Outlet Access, User Management (selected), Device Management, Log, Maintenance, and Download. The main content area shows a 'User List' table with columns for Select, Name, Type, and Account Status. A sidebar on the left lists various users, and a bottom status bar shows the user is logged in as 'administrator'.

Select	Name	Type	Account Status
<input checked="" type="checkbox"/>	administrator	Super Administrator	Active
<input type="checkbox"/>	marschang	Administrator	Active
<input type="checkbox"/>	davidlin	Administrator	Active
<input type="checkbox"/>	chrischan	Administrator	Active
<input type="checkbox"/>	rickchan	Administrator	Active
<input type="checkbox"/>	karthik	Administrator	Active
<input type="checkbox"/>	jeterhuang	Administrator	Inactive
<input type="checkbox"/>	rf111	Administrator	Active
<input type="checkbox"/>	cheeseng	Normal User	Active
<input type="checkbox"/>	albert	Administrator	Active
<input type="checkbox"/>	frosty	Normal User	Active
<input type="checkbox"/>	jonman	Normal User	Active

The Accounts page has two menu items: *Accounts*, for managing individual users; and *Groups*, for managing user groups.

Note: There is a pre-installed super administrator account. It can be used to set up the device and to begin creating users and groups. The Username for this account is *administrator*; the password is *password*. For security purposes, we strongly recommend changing these to something unique. See *Modifying User Accounts*, page 49 for details.

Users

Adding Users

To add a user, do the following:

1. Select *Users* in the Sidebar.
2. Click **Add** at the bottom of the User List in the main panel. The page opens with three tabs at the top: *User*, *Groups*, and *Devices*. The *User* tab is selected by default:

The screenshot shows the 'Add User' form with the following details:

- General:**
 - User Name:
 - Password:
 - Confirm Password:
- User Type:**
 - Super Admin
 - Admin
 - User
- Permissions:**
 - User Management
 - Maintenance
 - Select All
 - Device Management
 - Java Client
 - Log
- Status:**
 - Disable Account
 - Account never expires
 - Account expires on:
 - User must change password at next login
 - User cannot change password
 - Password never expires
 - Password Expires After: days

3. Enter the required information in the appropriate fields. A description of each of the fields is given in the table below:

Field	Description
Username	From 1 to16 characters are allowed depending on the Account Policy settings. See <i>Account Policy</i> , page 79.
Password	From 1 to16 characters are allowed depending on the Account Policy settings. See <i>Account Policy</i> , page 79.
Confirm Password	To be sure there is no mistake in the password, you are asked to enter it again. The two entries must match.
User Type	<p>There are three categories: Super Administrator, Administrator and User. There is no limitation on the number of accounts that can be created in each category.</p> <ul style="list-style-type: none"> ◆ The super administrator is responsible for the overall installation configuration and maintenance; user management; and device and outlet assignments. ◆ Administrators have User Management, Device Management, and Maintenance privileges, as well as being able to access specified devices and outlets. ◆ Users can access the devices and outlets assigned to them by the super administrator or administrator. Additional privileges can be assigned to them by the super administrator or administrator (see <i>Permissions</i>, below).
Permissions	<ul style="list-style-type: none"> ◆ Super administrators automatically have all permissions. ◆ Administrators automatically have User Management, Device Management, Java Client, and Maintenance permissions. They can be given additional permissions by checking the appropriate boxes. ◆ Ordinary users Java Client automatic privileges only. Their permissions are set individually by checking the appropriate boxes. <ul style="list-style-type: none"> ◆ Checking User Management, Device Management, Log, and/or Maintenance gives the user access to the respective tabs (on the tab bar), allowing the user to set and change the configuration parameters for the checked items. ◆ <i>Java Client</i> allows a user to access the Power Over the NET™ device with Java Client software in addition to (or instead of) the browser access method. ◆ <i>Modem</i> allows a user to access the Power Over the NET™ device using a modem connection.

Field	Description
Status	<p>Status allows you to control the user's account and access to the installation, as follows:</p> <ul style="list-style-type: none"> ◆ <i>Disable Account</i> lets you suspend a user's account without actually deleting it, so that it can be easily reinstated in the future. ◆ If you don't want to limit the time scope of the account, select <i>Account never expires</i>; if you want to limit the amount of time that the account remains in effect, select <i>Account expires on</i>, and key in the expiration date. ◆ To require a user to change his password at the next logon, select <i>User must change password at next logon</i>. This can be used by the administrator to give the user a temporary password to log in for the first time, and then let the user set the password of his choice for future logins. ◆ To make a password permanent, so that the user cannot change it to something else, select <i>User cannot change password</i>. ◆ For security purposes, administrators may want users to change their passwords from time to time. <ul style="list-style-type: none"> ◆ If not, select <i>Password never expires</i>. This allows users to keep their current passwords for as long as they like. ◆ If so, select <i>Password expires after</i>, and key in the number of days allowed before the password expires. Once the time is up, a new password must be set.

4. When your selections have been made click **Save**.
5. When the *Operation Succeeded* message appears, click **OK**.

You return to the main screen. The new user appears in the Sidebar *Users* tree and in the *User List* of the main panel.

The large main panel shows the user's name; the description that was given when the account was created; and whether the account is currently active or has been disabled.

Modifying User Accounts

To modify a user account, do the following:

1. In the Sidebar *User* tree, click the user's name
– or –

In the main panel, select the user's name, then click **Modify**.

2. In the *User* page that comes up is the same as the one for adding users (see page 46). Make your changes, then click **Save**.

Deleting User Accounts

To delete a user account do the following:

1. In the main panel, select the user's name, then click **Delete**.
2. Click **OK**.

Moving On

From here, we move on to the Groups menu entry. The Groups tab page that is part of the Accounts menu is discussed under *Users and Groups*, page 53. The Devices tab page is discussed under *Device Assignment*, page 57.

Groups

Groups allow administrators to easily and efficiently manage users and devices. Since device access rights apply to anyone who is a member of the group, administrators need only set them once for the group, instead of having to set them for each user individually. Multiple groups can be defined to allow some users access to specific devices, while restricting other users from accessing them.

Note: This section refers to the Groups menu. The Groups tab that appears when the Accounts menu item is selected, is discussed on page 53.

Creating Groups

To create a group, do the following:

1. Select *Groups* on the menu bar.
2. Select *User Groups* in the Sidebar.
3. Click **Add** at the bottom of the Group List in the main panel. The page opens with three tabs at the top: *Groups*, *Members*, and *Devices*. The *Groups* tab is selected by default:

The screenshot shows a web interface for creating a group. At the top, there are three tabs: "Groups", "Members", and "Devices". The "Groups" tab is selected. Below the tabs, the form is organized into three sections:

- General:** A text input field for "Group Name".
- Permissions:** A grid of checkboxes for various permissions: "User Management", "Device Management", "Log", "Maintenance", "Java Client" (checked), and "Modem".
- Status:** A grid of checkboxes for group status: "Disable Group", "Group never expires" (selected), and "Group expires on" with a date picker set to "2010-01-01".

A "Save" button is located at the bottom right of the form.

4. Enter the required information in the appropriate fields. A description of each of the fields is given in the table below:

Field	Description
Group Name	A maximum of 16 characters is allowed.
Permissions	<p>Group permissions are set by checking the appropriate boxes, as follows:</p> <ul style="list-style-type: none"> ◆ Checking User Management, Device Management, Log, and/or Maintenance gives all group members access to the respective tabs (on the tab bar), allowing the user to set and change the configuration parameters for the checked items. ◆ <i>Java Client</i> allows a user to access the Power Over the NET™ device with Java Client software in addition to (or instead of) the browser access method. ◆ <i>Modem</i> allows a user to access the Power Over the NET™ device using a modem connection.
Status	<ul style="list-style-type: none"> ◆ Checking Disable Group allows the administrator to suspend a group's authorization without having to delete the group. This way, the group can be easily reinstated without having to create it all over again – simply by unchecking the box. ◆ If administrators only want the group to exist for a certain period of time, they can click the <i>Group expires on</i> radio button and then specify and expiration date (YYYY-MM-DD). The default setting is <i>Group never expires</i>.

5. When your selections have been made click **Save**.
6. When the *Operation Succeeded* message appears, click **OK**.
- You return to the main screen. The new group appears in the Sidebar *User Groups* list and in the *Group List* of the main panel.

Modifying Groups

To modify a group, do the following:

1. In the Sidebar *Group* tree, click the group's name
– or –
In the main panel, select the group's name, then click **Modify**.
2. The *Groups* page that comes up is the same as the one for adding groups (see page 50). Make your changes, then click **Save**.

Deleting Groups

To delete a group do the following:

1. In the main panel, select the group's name, then click **Delete**.
2. Click **OK**.

Users and Groups

There are two ways to assign users to – and remove users from – groups: from the Accounts menu; and from the Groups menu.

Note: 1. Before you can assign users to groups, you must first create them.

See *Adding Users*, page 46 for details.

2. If a user has permissions in addition to the ones assigned to the group, the user keeps those permissions in addition to the group ones.

Assigning Users to a Group From the Accounts Page

To assign a user to a group from the Accounts page, do the following:

1. In the Sidebar *Users* tree, click the user's name

– or –

In the main panel, select the user's name, then click **Modify**.

2. In the page that comes up, select the *Groups* tab. A page similar to the one below appears:

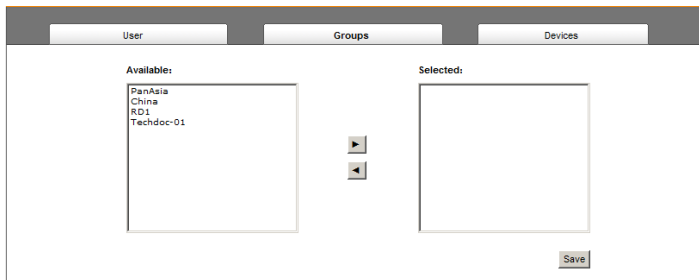

3. In the *Available* column, select the group that you want the user to be in.
4. Click the **Right Arrow** to put the group's name into the *Selected* column.
5. Repeat the above for any other groups that you want the user to be in.
6. Click **Save** when you are done.

Removing Users From a Group From the Accounts Page

To remove a user from a group from the Accounts page, do the following:

1. In the Sidebar *Users* tree, click the user's name
– or –
In the main panel, select the user's name, then click **Modify**.
2. In the page that comes up, select the *Groups* tab. A screen, similar to the one below, appears:

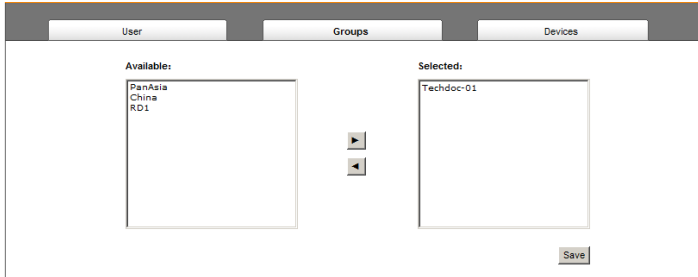

3. In the *Selected* column, select the group that you want to remove the user from.
4. Click the **Left Arrow** to remove the group's name from the *Selected* column. (It goes back into the *Available* column.)
5. Repeat the above for any other groups that you want to remove the user from.
6. Click **Save** when you are done.

Assigning Users to a Group From the Groups Page

To assign a user to a group from the Groups page, do the following:

1. In the Sidebar *User Groups* tree, click the group's name

– or –

In the main panel, select the group's name, then click **Modify**.

2. In the page that comes up, select the *Members* tab. A screen, similar to the one below, appears:

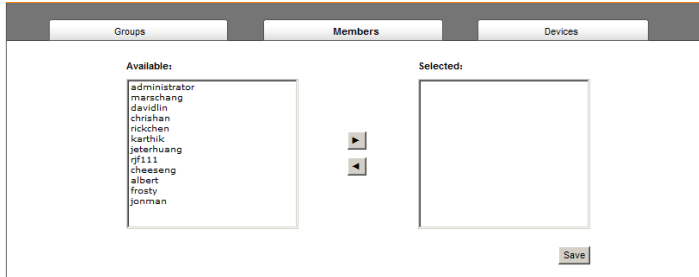

3. In the *Available* column, select the user that you want to be a member of the group.
4. Click the **Right Arrow** to put the user's name into the *Selected* column.
5. Repeat the above for any other users that you want to be members of the group.
6. Click **Save** when you are done.

Removing Users From a Group From the Groups Page

To remove a user from a group from the Groups page, do the following:

1. In the Sidebar *User Groups* tree, click the group's name
– or –
In the main panel, select the group's name, then click **Modify**.
2. In the page that comes up, select the *Members* tab. A screen, similar to the one below, appears:

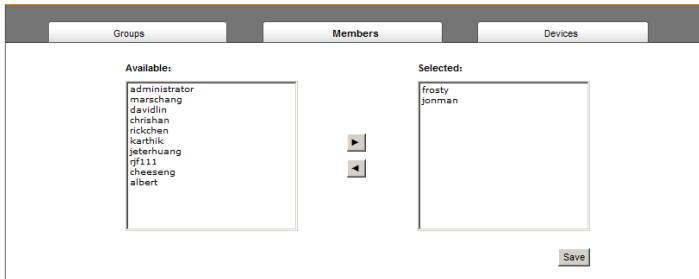

3. In the *Selected* column, select the user that you want to remove from the group.
4. Click the **Left Arrow** to remove the user's name from the *Selected* column. (It goes back into the *Available* column.)
5. Repeat the above for any other users that you want to remove from the group.
6. Click **Save** when you are done.

Device Assignment

When a user logs in to the Power Over the NET™ device, the interface comes up with the Outlet Access page displayed. All the outlets that the user is permitted to access are listed in the Sidebar at the left of the page. Access permissions for those outlets can be assigned on an outlet-by-outlet basis from the *Accounts* menu for individual users, or the *Groups* menu for user groups.

Assigning Device Permissions From the Accounts Menu

To assign device permissions to a user from the Accounts menu, do the following:

1. In the Sidebar *Users* tree, click the user's name
– or –

In the main panel, select the user's name, then click **Modify**.

2. In the that comes up, select the *Devices* tab. A screen, similar to the one below, appears:

The screenshot shows a web interface with three tabs: 'User', 'Groups', and 'Devices'. The 'Devices' tab is active. Below the tabs is a table with three columns: 'Outlets', 'Access', and 'Configuration'. The table lists 13 outlets, each with a checkbox in the 'Access' column and a checkbox in the 'Configuration' column. All checkboxes are checked. A 'Save' button is located at the bottom right of the table.

Outlets	Access	Configuration
[C01] PH5320		
[01] Outlet01	<input checked="" type="checkbox"/>	<input checked="" type="checkbox"/>
[02] Outlet02	<input checked="" type="checkbox"/>	<input checked="" type="checkbox"/>
[03]	<input checked="" type="checkbox"/>	<input checked="" type="checkbox"/>
[04]	<input checked="" type="checkbox"/>	<input checked="" type="checkbox"/>
[05]	<input checked="" type="checkbox"/>	<input checked="" type="checkbox"/>
[06]	<input checked="" type="checkbox"/>	<input checked="" type="checkbox"/>
[07]	<input checked="" type="checkbox"/>	<input checked="" type="checkbox"/>
[08]	<input checked="" type="checkbox"/>	<input checked="" type="checkbox"/>
[09]	<input checked="" type="checkbox"/>	<input checked="" type="checkbox"/>
[10]	<input checked="" type="checkbox"/>	<input checked="" type="checkbox"/>
[11]	<input checked="" type="checkbox"/>	<input checked="" type="checkbox"/>
[12]	<input checked="" type="checkbox"/>	<input checked="" type="checkbox"/>

Note: The page comes up with the outlets nested under the devices. Click the plus sign in front of a device's name to show the outlets.

- ◆ Outlets are listed in the left hand column. Permissions can be set on an outlet-by-outlet basis.
- ◆ The *Access* column is where device access rights are set.
- ◆ The *Configuration* column enables/disables a user from making configuration changes to the outlet settings.

3. Under the *Access* column, click to permit or restrict the user's access to an outlet. A check mark (✓) indicates that the user has permission to access the outlet; a blank checkbox means that the user is denied permission to access the outlet.
4. Under the *Configuration* column, click to permit or restrict the user's ability to change the outlet's configuration settings. A check mark (✓) indicates that the user has permission to make changes to the outlet's configuration settings (see Chapter 7, *Device Management*); a blank checkbox means that the user is denied permission to make changes to the outlet's configuration settings.
5. In the confirmation popup that appears, click **OK**.

Assigning Device Permissions From the Groups Page

To assign device permissions to a Group of users, do the following:

1. In the Sidebar *User Groups* tree, click the group's name
– or –
In the main panel, select the group's name, then click **Modify**.
2. In the *page* that comes up, select the *Devices* tab.
3. The screen that comes up is the same one that appears when assigning permissions from the Accounts page. Make your device assignments according to the information described under *Assigning Device Permissions From the Accounts Menu*, page 57.
The only difference is that whatever settings you make apply to all members of the group instead of just one individual member.

Chapter 7

Device Management

Overview

The *Device Management* page allows super administrators, administrators, and users with device management permission to configure and control overall Power Over the NET™ device operations.

Device Information

When you click the **Device Management** tab, the display opens with the *Device Information* menu page displayed:

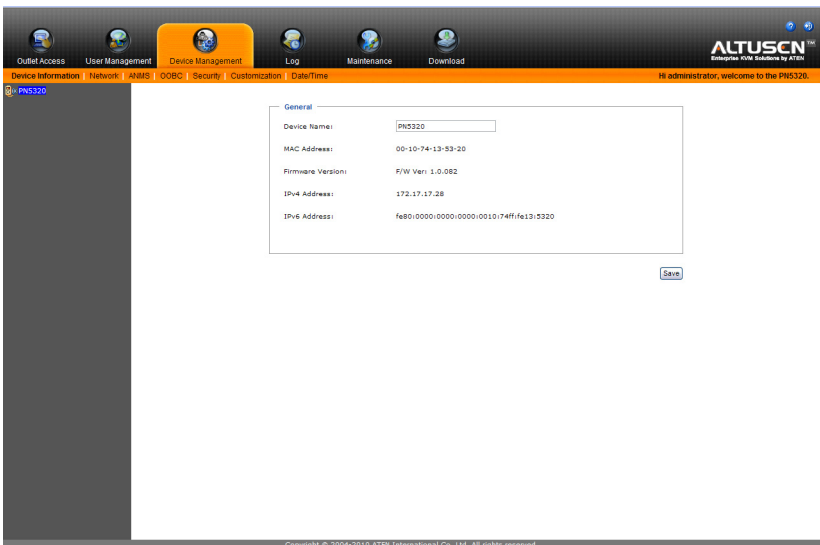

The page presents information about the selected device, as described in the following table.

Item	Meaning
Device Name	This field lets you give the device a unique name. This can be convenient when you need to differentiate among several devices in multi station installations. Simply delete whatever is in the text box and key in the name of your choice. Click Save to save the new name.
MAC Address	This item displays the Power Over the NET™ device's MAC address.
Firmware Version	This item displays the current firmware version number. You can reference it to see if there are newer versions available on the ALTUSEN website.
IPv4 Address	This item displays the IP address of the device's network interface in the traditional format.
IPv6 Address	This item displays the IP address of the device's network interface in the new format.

Network

The Network page is used to specify the Power Over the NET™ device's network environment. The main section is divided into 5 panels. Select the device you want to configure in the Sidebar, then fill in the information in the panels according to the information given in the sections that follow.

When you have finished making all of your configuration settings, click **Save** (at the bottom of the page).

Service Ports

As a security measure, if a firewall is being used, the Administrator can specify the port numbers that the firewall will allow. If a port other than the default is used, users must specify the port number as part of the IP address when they log in. If an invalid port number (or no port number) is specified, the Power Over the NET™ device will not be found.

Service Ports

HTTP:

HTTPS:

An explanation of the fields is given in the table below:

Field	Explanation
HTTP	The port number for a browser login. The default is 80.
HTTPS	The port number for a secure browser login. The default is 443.

- Note:**
- Valid entries for all of the Service Ports are from 1–65535.
 - The service ports cannot have the same value. You must set a different value for each one.
 - If there is no firewall (on an Intranet, for example), it doesn't matter what these numbers are set to, since they have no effect.

Settings

This field specifies the time interval for the browser page to automatically refresh and display the latest power information.



The screenshot shows a settings panel with a blue header labeled "Settings". Below the header, there is a label "Web Refresh Rate:" followed by a text input field containing the number "60" and the unit "sec(s)".

IP Installer

The IP Installer is an external Windows-based utility for assigning IP addresses to the Power Over the NET™ device.

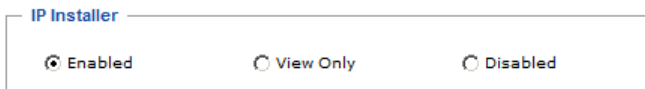

The screenshot shows a panel with a blue header labeled "IP Installer". Below the header, there are three radio button options: "Enabled" (which is selected), "View Only", and "Disabled".

Click one of the radio buttons to select *Enable*, *View Only*, or *Disable* for the IP Installer utility. See *Method 1:*, page 122, for IP Installer details.

-
- Note:** 1. If you select *View Only*, you will be able to see the Power Over the NET™ device in the IP Installer's Device List, but you will not be able to change the IP address.
2. For security, we strongly recommend that you set this to *View Only* or *Disable* after use.
-

IPv4 Configuration

The device's IPv4 IP and DNS addresses (the traditional method of specifying IP addresses) can either be assigned dynamically (DHCP), or a fixed IP address can be specified.

IPv4 Configuration

Obtain IP address automatically [DHCP]

Set IP address manually [Fixed IP]

IP Address:

Subnet Mask:

Default Gateway:

Obtain DNS server address automatically

Set DNS server address manually

Preferred DNS server:

Alternate DNS server:

- ◆ For dynamic IP address assignment, select the *Obtain IP address automatically* radio button. (This is the default setting.)
- ◆ To specify a fixed IP address, select the *Set IP address manually* radio button and fill in the IP address with values appropriate for your network.
- ◆ For automatic DNS Server address assignment, select the *Obtain DNS Server address automatically* radio button.
- ◆ To specify the DNS Server address manually, select the *Set DNS server address manually* radio button, and fill in the addresses for the Preferred and Alternate DNS servers with values appropriate for your network.

-
- Note:**
1. If you choose *Obtain IP address automatically*, when the device starts up it waits to get its IP address from the DHCP server. If it hasn't obtained the address after one minute, it automatically reverts to its factory default IP address (192.168.0.60.)
 2. If the device is on a network that uses DHCP to assign network addresses, and you need to ascertain its IP address, see *IP Address Determination*, page 122, for information.
 3. Specifying the Alternate DNS Server address is optional.
-

IPv6 Configuration

The device's IPv6 IP and DNS addresses (the new method of specifying IP addresses) can either be assigned dynamically, or a fixed IP address can be specified.

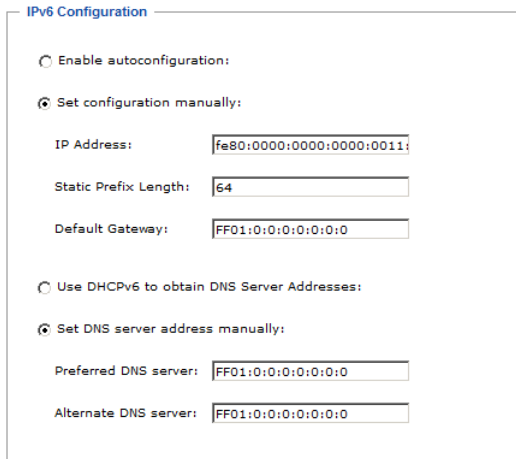

The screenshot shows the 'IPv6 Configuration' window. It has two main sections. The first section is for IP configuration, with 'Set configuration manually' selected. It contains three input fields: 'IP Address' with the value 'fe80:0000:0000:0000:0011', 'Static Prefix Length' with '64', and 'Default Gateway' with 'FF01:0:0:0:0:0:0:0'. The second section is for DNS configuration, with 'Set DNS server address manually' selected. It contains two input fields: 'Preferred DNS server' and 'Alternate DNS server', both with the value 'FF01:0:0:0:0:0:0:0'.

- ◆ For dynamic IP address assignment, select the *Enable Autoconfiguration* radio button. (This is the default setting.)
- ◆ To specify a fixed IP address, select the *Set configuration manually* radio button and fill in the *IP address*, *Static Prefix Length*, and *Default Gateway* fields with values appropriate for your network.
- ◆ For automatic DNS Server address assignment, select the *Use DHCPv6 to obtain DNS Server Addresses* radio button.
- ◆ To specify the DNS Server address manually, select the *Set DNS server address manually* radio button, and fill in the addresses for the Preferred and Alternate DNS servers with values appropriate for your network.

Note: Specifying the Alternate DNS Server address is optional.

ANMS

The ANMS (Advanced Network Management Settings) page is used to set up event notifications, login authentication and authorization management from external sources, and CC Management. It is organized in three tabbed pages: Event Notification; Authentication & Authorization; and CC Management. These pages are explained in the sections that follow

Event Notification

When you select ANMS on the menu bar, the GUI displays the *Event Notification* tab's page. The page is divided into 4 sections: SMTP Settings; Log Server; SNMP Trap Receivers; and Syslog Server. Each section is described below.

SMTP Settings

SMTP Settings

Enable report from the following SMTP Server

SMTP Server:

My server requires authentication

Account Name:

Password:

From:

To:

To have the Power Over the NET™ device email reports from the SMTP server to you, do the following:

1. Enable the *Enable report from the following SMTP server*, and key in the IP address of your SMTP server.
2. If your server requires authentication, put a check in the *My server requires authentication* checkbox.
3. Key in the appropriate account information in the *Account Name*, *Password*, and *From* field.

Note: Only one email address is allowed in the *From* field, and it cannot exceed 64 Bytes. (1 Byte = 1 English alphanumeric character.)

4. Key in the email address (addresses) of where you want the event reports sent to in the *To* field.

Note: If you are sending the report to more than one email address, separate the addresses with a semicolon. The total cannot exceed 256 Bytes.

Log Server

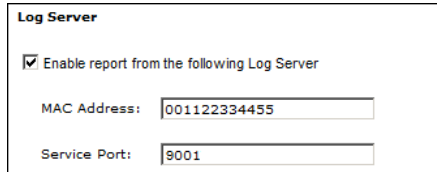

The screenshot shows a dialog box titled "Log Server". It contains a checked checkbox labeled "Enable report from the following Log Server". Below this are two input fields: "MAC Address:" with the value "001122334455" and "Service Port:" with the value "9001".

Important transactions that occur on the Power Over the NET™ device, such as logins and internal status messages, are automatically generated and kept by an ATEN *Log Server* program. Specify the MAC address of the computer that the Log Server resides on, and the service port number used. The valid port range is 1-65535. The default port number is 9001.

-
- Note:**
1. Make sure that the port number you specify here matches the one you specify in the Log Server's configuration settings (see *Configure*, page 99).
 2. The port number must be different than the one used for the *Program* port (see *Service Ports*, page 61).
-

Installation and operation of the Log Server is discussed in Chapter 10. The Log File is discussed on page 85.

SNMP Trap Receivers

SNMP Trap Receiver

Enable SNMP Trap

Receiver 1 IP:

Service Port 1:

Community 1:

Up to four SNMP management stations can be specified. If you want to use SNMP trap notifications, do the following:

1. Check *Enable SNMP Trap*.
2. Key in the IP address(es) and the service port number(s) of the computer(s) to be notified of SNMP trap events. The valid port range is 1–65535. The default port number is 192.

Note: Make sure that the port number you specify here matches the port number used by the SNMP receiver computer.

3. Key in the Community name(s) that correspond to each of the stations.

Syslog Server

Syslog Server

Enable

Server IP:

Service Port:

To record all the events that take place on Power Over the NET™ devices and write them to the PN5212 / PN5320 Syslog server, do the following:

1. Check **Enable**.
2. Key in the IP address and the port number of the Syslog server. The valid port range is 1-65535. The default port number is 514.

Finishing Up

When you have finished making your settings on this page, click **Save**.

Authentication & Authorization

The Authentication & Authorization page is used to set up login authentication and authorization management from external sources.

Disable Local Authentication

Selecting this option will disable login authentication locally on the Power Over the NET™ device. The device can only be accessed using LDAP, LDAPS, MS Active Directory, RADIUS, TACACS+, or CC Management authentication.

RADIUS Settings

RADIUS Settings

Enable

Preferred RADIUS Server IP:

Preferred RADIUS Service Port:

Alternate RADIUS Server IP:

Alternate RADIUS Service Port:

Timeout: sec

Retries:

Shared Secret (at least 6 characters):

To allow authentication and authorization for the Power Over the NET™ device through a RADIUS server, do the following:

1. Check **Enable**.
2. Fill in the IP addresses and service port numbers for the Preferred and Alternate RADIUS servers. The default port number for the Preferred server is 1812; the default port number for the Alternate server is 1645.

Note: Make sure that the port numbers you specify here match the port numbers used by the RADIUS servers.

3. In the *Timeout* field, set the time in seconds that the Power Over the NET™ device waits for a RADIUS server reply before it times out.

4. In the *Retries* field, set the number of allowed retries for attempting to connect to the RADIUS server.
5. In the *Shared Secret* field, key in the character string that you want to use for authentication between the Power Over the NET™ device and the RADIUS Server.
6. On the RADIUS server, set the entry for each user as follows:

su/xxxx

Where *xxxx* represents the Username given to the user when the account was created on the Power Over the NET™ device. The user's access rights are the ones assigned for the Power Over the NET™ device, as well. (See *Adding Users*, page 46.)

LDAP/AD Settings

LDAP/AD Settings	
<input type="checkbox"/> Enable	
<input checked="" type="checkbox"/> Enable SSL	
Preferred LDAP Server IP:	192.168.0.100
Preferred LDAP Service Port:	389
Preferred LDAP SSL Service Port:	636
Alternate LDAP Server IP:	192.168.0.101
Alternate LDAP Service Port:	389
Alternate LDAP SSL Service Port:	636
Timeout:	3
Admin DN:	ou=users,dc=aten,dc=com
Admin Name:	LDAPadmin
Password:	password
Search DN:	dc=aten,dc=com

To allow authentication and authorization for the Power Over the NET™ device through an LDAP/AD server, refer to the information in the table, below:

Item	Action
Enable	Put a check in the <i>Enable</i> checkbox to allow LDAP authentication and authorization.
Enable SSL	Put a check in the <i>Enable SSL</i> checkbox to specify an SSL connection.
Preferred/Alternate LDAP Server IP	Fill in the IP address for the preferred/alternate LDAP server. The default port number is 389; for LDAPS, the default port number is 636.
Preferred/Alternate LDAP Service Port	Fill in the port number for the preferred/alternate LDAP server. The default port number is 389.
Preferred/Alternate LDAP SSL Service Port	Fill in the SSL port number for the preferred/alternate LDAP server. The default port number is 636.
Timeout	Set the time in seconds that the Power Over the NET™ device waits for an LDAP server reply before it times out.
Admin DN	Consult the LDAP / LDAPS administrator to ascertain the appropriate entry for this field. For example, the entry might look like this: <code>ou=kn4132,dc=aten,dc=com</code>
Admin Name	Key in the LDAP administrator's username.
Password	Key in the LDAP administrator's password.
Search DN	Set the distinguished name of the search base. This is the domain name where the search starts for user names.

Note: If LDAP is enabled, the LDAP schema for MS Active Directory must be extended. For detailed LDAP configuration instructions please download the *LDAP Help File* from the right column of the PN5212 / PN5320's product page on our website. www.aten.com

TACACS+

TACACS+

Enable

Preferred TACACS+ Server IP:

Preferred TACACS+ Service Port:

Alternate TACACS+ Server IP:

Alternate TACACS+ Service Port:

Shared Secret (at least 6 characters):

To allow authentication and authorization for the Power Over the NET™ device through a TACACS+ server, do the following:

1. Check **Enable**.
2. Fill in the IP addresses and port numbers for the Preferred and Alternate TACACS+ servers. The default port number is 49.

Note: Make sure that the port numbers you specify here match the port numbers used by the TACACS+ servers.

3. In the *Shared Secret* field, key in the character string that you want to use for authentication between the Power Over the NET™ device and the TACACS+ Server.

Finishing Up

When you have finished making your settings on this page, click **Save**.

CC Management

This page allows you to manage authentication and authorization for the Power Over the NET™ device through a CC (Control Center) server. If this is enabled, users will be able to access the device via their CC session.

CC Management

Enable

CC Server IP

CC Service Port

To allow authentication and authorization for the Power Over the NET™ device through a CC (Control Center) server, check *Enable* and fill in the CC Server's IP address and the port that it listens on in the appropriate fields.

When you have finished making your settings on this page, click **Save**.

SNMP Agent

If you want to use SNMP to help with your installation management:

1. Check *Enable*.
2. Once SNMP Agent has been enabled, the *SNMP Agent Service Port* field becomes active. Enter the port number here.
3. Key in passwords for the *Community Name* fields. We recommend replacing the defaults (public, private) with an alphanumeric string of at least 8 characters.
4. When you have finished making all your entries, click *Save*, to save them.



SNMP Agent

Enable

SNMP Agent Service Port:

Read-only community:

Read-Write community:

Save

Note: MIB definitions for the PN5212 / PN5320 are provided on the CD that came with the package, or can be downloaded from the ATEN website.

OoBC

In case the LAN that the Power Over the NET™ device resides on goes down, or the it cannot be accessed with the usual browser based method for some other reason, the device can be accessed via an *Out of Band* method utilizing its Console.

The OoBC page is used to set up the serial configuration parameters for serial terminal *Out of Band* access to the Power Over the NET™ device, as described in the section that follows.

- ◆ To operate the PN5212 / PN5320 from a local computer's console terminal (HyperTerminal, GTKTerminal, etc.), connect the PN5212 / PN5320's *Console* port to the COM port of a local computer (see *Single Stage Installation*, page 11, and *Console Terminal Session*, page 105).

Console Port Settings

For serial terminal operation, this section sets the serial parameters of the Power Over the NET™ device's Console port.

The screenshot shows a dialog box titled "Console Port Settings" with five rows of configuration options, each with a label and a dropdown menu:

- Baud Rate: 38400 bps
- Data Bits: 8
- Stop Bits: 1
- Parity: None
- Flow Control: None

Note: The Console port's serial parameters and the parameters of the device it connects to must both be the same.

Security

The Security page controls access to the Power Over the NET™ device.

Security

Login String:

IP Filter Enable: Include Exclude

MAC Filter Enable: Include Exclude

Account Policy

Minimum Username Length:

Minimum Password Length:

Password Must Contain At Least:

- One Upper Case
- One Lower Case
- One Number

Disable Duplicate Login

Private Certificate

Private Key:

Certificate:

Login String

The *Login String* entry field is used to specify a login string (in addition to the IP address) that users must include when accessing the Power Over the NET™ device with a browser. For example:

```
192.168.0.126/abcdefgh
```

- ♦ The following characters are allowed:
0–9 a–z A–Z ~ ! @ \$ ^ & * () _ + ' - = [] { } ; ' < > , . |
- ♦ The following characters are not allowed:
 - ♦ % ” : / ? # \ [Space]
 - ♦ Compound characters (É Ç ñ ... etc.)

Note: 1. There must be a forward slash between the IP address and the string.
2. If no login string is specified here, anyone will be able to access the Power Over the NET™ device login page using the IP address alone. This makes your installation less secure.

For security purposes, we recommend that you change this string occasionally.

IP and MAC Filtering

If any filters have been configured, they appear in the IP Filter and/or MAC Filter list boxes.

IP and MAC Filters control access to the Power Over the NET™ device based on the IP and/or MAC addresses of the client computers attempting to connect. A maximum of 100 IP filters and 100 MAC filters are allowed.

To enable IP and/or MAC filtering, click to put a check mark in the *IP Filter Enable* and/or *MAC Filter Enable* checkbox.

- ♦ If the include button is checked, all the addresses within the filter range are allowed access; all other addresses are denied access.
- ♦ If the exclude button is checked, all the addresses within the filter range are denied access; all other addresses are allowed access.

Adding Filters

To add an IP filter, do the following:

1. Click **Add**. A dialog box similar to the one below appears:

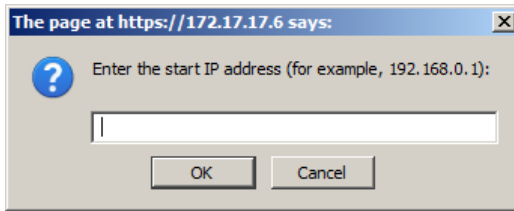

2. Specify the filter address in the dialog box (for example, 192.168.0.200), then click **OK**.

A second dialog box, similar to the one below, appears:

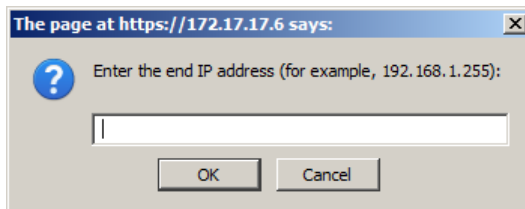

3. To filter a single IP address, key in the same address as the start IP. To filter a continuous range of addresses, key in the end number of the range (for example, 192.168.0.225).
4. After filling in the address, click **OK**.

Repeat these steps for any additional IP addresses you want to filter.

To add a MAC filter, do the following:

1. Click **Add**. A dialog box similar to the one below appears:

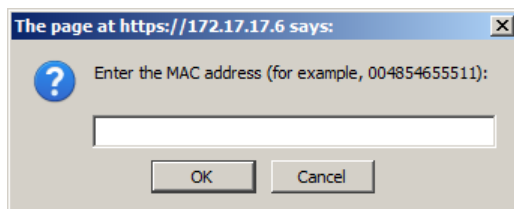

- Specify the MAC address in the dialog box (for example, 001074670000), then click **OK**.

Repeat these steps for any additional MAC addresses you want to filter.

IP Filter / MAC Filter Conflict

If there is a conflict between an IP filter and a MAC filter – for example, where a computer’s IP address is allowed by the IP filter but it’s MAC address is excluded by the MAC filter – then that computer’s access is blocked.

In other words, if either filter blocks a computer, then the computer is blocked, no matter what the other filter is set to.

Modifying Filters

To modify a filter, select it in the IP Filter or MAC Filter list box and click **Modify**. The Modify dialog box is similar to the Add dialog box. When it comes up, simply delete the old address(es) and replace it with the new one(s).

Deleting Filters

To delete a filter, select it in the IP Filter or MAC Filter list box and click **Delete**.

Account Policy

The Account Policy section governs policies in regard to usernames and passwords. Check a policy and enter the required information in the appropriate fields.

Item	Description
Minimum Username Length	Sets the minimum number of characters required for a username. Acceptable values are from 1–16.
Minimum Password Length	Sets the minimum number of characters required for a password. Acceptable values are from 1–16.
Password Must Contain At Least	Checking any of these items requires users to include at least one of the specified items in their password. Note: This policy does not affect existing user accounts. Only new user accounts created after this policy has been enabled, and users required to change their passwords are affected.
Disable Duplicate Login	Check this to prevent users from logging in with the same account at the same time.

Private Certificate

When logging in over a secure (SSL) connection, a signed certificate is used to verify that the user is logging in to the intended site. For enhanced security, the *Private Certificate* section allows you to use your own private encryption key and signed certificate, rather than the default ATEN certificate.

There are two methods for establishing your private certificate: generating a self-signed certificate; and importing a third-party certificate authority (CA) signed certificate.

Generating a Self-Signed Certificate

If you wish to create your own self-signed certificate, a free utility – openssl.exe – is available for download over the web. See *Self-Signed Private Certificates*, page 128 for details about using OpenSSL to generate your own private key and SSL certificate.

Obtaining a CA Signed SSL Server Certificate

For the greatest security, we recommend using a third party certificate authority (CA) signed certificate. To obtain a third party signed certificate, go to a CA (Certificate Authority) website to apply for an SSL certificate. After the CA sends you the certificate and private encryption key, save them to a convenient location on your computer.

Importing the Private Certificate

To import the private certificate, do the following:

1. Click **Browse** to the right of *Private Key*; browse to where your private encryption key file is located; and select it.
2. Click **Browse** to the right of *Certificate*; browse to where your certificate file is located; and select it.
3. Click **Upload** to complete the procedure.

Note: 1. Clicking **Restore Default** returns the device to using the default ATEN certificate.

2. Both the private encryption key and the signed certificate must be imported at the same time.

When you have finished making your settings on this page, click **Save**.

Customization

The *Customization* page is used to set *Login Failure* and *Working Mode* parameters.

The screenshot shows two sections of a web interface. The first section, titled "Login Failures", contains two input fields: "Allowed:" with a text box containing the number "0", and "Timeout:" with a text box containing "0" followed by "min". The second section, titled "Working Mode", contains three checked checkboxes: "Enable ICMP", "Enable Browser", and "Enable Multiuser Operation".

Login Failures

- ◆ **Allowed** sets the number of consecutive failed login attempts that are permitted from a remote user.
- ◆ **Timeout** sets the amount of time a remote user must wait before attempting to login again after exceeding the number of allowed failures.

Working Mode

- ◆ If *ICMP* is **enabled**, the Power Over the NET™ device can be pinged. If it is not enabled, the device cannot be pinged. The default is Enabled.
- ◆ To permit browser access to the Power Over the NET™ device, click to put a check mark in the *Enable Browser* checkbox. If browser access is not enabled, users must use the Java Client AP program to access the switch. The default is Enabled.
- ◆ Enabling *Multiuser operation* permits up to 32 users to log in at the same time to share the remote bus. If not enabled, only one user can log in at a time. The default is Enabled.

When you have finished making your settings on this page, click **Save**.

Date/Time

The Date/Time dialog page sets the Power Over the NET™ device time parameters:

Time Zone

(GMT+08:00) Taipei

Daylight Savings Time

Manual Input

Date: 2010-06-08 (YYYY-MM-DD)

Time: 06:32:01 (HH:MM:SS)

Sync with PC

Network Time

Enable auto adjustment

Preferred time server

AU | ntp1.cs.mu.OZ.AU

Preferred custom server IP 10.3.52.84

Alternate time server

AU | ntp1.cs.mu.OZ.AU

Alternate custom server IP 0.0.0.0

Adjust time every 1 days

[Adjust Time Now](#)

Set the parameters according to the information below.

Time Zone

- ◆ To establish the time zone that the Power Over the NET™ device is located in, drop down the *Time Zone* list and choose the city that most closely corresponds to where it is at.
- ◆ If your country or region employs Daylight Saving Time (Summer Time), check the corresponding checkbox.

Manual Input

Use this section to specify the Power Over the NET™ device's date and time manually.

- ◆ Click the calendar icon and click the calendar entry for the date.
- ◆ Key the time into the Time field, using the HH:MM:SS (hours, minutes, seconds) format.

Note: This section is only enabled when *auto adjustment* (in the *Network Time* section) is disabled (the checkbox is unchecked).

As an alternative to specifying the date and time by entering them into the date and time fields, you can click to put a check in the *Sync with PC* checkbox, in which case the Power Over the NET™ device will take its date and time settings from the locally connected PC.

Network Time

To have the time automatically synchronized to a network time server, do the following:

1. Check the *Enable auto adjustment* checkbox.
2. Drop down the time server list to select your preferred time server
– or –
Check the *Preferred custom server IP* checkbox, and key in the IP address of the time server of your choice.
3. If you want to configure an alternate time server, check the *Alternate time server* checkbox, and repeat step 2 for the alternate time server entries.
4. Key in your choice for the number of days between synchronization procedures.

Finishing Up

When you have finished making your settings on this page, click **Save**.

After you have saved your changes, if you want to synchronize immediately, click **Adjust Time Now**.

This Page Intentionally Left Blank

Chapter 8

Log

Overview

The PN5212 / PN5320 keeps an extensive record of all the transactions that take place on its installation. The *Log* page provides a powerful array of filters and functions that allow you to view and export the log file data, as well as be informed by email of specified events as they occur.

System Log

When you click the **Log** tab, the display opens with the *System Log* menu page, which looks similar to the one below:









The screenshot displays the ALTUSCN web interface. At the top, there is a navigation bar with icons for 'Outlet Access', 'User Management', 'Device Management', 'Log' (highlighted), 'Maintenance', and 'Download'. The 'ALTUSCN' logo is in the top right corner. Below the navigation bar, the page title is 'System Log' and the user is identified as 'H administrator, welcome to the PN5320'. A 'Refresh' button and '25 Events per Page' are visible. The main content area contains a table of log entries:

0014	2000-01-01 01:18:04	Device	Information	administrator	OFF command issued to station 1 - Outlet 3 by administrator.
0015	2000-01-01 01:18:00	Device	Information	administrator	OFF command issued to station 1 - Outlet 2 by administrator.
0016	2000-01-01 01:17:55	Device	Information	administrator	Off command issued to station 1 - Outlet 1 by administrator.
0017	2000-01-01 01:16:47	Authentication	Information	administrator	administrator 10.0.13.236 logged in.
0018	2000-01-01 00:03:49	Authentication	Information	administrator	administrator 10.0.13.236 logged out.
0019	2000-01-01 00:01:49	Authentication	Information	administrator	administrator 10.0.13.236 logged in.
0020	2000-01-01 00:23:13	Device	Information	administrator	Station 1 device was rebooted.
0021	2000-01-01 00:23:07	System	Notice	administrator	Firmware upgrade on station 1 by administrator was successful.
0022	2000-01-01 00:23:07	System	Information	administrator	Event log settings were modified by administrator.

At the bottom of the interface, there are buttons for 'Clear', 'Search', and social media icons (Facebook, Twitter, LinkedIn, YouTube, RSS). The footer contains the copyright notice: 'Copyright © 2004-2010 ATEN International Co., Ltd. All rights reserved.'

The Log Event List

- Clicking on a device in the Sidebar displays its log events in the main panel's log event list.
- Clicking the **Refresh** button brings the log list up to date with the latest events.
- The entry box to the right of the Refresh button lets you set the number of events to display per page. Simply key in the number of your choice.
- The top right of the main panel shows the total number of pages in the log file, and what page you are currently viewing.
- The icons in the row just below the log event list are explained in the table, below:



Icon	Function
	Clear: Click to erase the contents of the log event list.
	Search: Click to bring up a dialog box with search parameters that let you refine the display to items that fall within the parameters you choose. See <i>Search</i> , page 87 for details.
	Click to go to the first page of the log event list.
	Click to move to the previous page of the log event list.
	Click to move to the next page of the log event list.
	Click to move to the last page of the log event list.
	Click to save the contents of the log event list to file. See <i>Save</i> , page 88 for details.
	Click to print the contents of the log event list.



Search

Search allows you to search for events according to selected criteria, such as: specific words, users, date, time, severity, and category. You can also search on any combination of criteria to refine the search even further. When you click the Search icon, a *Search* panel, similar to the one below, appears:

Search

Keyword: From:  To: 

User:

Severity		Category	
<input checked="" type="checkbox"/> Critical	<input checked="" type="checkbox"/> Errors	<input checked="" type="checkbox"/> System	<input checked="" type="checkbox"/> Authentication
<input checked="" type="checkbox"/> Warning	<input checked="" type="checkbox"/> Notice	<input checked="" type="checkbox"/> User management	<input checked="" type="checkbox"/> Device
<input checked="" type="checkbox"/> Information			

- ◆ To search on a keyword, key it into the *Keyword* text box.
- ◆ To search for a user, click the arrow at the right of the *User* entry box and make your selection from the drop down list.
- ◆ To search by date, click on the calendar icons to the right of the *From* and *To* fields and click on the appropriate dates. To search on a single day, pick the same day for both fields.
- ◆ To search by time drop down the lists for hours and seconds in the *From* and *To* fields and click on the appropriate figures.
- ◆ By default, all the *Severity* and *Category* items are checked and will be included in the search criteria. To deselect an item, click on its checkbox.
- ◆ To return the panel to its default settings (all entry fields blank or zero; all Server and Category items checked) click **Reset**.
- ◆ To begin the search, click **Submit**.
- ◆ To dismiss this panel, click the Search icon again.



Save

Save allows you to save the contents of the event log list (or the results of a Search), to a file. When you click the Save icon, similar to the one below appears:

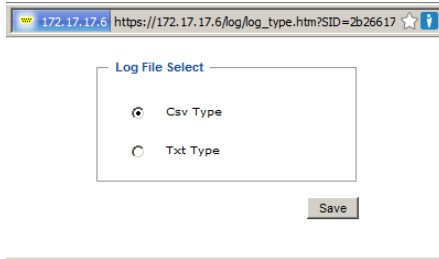

To save specified logged events to a file, do the following:

1. Click one of the radio buttons to specify the file format you want to save the file in (csv files can be read by a spreadsheet program).
2. Click **Save**.

After a moment, a dialog box similar to the one below, comes up:

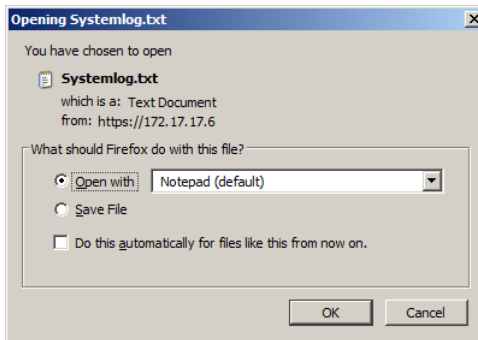

3. Select *Save File*, then click **OK**.

Notification Settings

The Notification Settings page is used to specify which of the PN5212 / PN5320's components will receive notification of a log event. When you click the Notification Settings menu item, a page similar to the one below appears:

Event Log Setting Save

Event List						
Event	Aten Log server	SNMP	Syslog	EEmail	Digital output	
▾ Enable all System events	<input type="checkbox"/>	<input type="checkbox"/>	<input type="checkbox"/>	<input type="checkbox"/>	<input type="checkbox"/>	
▾ Enable all Authentication events	<input type="checkbox"/>	<input type="checkbox"/>	<input type="checkbox"/>	<input type="checkbox"/>	<input type="checkbox"/>	
User login	<input type="checkbox"/>	<input type="checkbox"/>	<input type="checkbox"/>	<input type="checkbox"/>	<input type="checkbox"/>	
User login failure	<input type="checkbox"/>	<input type="checkbox"/>	<input type="checkbox"/>	<input type="checkbox"/>	<input type="checkbox"/>	
User logout	<input type="checkbox"/>	<input type="checkbox"/>	<input type="checkbox"/>	<input type="checkbox"/>	<input type="checkbox"/>	
Session timeout	<input type="checkbox"/>	<input type="checkbox"/>	<input type="checkbox"/>	<input type="checkbox"/>	<input type="checkbox"/>	
▾ Enable all User Management events	<input type="checkbox"/>	<input type="checkbox"/>	<input type="checkbox"/>	<input type="checkbox"/>	<input type="checkbox"/>	
▾ Enable all Device Management events	<input type="checkbox"/>	<input type="checkbox"/>	<input type="checkbox"/>	<input type="checkbox"/>	<input type="checkbox"/>	

- ◆ The event categories are listed in the left column.
 - ◆ When you first open the page, only the main category items appear. (Main category item rows have a gray background.)
 - ◆ Sub-category items are nested under the main category headings. Click the arrow in front of the main category headings to display the sub-category items. (Sub-category item rows have a white background.)
- ◆ Click the checkboxes under the column headings to select which component(s) will receive notification of the log events.
 - ◆ Clicking on a main category heading's row automatically selects all the sub-category items nested below it.
 - ◆ If you only want to set notification for some of the sub-category events, don't put a check in the main category row. Instead, drop down the sub-category list, and only check the sub-category events you want.
- ◆ When you have finished making your setting choices, click **Save**. When a specified log event occurs, notification of that event will be sent to the selected component.
- ◆ Reset Digital Output: If an event has been triggered that changes the digital output sensor from Low to High, click this button to return the sensor to the Low state.

This Page Intentionally Left Blank

Chapter 9

Maintenance and Download

Overview

The *Maintenance* function is used to upgrade the PN5212 / PN5320's firmware, and to backup and restore the device's configuration settings. *Download* is used to download a stand-alone Java Client AP program to access the PN5212 / PN5320.

Maintenance

Firmware Upgrade

When you click the **Maintenance** tab, the display opens with the *Firmware Upgrade* menu page, which looks similar to the one below:

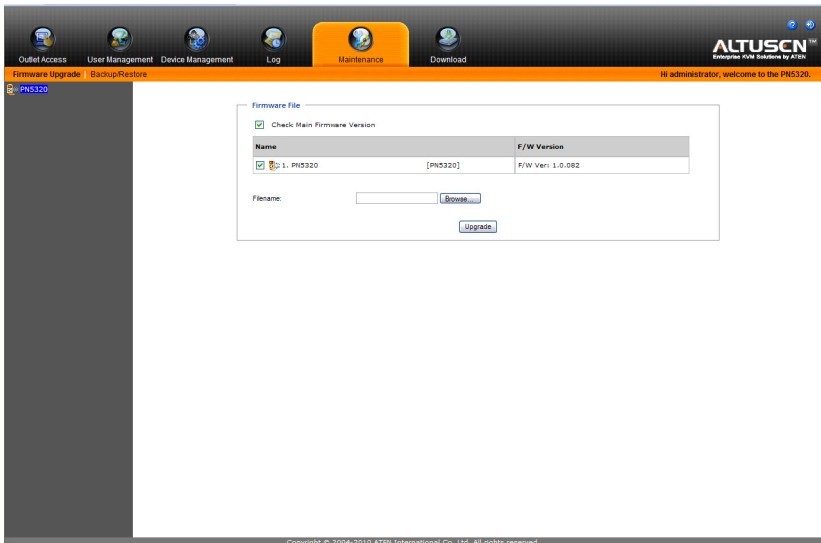

The Main Panel

A description of the items shown in this panel are given in the table, below:

Item	Description
Check Main Firmware Version	If you enable <i>Check Main Firmware Version</i> , the PN5212 / PN5320's current firmware level is compared with that of the upgrade file. If the current version is equal to or higher than the upgrade version, a popup message appears, to inform you of the situation and stops the upgrade procedure.
Name	Lists all of the PN5212 / PN5320 devices. Click to put a check in the checkbox of the device's whose firmware you want to upgrade.
F/W Version	Displays the PN5212 / PN5320's current firmware version.
Filename	As new versions of the firmware become available, they are posted on our website and can be downloaded to a convenient location on your computer. Click the <i>Browse</i> button to select the downloaded upgrade file.
Upgrade	Click this button to upgrade the firmware of the selected devices.

Upgrading the Firmware

To upgrade the firmware refer to the screenshot on the preceding page, and do the following:

1. Go to our website and download the new firmware file to a convenient location on your computer.
2. Click the *Browse* button; navigate to where the firmware file is located and select it.
3. Click **Upgrade** to start the upgrade procedure.
 - ◆ If you enabled *Check Main Firmware Version* the current firmware level is compared with that of the upgrade file. If the current version is equal to or higher than the upgrade version, a popup message appears, to inform you of the situation and stops the upgrade procedure.
 - ◆ If you didn't enable *Check Main Firmware Version*, the upgrade file is installed without checking what its level is.
 - ◆ Once the upgrade completes successfully, the switch resets itself.
4. Log in again, and check the firmware version to be sure it is the new one.

Firmware Upgrade Recovery

Should the PN5212 / PN5320's firmware upgrade procedure fail, and the device becomes unusable, the following firmware upgrade recovery procedure will resolve the problem:

1. Power off the device.
2. Press and hold the Reset Switch in (see page 7).
3. While holding the Reset Switch in, power the switch back on.

This causes the switch to use the original factory installed main firmware version. Once the switch is operational, you can try upgrading the main firmware again.

Backup/Restore

Selecting *Backup/Restore* on the menu bar gives you the ability to back up the switch's configuration and user profile information:

The image shows a web interface for Backup/Restore operations. It is divided into two main sections: Backup and Restore.

Backup Section:

- Label: Backup
- Field: Password: [text input]
- Button: Save

Restore Section:

- Label: Restore
- Field: Password: [text input]
- Field: Filename: [text input] with a Browse... button
- Section: Options (containing several checkboxes):
 - Device Information
 - Network
 - ANMS
 - OOB
 - Security
 - Customization
 - Date/Time
 - Accounts/Groups
 - Select All
- Button: Restore

Backup

To backup the device's settings do the following:

1. In the *Password* field, key in a password for the file.

Note: Entering a password is optional. If you do enter a password, make a note of it, since you will need it to be able to restore the file.

2. Click **Save**.
3. When the browser asks what you want to do with the file, select *Save to disk*; then save it in a convenient location.

Restore

To restore a previous backup, do the following:

1. Click **Browse**; navigate to the file and select it.

Note: If you renamed the file, you can leave the new name. There is no need to return it to its original name.

2. In the *Password* field, key in the same password that you used to save the file.

Note: If you did not set a password when you created the backup file, you can omit this step.

3. Select as many of the options that are presented as you wish to restore.
4. Click **Restore**.

After the file is restored, a message appears to inform you that the procedure succeeded.

Download

Download is used to download a stand-alone Java Client AP version of the PN5212 / PN5320 software. When you click the Download tab, the browser brings up a dialog box asking what you want to do with the program file:

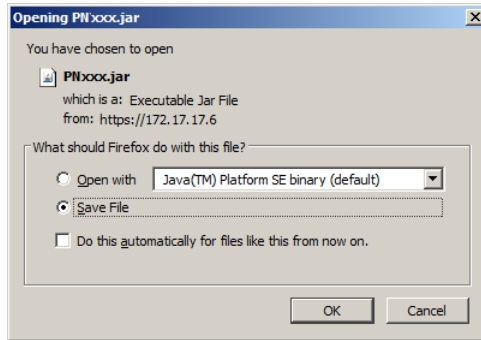

The Java Client AP can be run via a console terminal connection from your computer's COM port to the PN5212 / PN5320's Console Port.

This Page Intentionally Left Blank

Chapter 10

The Log Server

The Windows-based Log Server is an administrative utility that records all the events that take place on selected Power Over the NET™ devices and writes them to a searchable database. This chapter describes how to install and configure the Log Server.

Installation

The *Log Server AP Installer* is provided on the CD that came with your Power Over the NET™ device. To install the Log Server, do the following:

1. On the computer you want to use as the Log Server, put the CD into its CD (DVD) drive.
2. Navigate to the *Log Server AP Installer* folder on the CD.
3. Click the *Log Server* icon to start the installation. A screen, similar to the one below, appears:

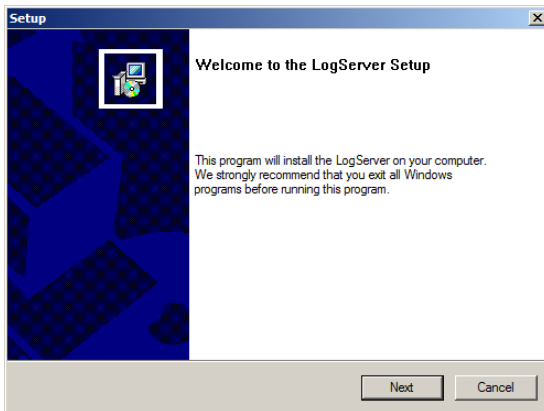

4. Click **Next**. Then follow the on-screen instructions to complete the installation and have the Log Server program icon placed on your desktop.

Starting Up

To start the Log Server, either double click the program icon, or key in the full path to the program on the command line. The first time you run it, a screen similar to the one below appears:

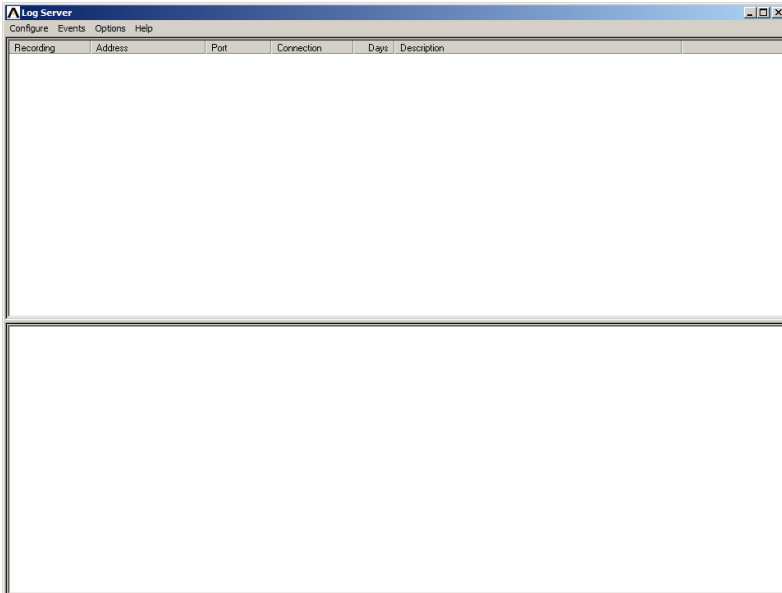

-
- Note:**
1. The MAC address of the Log Server computer must be specified under the *ANMS* settings – see *Log Server*, page 66 for details.
 2. The Log Server requires the Microsoft Jet OLEDB 4.0 driver. See *The Log Server program does not run.*, page 132 if the program doesn't start.
-

The screen is divided into three components:

- ♦ A *Menu Bar* at the top
- ♦ A panel that will contain a list of Power Over the NET™ units in the middle (see *The Log Server Main Screen*, page 103).
- ♦ A panel that will contain an *Events List* at the bottom

Each of the components is explained in the sections that follow.

The Menu Bar

The Menu bar consists of four items:

- ◆ Configure
- ◆ Events
- ◆ Options
- ◆ Help

These are discussed in the sections that follow.

Note: If the Menu Bar appears to be disabled, click in the List window to enable it.

Configure

The Configure menu contains three items: Add; Edit; and Delete. They are used to add new units to the List; edit the information for units already on the list; or delete units from the list.

- ◆ To add a unit to the list, click **Add**.
- ◆ To edit or delete a listed unit, first select the target in the List window, then open this menu and click **Edit** or **Delete**.

When you choose *Add* or *Edit*, a dialog box, similar to the one below, appears:

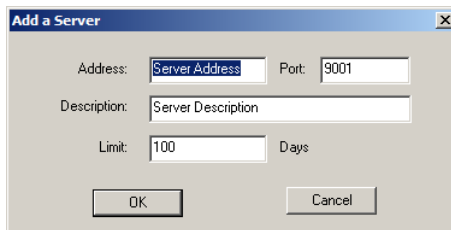

The screenshot shows a dialog box titled "Add a Server". It has a standard Windows-style title bar with a close button (X). The dialog contains the following fields and controls:

- Address:** A text box containing "Server Address".
- Port:** A text box containing "9001".
- Description:** A larger text box containing "Server Description".
- Limit:** A text box containing "100", followed by the label "Days".
- Buttons:** "OK" and "Cancel" buttons at the bottom.

A description of the fields is given in the table, below:

Field	Explanation
Address	This can either be the IP address of the unit or its DNS name (if the network administrator has assigned it a DNS name).
Port	The port number that was assigned to the Log Server (see <i>Log Server</i> , page 66).
Description	This field is provided so that you can put in a descriptive reference for the unit to help identify it.
Limit	This specifies the number of days that an event should be kept in the Log Server's database. Events that exceed the amount of time specified here can be removed with the Maintenance function (see <i>Maintenance.</i> , page 101).

Fill in or modify the fields, then click **OK** to finish.

Events

The Events Menu has two items: *Search* and *Maintenance*.

Search:

Search allows you to search for events containing specific words or strings. When you access this function, a screen, similar to the one below, appears:

The screenshot shows a 'Search Dialog' window with the following components:

- Search Options:** Three radio buttons: 'New search' (selected), 'Search last results', and 'Search excluding last results'.
- Server List:** A text box containing '10.0.13.233'.
- Priority List:** A text box containing 'Least', 'Less', and 'Most'.
- Search Criteria:** Fields for 'Start date' (2009/11/16), 'Start time' (13:55:19), 'End date' (2009/11/17), 'End time' (13:55:19), and 'Pattern' (empty).
- Result:** A list of search results for server 10.0.13.233, including events like 'User administrator changes to [03]9120 CN8 to .14', 'User administrator from 00-19-DB-EA-8C-C5 10.0.13.178 attempting to login', 'User at 00-19-DB-EA-8C-C5 10.0.13.178 logged out', 'Sys: Connected to 10.0.13.178 (00-19-DB-EA-8C-C5)', 'User administrator (IP = 10.0.13.178) attempting to login.', 'Access via Java client (IP = 10.0.13.178)', 'Sys: Disconnected from 10.0.13.178 (00-19-DB-EA-8C-C5)', 'User (IP = 10.0.13.178) logged out.', 'Sys: Connected to 10.0.13.178 (00-19-DB-EA-8C-C5)', and 'User administrator (IP = 10.0.13.178) attempting to login.'.
- Buttons:** 'Search', 'Print', 'Export', and 'Exit'.

A description of the items is given in the table, below:

Item	Description
New search	This is one of three radio buttons that define the scope of the search. If it is selected, the search is performed on all the events in the database for the selected unit.
Search last results	This is a secondary search performed on the events that resulted from the previous search.
Search excluding last results	This is a secondary search performed on all the events in the database for the selected unit excluding the events that resulted from the previous search.
Server List	Power Over the NET™ units are listed according to their IP address. Select the unit that you want to perform the search on from this list. You can select more than one unit for the search. If no units are selected, the search is performed on all of them.
Priority	Sets the level for how detailed the search results display should be. <i>Least</i> is the most general; <i>Most</i> is the most specific. Least results appear in black; Less results appear in blue; Most results appear in red.
Start Date	Select the date that you want the search to start from. The format follows the YYYY/MM/DD convention, as follows: 2009/11/04
Start Time	Select the time that you want the search to start from. The format follows the HH:MM:SS convention.
End Date	Select the date that you want the search to end at.
End Time	Select the time that you want the search to end at.
Pattern	Key in the pattern that you are searching for here. The multiple character wildcard (%) is supported. E.g., h%ds would match hands and hoods.
Results	Lists the events that contained matches for the search.
Search	Click this button to start the search.
Print	Click this button to print the search results.
Export	Click this button to save the search results to file.
Exit	Click this button to exit the Log Server.

Maintenance:

This function allows the administrator to perform manual maintenance of the database, such as erasing specified records before their expiration time is up.

Options

Network Retry allows you to set the number of seconds that the Log Server should wait before attempting to connect if its previous attempt to connect failed. When you click this item, a dialog box, similar to the one below, appears:

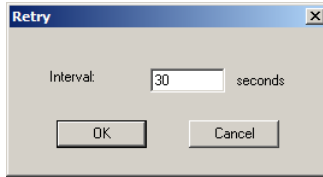

Key in the number of seconds, then click **OK** to finish.

Help

From the Help menu, click Contents to access the online Windows Help file. The help file contains instructions about how to setup, operation and troubleshoot the Log Server.

The Log Server Main Screen

Overview

The Log Server Main Screen is divided into two main panels.

- ◆ The upper (List) panel lists all of the units that have been selected for the Log Server to track (see *Configure*, page 99).
- ◆ The lower (Event) panel displays the tick information for the currently selected unit. (If there are more than one unit, the selected unit is the one that is highlighted).
- ◆ To select a unit in the list, simply click on it.

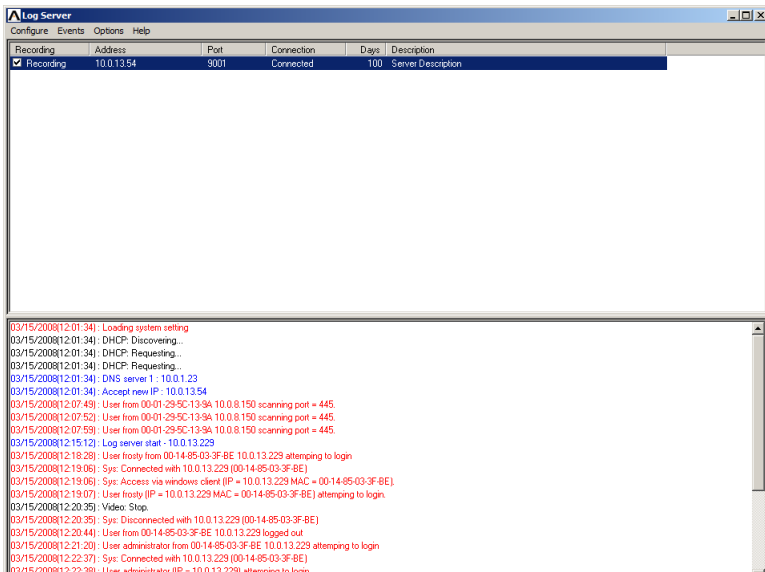

The List Panel

The List panel contains six fields:

Field	Explanation
Recording	Determines whether the Log Server records the ticks for this unit, or not. If the Recording checkbox is checked, the field displays <i>Recording</i> , and the ticks are recorded. If the Recording checkbox is not checked, the field displays <i>Paused</i> , and the ticks are not recorded. Note: Even though a unit is not the currently selected one, if its Recording checkbox is checked, the Log Server will still record its ticks.
Address	This is the IP Address or DNS name that was given to the unit when it was added to the Log Server (see <i>Configure</i> , page 99).
Port	This is the Access Port number assigned to the unit (see <i>Configure</i> , page 99).
Connection	<ul style="list-style-type: none">◆ If the Log Server is connected to the unit, this field displays <i>Connected</i>.◆ If the Log Server is not connected, this field displays <i>Waiting</i>. This means that the Log Server's MAC address has not been set properly. It needs to be set on the <i>Device Management Date/Time</i> page (see page 82).
Days	This field displays the number of days that the unit's log events are to be kept in the Log Server's database before expiration (see <i>Configure</i> , page 99).
Description	This field displays the descriptive information given for the unit when it was added to the Log Server (see <i>Configure</i> , page 99).

The Event Panel

The lower panel displays log events for the currently selected unit. Note that if the installation contains more than one unit, even though a unit isn't currently selected, if its *Recording* checkbox is checked, the Log Server records its log events and keeps them in its database.

Chapter 11

Out of Band Operation

Overview

In case the LAN that the PN5212 / PN5320 resides on goes down, or the PN5212 / PN5320 cannot be accessed with the usual browser based method for some other reason, the PN5212 / PN5320 can be accessed via an *Out of Band* method utilizing the PN5212 / PN5320's Console port in the following way:

- ◆ For a *console terminal session*, connect the PN5212 / PN5320's Console port (see *PON In / Console Port*, page 8), to the COM port of a local computer. You can then operate the PN5212 / PN5320 from the local computer's console terminal (HyperTerminal, GTKTerminal, etc.).

Console Terminal Session

This section describes how to establish a console terminal session using HyperTerminal as an example, as follows:

1. Use Cat 5e cable to connect the PN5212 / PN5320's *PON IN/Console* port to the SA0151 (DTE) adapter supplied with your package. Connect the adapter to the COM port of the computer you will use for the console terminal.

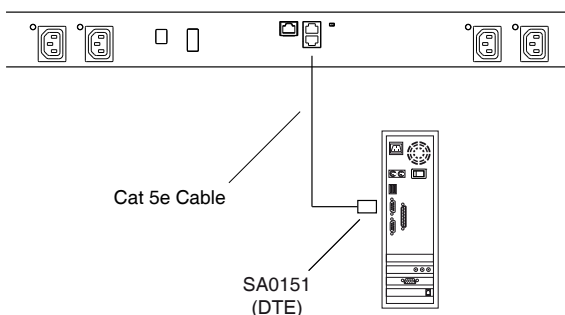

2. On your local computer, run the HyperTerminal program:
3. When a dialog box, similar to the one below appears, key in a name to describe the connection in the *Name* field, select an icon to represent the connection; then click **OK**.

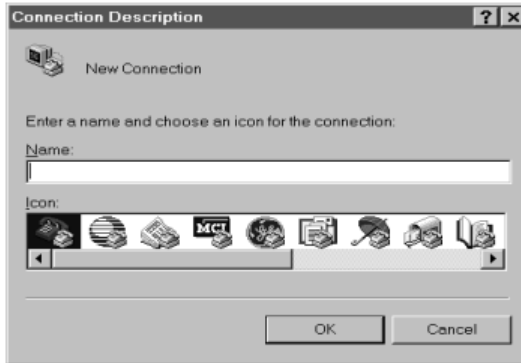

Note: In the examples we used *Com1Test* for the Name, and *COM1* for the computer's COM port. If you use a different COM port, change the settings accordingly.

The following dialog box comes up:

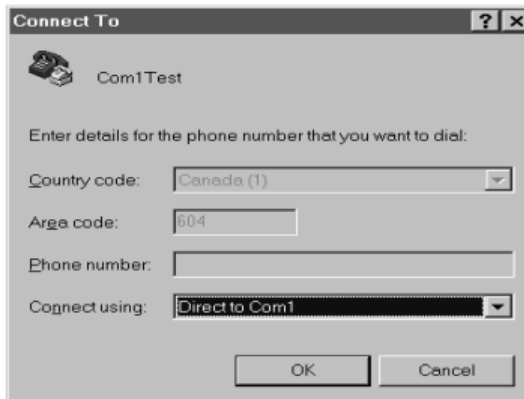

- For the *Connect using:* field, select *Direct to COM1* (assuming you are using COM1 on your computer), then click **OK**. A *Port Setting* dialog box similar to the one below comes up:

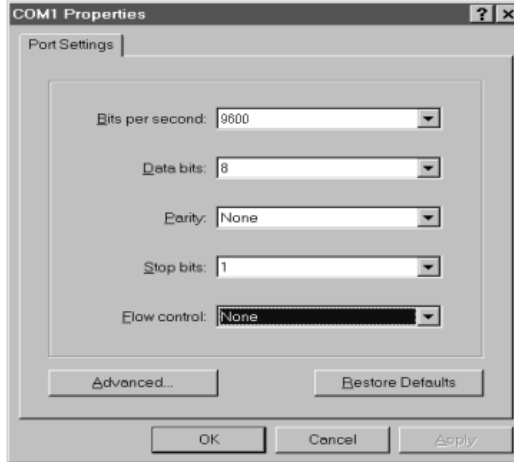

- Fill in the settings so that they match the ones you specified for the PN5212 / PN5320's console port settings on the *OOBC* page (see *Console Port Settings*, page 75), then click **OK**.
- When the HyperTerminal screen appears, open its File menu and select: Properties → Settings. A dialog box, similar to the one below, displays:

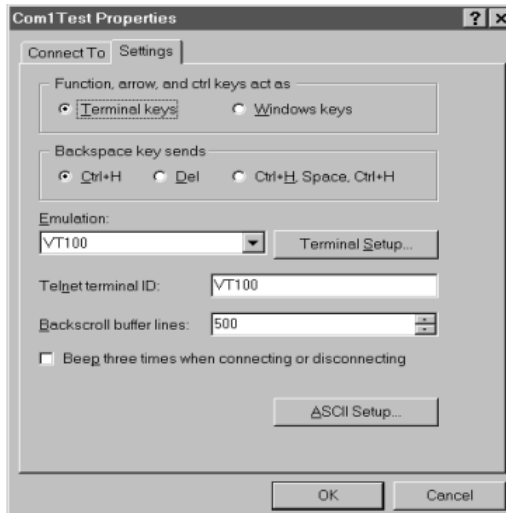

7. Change your settings (if necessary), so that they match the settings shown in the diagram, then click **ASCII Setup...**
8. In the ASCII Setup dialog box that comes up, change the settings (if necessary), so that they match the settings shown in the diagram below, then click **OK**.

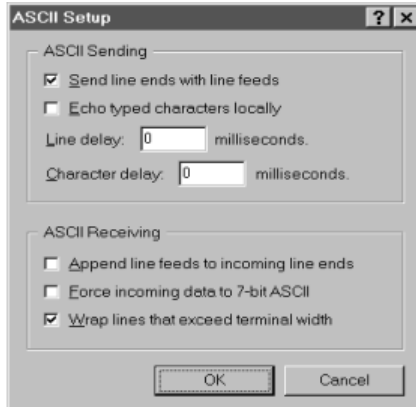

9. Close the HyperTerminal window. When Windows asks if you want to disconnect, click **Yes**. When Windows asks if you want to save the session, click **Yes**.

This completes the HyperTerminal setup. For Windows NT, 2000, XP and Windows Server 2003 systems, a HyperTerminal icon that connects you to the PN5212 / PN5320 is created on the desktop. For Windows 98 and ME, you must access HyperTerminal from the Windows Start Menu.

Logging In

1. Double click the HyperTerminal icon on your desktop.
2. In the VT100 terminal window, key in:
???
A login prompt appears.
3. Key in your Username and Password to bring up the PN5212 / PN5320's text-based configuration menu. The text-based configuration menu is discussed on page 110.

Chapter 12

Remote Terminal Operation

Overview

The PN5212 / PN5320 can be accessed via a remote terminal session using several methods, including Telnet, SSH, or PuTTY, as described in the sections that follow.

Telnet

Logging In

To log in to the PN5212 / PN5320 by means of a Telnet session, do the following:

1. On your computer, open a terminal (command line) session.
2. At the prompt, key in the PN5212 / PN5320's IP Address in the following way:

```
telnet [IP Address]
```

3. Press **Enter**.

The login screen appears:

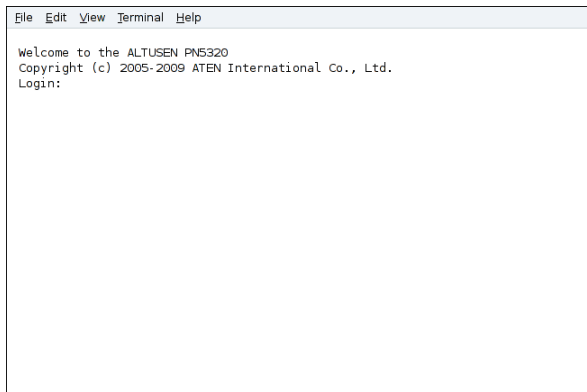

4. At the login prompt, provide your Username and Password.

Once a Telnet connection to the device is established, the PN5212 / PN5320's text-based Configuration Menu comes up:

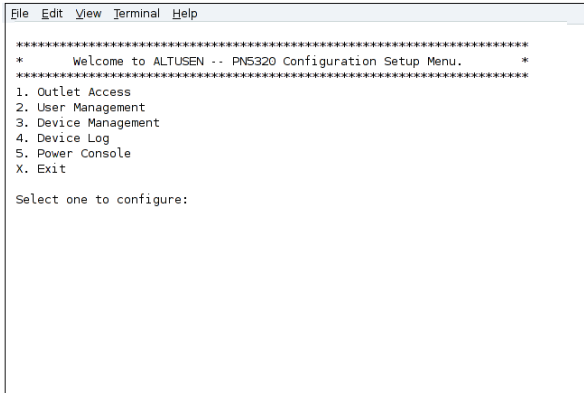
A screenshot of a terminal window showing the configuration menu. The window title is "File Edit View Terminal Help". The content is as follows:

```
*****
*       Welcome to ALTUSEN -- PN5320 Configuration Setup Menu.       *
*****
1. Outlet Access
2. User Management
3. Device Management
4. Device Log
5. Power Console
X. Exit

Select one to configure:
```

The text-based Configuration Menu provides text-based equivalents for the functions found under the web-based tabs and menus. You can reference the information provided for the browser version as you work your way through the submenus.

Note: As with the browser version, access to many of these submenus are restricted to the administrator or users with administration permission. If you select a submenu that you are not authorized for, nothing will happen.

When you have finished with your session, bring up the Main Menu and press **X** to log out. After you are offline, you can simply close the terminal (command line) window.

SSH

Terminal Session (Linux):

To log in to the PN5212 / PN5320 by means of a secure SSH session, do the following:

1. Open a terminal (command line) on your computer.
2. At the prompt, key in your PN5212 / PN5320 Username and the PN5212 / PN5320's IP Address in the following way:

```
ssh [username@IP Address]
```

3. Press **Enter**
4. When you are prompted for a password, use your PN5212 / PN5320 password.

Once an SSH connection to the device is established, the PN5212 / PN5320's text-based Configuration Menu comes up:

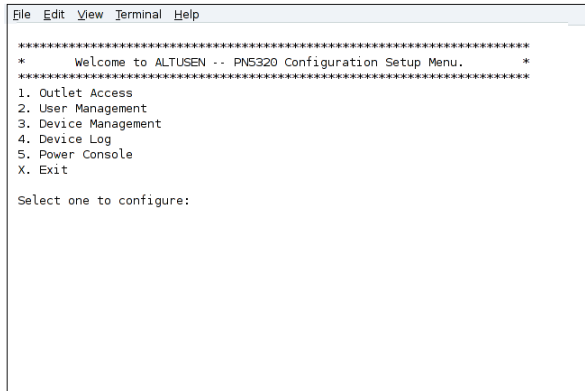

```
File Edit View Terminal Help
*****
* Welcome to ALTUSEN -- PN5320 Configuration Setup Menu. *
*****
1. Outlet Access
2. User Management
3. Device Management
4. Device Log
5. Power Console
X. Exit

Select one to configure:
```

This menu is the same as the configuration menu that appears with Telnet sessions (see page 110). It provides text-based equivalents for the functions found under the web-based tabs and menus. You can reference the information provided for the browser version as you work your way through the submenus.

Third Party Utility (Windows):

SSH sessions can be implemented under Windows with the use of third party utility software, such as PuTTY, a free implementation of Telnet and SSH for the Win32 and Unix platforms. To make an SSH connection with PuTTY, do the following:

1. In the *Host Name* box, enter the Internet host name or IP Address of the server you want to connect to.

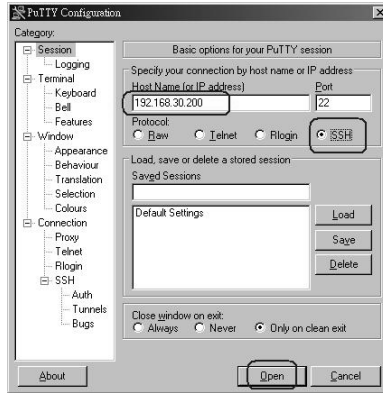

2. Select *SSH* from the Protocol buttons.
3. Click **Open** (at the bottom of the dialog box)
4. After you have connected, provide your PN5212 / PN5320 username and password at the login prompts.

Note: If you make a mistake keying in the username, the SSH protocol doesn't allow you to try again. You must close PuTTY and start over.

Once an SSH connection to the device is established, the PN5212 / PN5320's text-based Configuration Menu comes up. This menu is the same as the configuration menu that appears with Telnet sessions (see page 110).

Safety Instructions

General

- ◆ This product is for indoor use only.
- ◆ Read all of these instructions. Save them for future reference.
- ◆ Follow all warnings and instructions marked on the device.
- ◆ Do not place the device on any unstable surface (cart, stand, table, etc.). If the device falls, serious damage will result.
- ◆ Do not use the device near water.
- ◆ Do not place the device near, or over, radiators or heat registers.
- ◆ The device cabinet is provided with slots and openings to allow for adequate ventilation. To ensure reliable operation, and to protect against overheating, these openings must never be blocked or covered.
- ◆ The device should never be placed on a soft surface (bed, sofa, rug, etc.) as this will block its ventilation openings. Likewise, the device should not be placed in a built in enclosure unless adequate ventilation has been provided.
- ◆ Never spill liquid of any kind on the device.
- ◆ Unplug the device from the wall outlet before cleaning. Do not use liquid or aerosol cleaners. Use a damp cloth for cleaning.
- ◆ The device should be operated from the type of power source indicated on the marking label. If you are not sure of the type of power available, consult your dealer or local power company.
- ◆ To prevent damage to your installation it is important that all devices are properly grounded.
- ◆ The device is equipped with a 3-wire grounding type plug. This is a safety feature. If you are unable to insert the plug into the outlet, contact your electrician to replace your obsolete outlet. Do not attempt to defeat the purpose of the grounding-type plug. Always follow your local/national wiring codes.
- ◆ The socket-outlet should be installed near the equipment and should be easily accessible.
- ◆ Do not allow anything to rest on the power cord or cables. Route the power cord and cables so that they cannot be stepped on or tripped over.

- ◆ To help protect your system from sudden, transient increases and decreases in electrical power, use a surge suppressor, line conditioner, or uninterruptible power supply (UPS).
- ◆ Position system cables and power cables carefully; Be sure that nothing rests on any cables.
- ◆ When connecting or disconnecting power to hot pluggable power supplies, observe the following guidelines:
 - ◆ Install the power supply before connecting the power cable to the power supply.
 - ◆ Unplug the power cable before removing the power supply.
 - ◆ If the system has multiple sources of power, disconnect power from the system by unplugging all power cables from the power supplies.
- ◆ Never push objects of any kind into or through cabinet slots. They may touch dangerous voltage points or short out parts resulting in a risk of fire or electrical shock.
- ◆ Do not attempt to service the device yourself. Refer all servicing to qualified service personnel.
- ◆ If the following conditions occur, unplug the device from the wall outlet and bring it to qualified service personnel for repair.
 - ◆ The power cord or plug has become damaged or frayed.
 - ◆ Liquid has been spilled into the device.
 - ◆ The device has been exposed to rain or water.
 - ◆ The device has been dropped, or the cabinet has been damaged.
 - ◆ The device exhibits a distinct change in performance, indicating a need for service.
 - ◆ The device does not operate normally when the operating instructions are followed.
- ◆ Only adjust those controls that are covered in the operating instructions. Improper adjustment of other controls may result in damage that will require extensive work by a qualified technician to repair.

Consignes de sécurité

Général

- ◆ Ce produit est destiné exclusivement à une utilisation à l'intérieur.
- ◆ Veuillez lire la totalité de ces instructions. Conservez-les afin de pouvoir vous y référer ultérieurement.
- ◆ Respectez l'ensemble des avertissements et instructions inscrits sur l'appareil.
- ◆ Ne placez jamais l'unité sur une surface instable (chariot, pied, table, etc.). Si l'unité venait à tomber, elle serait gravement endommagée.
- ◆ N'utilisez pas l'unité à proximité de l'eau.
- ◆ Ne placez pas l'unité à proximité de ou sur des radiateurs ou bouches de chaleur.
- ◆ Le boîtier de l'unité est doté de fentes et d'ouvertures destinées à assurer une ventilation adéquate. Pour garantir un fonctionnement fiable et protéger l'unité contre les surchauffes, ces ouvertures ne doivent jamais être bloquées ou couvertes.
- ◆ L'unité ne doit jamais être placée sur une surface molle (lit, canapé, tapis, etc.) car ses ouvertures de ventilation se trouveraient bloquées. De même, l'unité ne doit pas être placée dans un meuble fermé à moins qu'une ventilation adaptée ne soit assurée.
- ◆ Ne renversez jamais de liquides de quelque sorte que ce soit sur l'unité.
- ◆ Débranchez l'unité de la prise murale avant de la nettoyer. N'utilisez pas de produits de nettoyage liquide ou sous forme d'aérosol. Utilisez un chiffon humide pour le nettoyage de l'unité.
- ◆ L'appareil doit être alimenté par le type de source indiqué sur l'étiquette. Si vous n'êtes pas sûr du type d'alimentation disponible, consultez votre revendeur ou le fournisseur local d'électricité.
- ◆ Afin de ne pas endommager votre installation, vérifiez que tous les périphériques sont correctement mis à la terre.
- ◆ L'unité est équipée d'une fiche de terre à trois fils. Il s'agit d'une fonction de sécurité. Si vous ne parvenez pas à insérer la fiche dans la prise murale, contactez votre électricité afin qu'il remplace cette dernière qui doit être obsolète. N'essayez pas d'aller à l'encontre de l'objectif de la fiche de terre. Respectez toujours les codes de câblage en vigueur dans votre région/pays.

- ♦ La prise murale doit être installée à proximité de l'équipement et doit être facile d'accès.
- ♦ Veillez à ce que rien ne repose sur le cordon d'alimentation ou les câbles. Acheminez le cordon d'alimentation et les câbles de sorte que personne ne puisse marcher ou trébucher dessus.
- ♦ Pour contribuer à protéger votre système contre les augmentations et diminutions soudaines et transitoires de puissance électrique, utilisez un parasurtenseur, un filtre de ligne ou un système d'alimentation sans coupure (UPS).
- ♦ Placez les câbles du système et les câbles d'alimentation avec précaution ; veillez à ce que rien ne repose sur aucun des câbles.
- ♦ Lors du branchement ou du débranchement à des blocs d'alimentation permettant la connexion à chaud, veuillez respecter les lignes directrices suivantes:
 - ♦ Installez le bloc d'alimentation avant de brancher le câble d'alimentation à celui-ci.
 - ♦ Débranchez le câble d'alimentation avant de retirer le bloc d'alimentation.
 - ♦ Si le système présente plusieurs sources d'alimentation, déconnectez le système de l'alimentation en débranchant tous les câbles d'alimentation des blocs d'alimentation.
- ♦ N'insérez jamais d'objets de quelque sorte que ce soit dans ou à travers les fentes du boîtier. Ils pourraient entrer en contact avec des points de tension dangereuse ou court-circuiter des pièces, entraînant ainsi un risque d'incendie ou de choc électrique.
- ♦ N'essayez pas de réparer l'unité vous-même. Confiez toute opération de réparation à du personnel qualifié.
- ♦ Si les conditions suivantes se produisent, débranchez l'unité de la prise murale et amenez-la à un technicien qualifié pour la faire réparer.
 - ♦ Le cordon d'alimentation ou la fiche ont été endommagés ou éraillés.
 - ♦ Du liquide a été renversé dans l'unité.
 - ♦ L'unité a été exposée à la pluie ou à l'eau.
 - ♦ L'unité est tombée ou le boîtier a été endommagé.
 - ♦ Les performances de l'unité sont visiblement altérées, ce qui indique la nécessité d'une réparation.
 - ♦ L'unité ne fonctionne pas normalement bien que les instructions d'utilisation soient respectées.

- ♦ N'utilisez que les commandes qui sont abordées dans le mode d'emploi. Le réglage incorrect d'autres commandes peut être à l'origine de dommages qui nécessiteront beaucoup de travail pour qu'un technicien qualifié puisse réparer l'unité.

Rack Mounting

- ◆ Before working on the rack, make sure that the stabilizers are secured to the rack, extended to the floor, and that the full weight of the rack rests on the floor. Install front and side stabilizers on a single rack or front stabilizers for joined multiple racks before working on the rack.
- ◆ Always load the rack from the bottom up, and load the heaviest item in the rack first.
- ◆ Make sure that the rack is level and stable before extending a device from the rack.
- ◆ Use caution when pressing the device rail release latches and sliding a device into or out of a rack; the slide rails can pinch your fingers.
- ◆ After a device is inserted into the rack, carefully extend the rail into a locking position, and then slide the device into the rack.
- ◆ Do not overload the AC supply branch circuit that provides power to the rack. The total rack load should not exceed 80 percent of the branch circuit rating.
- ◆ Make sure that all equipment used on the rack – including power strips and other electrical connectors – is properly grounded.
- ◆ Ensure that proper airflow is provided to devices in the rack.
- ◆ Ensure that the operating ambient temperature of the rack environment does not exceed the maximum ambient temperature specified for the equipment by the manufacturer
- ◆ Do not step on or stand on any device when servicing other devices in a rack.

The eco PDU's Main Power Cord

Use the power cord supplied with this package. If it becomes necessary to replace the cord supplied with this package, be sure to use a cord of at least the same standard as the one provided.



Securing the Power Cables

To secure the cables in the eco PDU's power outlets, use only the ATEN Lock-Your-Plug cable holders that have been specifically designed to work with the eco PDU. Using any other kind of cable securing device could be highly dangerous. Please contact your ATEN dealer for information about ATEN Lock-Your-Plugs.

Montage sur bâti

- ♦ Avant de travailler sur le bâti, assurez-vous que les stabilisateurs sont bien fixés sur le bâti, qu'ils sont étendus au sol et que tout le poids du bâti repose sur le sol. Installez les stabilisateurs avant et latéraux sur un même bâti ou bien les stabilisateurs avant si plusieurs bâtis sont réunis, avant de travailler sur le bâti.
- ♦ Chargez toujours le bâti de bas en haut et chargez l'élément le plus lourd en premier.
- ♦ Assurez-vous que le bâti est à niveau et qu'il est stable avant de sortir une unité du bâti.
- ♦ Agissez avec précaution lorsque vous appuyez sur les loquets de libération du rail d'unité et lorsque vous faites coulisser une unité dans et hors d'un bâti ; vous pourriez vous pincer les doigts dans les rails.
- ♦ Une fois qu'une unité a été insérée dans le bâti, étendez avec précaution le rail dans une position de verrouillage puis faites glisser l'unité dans le bâti.
- ♦ Ne surchargez pas le circuit de l'alimentation CA qui alimente le bâti. La charge totale du bâti ne doit pas dépasser 80 % de la capacité du circuit.
- ♦ Assurez-vous que tous les équipements utilisés sur le bâti, y-compris les multiprises et autres connecteurs électriques, sont correctement mis à la terre.
- ♦ Assurez-vous que les unités présentes dans le bâti bénéficie d'une circulation d'air suffisante.
- ♦ Assurez-vous que la température ambiante de fonctionnement de l'environnement du bâti ne dépasse pas la température ambiante maximale spécifiée pour l'équipement par le fabricant.
- ♦ Ne marchez sur aucun appareil lors de la maintenance d'autres appareils d'un bâti.

Le cordon d'alimentation principale de l'unité d'alimentation éco

Utilisez le câble d'alimentation fourni. Au cas où il s'avèrerait nécessaire de remplacer le cordon fourni avec l'appareil, veillez à utiliser un cordon respectant au minimum la même norme que celui d'origine.



Fixation des câbles d'alimentation

Pour fixer les câbles aux sorties d'alimentation de l'unité d'alimentation éco, utilisez uniquement les supports de câble Lock-Your-Plug d'ATEN qui ont été conçus spécialement pour être utilisés avec

l'unité d'alimentation éco. L'utilisation de tout autre type système de fixation de câble pourrait s'avérer très dangereuse. Veuillez contacter votre revendeur ATEN pour plus d'informations sur le support de câble ATEN Lok-U-Plug.

Technical Support

International

- ◆ For online technical support – including troubleshooting, documentation, and software updates: <http://eservice.aten.com>
- ◆ For telephone support, see *Telephone Support*, page iii

North America

Email Support		support@aten-usa.com
Online Technical Support	Troubleshooting Documentation Software Updates	http://www.aten-usa.com/support
Telephone Support		1-888-999-ATEN ext 4988

When you contact us, please have the following information ready beforehand:

- ◆ Product model number, serial number, and date of purchase.
- ◆ Your computer configuration, including operating system, revision level, expansion cards, and software.
- ◆ Any error messages displayed at the time the error occurred.
- ◆ The sequence of operations that led up to the error.
- ◆ Any other information you feel may be of help.

IP Address Determination

If you are an administrator logging in for the first time, you need to access the PN5212 / PN5320 in order to give it an IP address that users can connect to. There are two methods to choose from. In each case, your client computer must be on the same network segment as the PN5212 / PN5320. After you have connected and logged in you can give the device its fixed network address. (See *Network*, page 61.)

Method 1:

For computers running Windows, an IP address can be determined and/or assigned with the IP Installer utility. The utility can be obtained from the *Download* area of our web site. Look under *Driver/SW*, and the model of your device. After downloading the utility to your computer, do the following:

1. Unzip the contents of *IPInstaller.zip* to a directory on your hard drive.
2. Go to the directory that you unzipped the IPInstaller program to and run *IPInstaller.exe*. A dialog box similar to the one below appears:

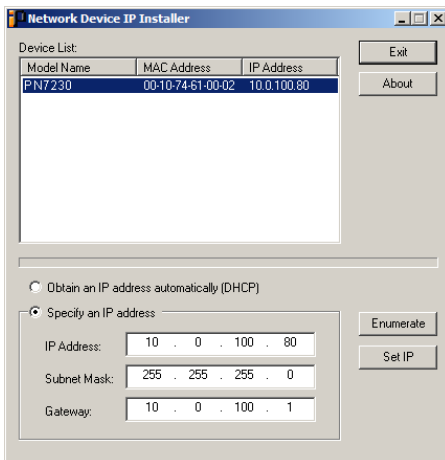

3. Select the device in the *Device List*.

Note: 1. If the list is empty, or your device doesn't appear, click **Enumerate** to refresh the Device List.

2. If there is more than one device in the list, use the MAC address to pick the one you want. The PN5212 / PN5320's MAC address is located on its bottom panel.
-

4. Select either *Obtain an IP address automatically (DHCP)*, or *Specify an IP address*. If you chose the latter, fill the IP Address, Subnet Mask, and Gateway fields with the information appropriate to your network.
5. Click **Set IP**.
6. After the IP address shows up in the Device List, click **Exit** to end the program.

Method 2:

1. Set your computer's IP address to 192.168.0.XXX
Where XXX represents any number or numbers except 60. (192.168.0.60) is the default address of the PN5212 / PN5320.)
2. Specify the device's default IP address (192.168.0.60) in your browser, and you will be able to connect.
3. Assign a fixed IP address for the device (see *Network*, page 61), that is suitable for the network segment that it resides on.
4. After you log out, reset your computer's IP address to its original value.
5. Once you have logged in, go to Network Settings to set up the permanent IP environment (see page 61).

Trusted Certificates

Overview

When you try to log in to the device from your browser, a Security Alert message appears to inform you that the device's certificate is not trusted, and asks if you want to proceed.

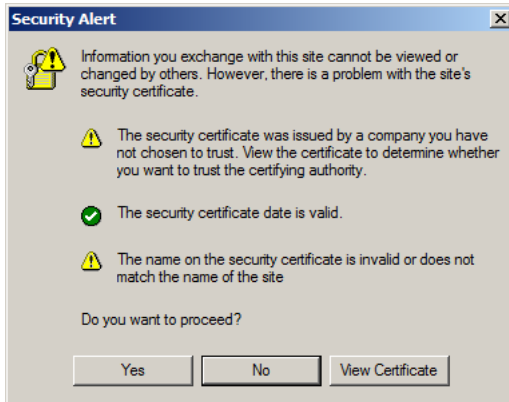

The certificate can be trusted, but the alert is triggered because the certificate's name is not found on Microsoft list of Trusted Authorities. You have two options: 1) you can ignore the warning and click **Yes** to go on; or 2) you can install the certificate and have it be recognized as trusted.

- ◆ If you are working on a computer at another location, accept the certificate for just this session by clicking **Yes**.
- ◆ If you are working at your own computer, install the certificate on your computer (see below for details). After the certificate is installed, it will be recognized as trusted.

Note: The security alert message will appear even after installing the certificate, but now the icon related to the first paragraph will be a check mark (indicating no alert) instead of the exclamation mark icon.

Installing the Certificate

To install the certificate, do the following:

1. In the *Security Alert* dialog box, click **View Certificate**. The *Certificate Information* dialog box appears:

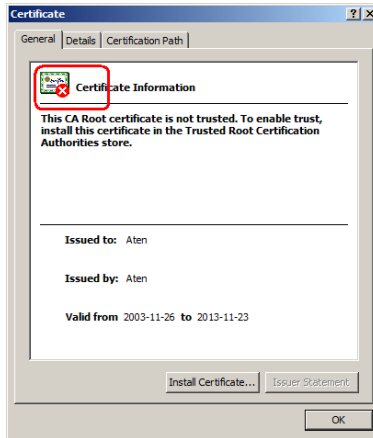

Note: There is a red and white X logo over the certificate to indicate that it is not trusted.

2. Click **Install Certificate**.
3. Follow the Installation Wizard to complete the installation. Unless you have a specific reason to choose otherwise, accept the default options.
4. When the Wizard presents a caution screen:

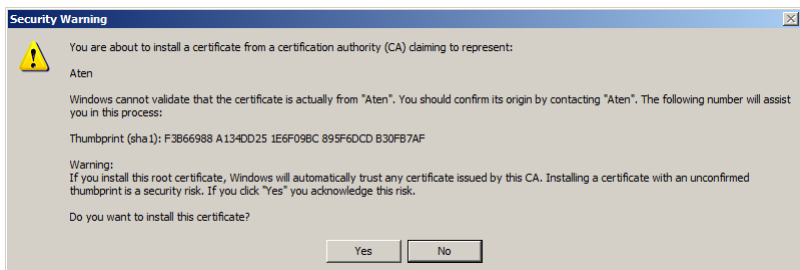

Click **Yes**.

- Next, click **Finish** to complete the installation; then click **OK** to close the dialog box.

Certificate Trusted

The certificate is now trusted:

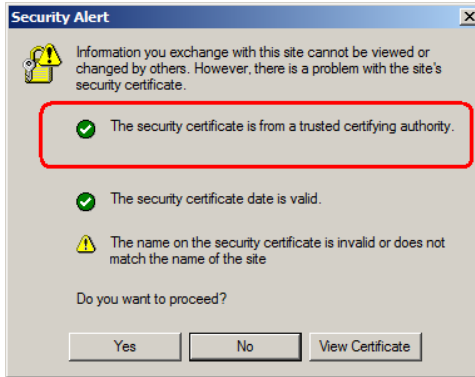

When you click *View Certificate*, you can see that the red and white X logo is no longer present – further indication that the certificate is trusted:

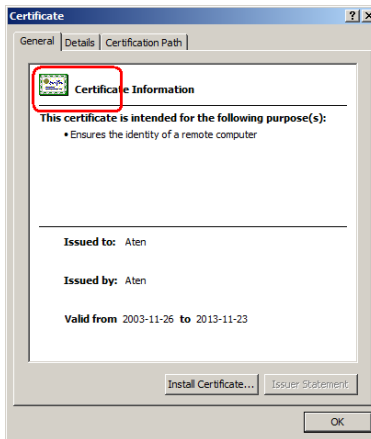

Mismatch Considerations

If the site name or IP address used for generating the certificate no longer matches the current address of the switch a mismatch warning occurs:

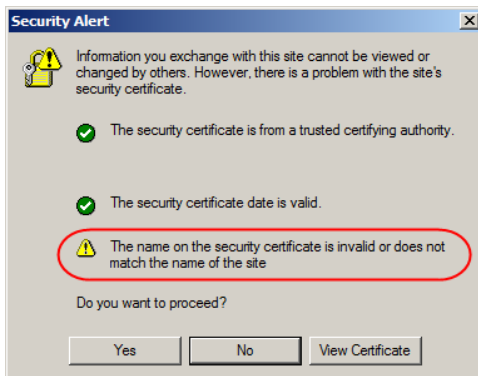

You can click **Yes** to go on, or you can disable mismatch checking.

To disable mismatch checking, do the following:

1. After the page you are logging in to comes up open the browser's Tools menu; Select *Internet Options* → *Advanced*.
2. Scroll to the bottom of the list and uncheck *Warn about trusted certificates*:

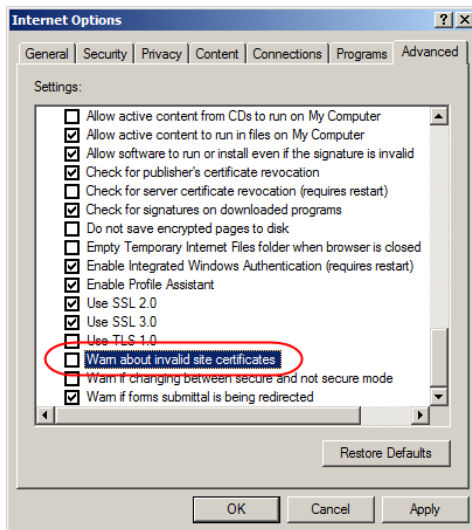

3. Click **OK**. The next time you run the browser the change will be in effect.

Self-Signed Private Certificates

If you wish to create your own self-signed encryption key and certificate, a free utility – `openssl.exe` – is available for download over the web at www.openssl.org. To create your private key and certificate do the following:

1. Go to the directory where you downloaded and extracted `openssl.exe` to.
2. Run `openssl.exe` with the following parameters:

```
openssl req -new -newkey rsa:1024 -days 3653 -nodes -x509  
-keyout CA.key -out CA.cer -config openssl.cnf
```

-
- Note:**
1. The command should be entered all on one line (i.e., do not press [Enter] until all the parameters have been keyed in).
 2. If there are spaces in the input, surround the entry in quotes (e.g., “ATEN International”).
-

To avoid having to input information during key generation the following additional parameters can be used:

```
/C /ST /L /O /OU /CN /emailAddress.
```

Examples

```
openssl req -new -newkey rsa:1024 -days 3653 -nodes -x509  
-keyout CA.key -out CA.cer -config openssl.cnf -subj  
/C=yourcountry/ST=yourstateorprovince/L=yourlocationor  
city/O=yourorganization/OU=yourorganizationalunit/  
CN=yourcommonname/emailAddress=name@yourcompany.com
```

```
openssl req -new -newkey rsa:1024 -days 3653 -nodes -x509  
-keyout CA.key -out CA.cer -config openssl.cnf -subj  
/C=CA/ST=BC/L=Richmond/O="ATEN International"/OU=ATEN  
/CN=ATEN/emailAddress=eservice@aten.com.tw
```

Importing the Files

After the `openssl.exe` program completes, two files – `CA.key` (the private key) and `CA.cer` (the self-signed SSL certificate) – are created in the directory that you ran the program from. These are the files that you upload in the *Private Certificate* panel of the Security page (see page 80).

Troubleshooting

Overview

Operation problems can be due to a variety of causes. The first step in solving them is to make sure that all cables are securely attached and seated completely in their sockets.

In addition, updating the product's firmware may solve problems that have been discovered and resolved since the prior version was released. If your product is not running the latest firmware version, we strongly recommend that you upgrade. See *Firmware Upgrade*, page 91, for upgrade details.

Problem 1:

On a safe shutdown and reboot operation, when rebooting, the computer stops at the logon screen and waits for a Username and Password instead of automatically logging on.

Solution:

The *Autologon* function hasn't been configured. Set it up as follows:

1. For Win NT, run *regedit.exe*; for Win 2000 or XP, run *regedt32*
2. Select the following:
HKEY_LOCAL_MACHINE\SOFTWARE\Microsoft\Windows NT\Current Version\Winlogon
3. Under the *Edit* menu, select **Add Value**.
4. Add the variables and values as shown in the table below:

Name	Value
DefaultDomainName	[domain name for this computer]
DefaultUserName	[user name for this computer]
DefaultPassword	[user password for this computer]
AutoAdminLogon	1

Note: Remove the brackets and replace the text inside the brackets with suitable values for yourself on this computer.

5. Close the Registry Editor.

Note: Make sure you have a real password (not blank) configured for logging on to your system.

Problem 2:

The computer has an older mainboard that doesn't support APM in the BIOS. What can I do to get Safe Shutdown and Reboot working?

Solution:

If you are running Windows 2000, XP, or Server 2003, you can do the following:

1. Open Control Panel → Power Options.
2. Open Properties → APM.
3. Enable Advanced Power Management support.

**Problem 3:**

I have enabled *Synchronize with NTP Server* in the Date / Time dialog box, but I am unable to obtain the date and time from an NTP server on the internet.

Solution:

Contact your MIS department and have them enable a port for the NTP server.

Problem 4:

Although my computers have been configured for a Safe Shutdown, some of them don't shut down.

Solution:

This may be due to the applications running on them putting up a dialog box asking if you want to save the information running on them before they close. Since you haven't provided an answer, the shutdown procedure doesn't continue to completion.

You can either change their shutdown behavior to *Kill the Power* - which is not a Safe Shutdown option, or use a product such as *KVM over the NET™* to access them remotely and answer the dialog box questions.

Problem 5:

When I log in, the browser generates a *CA Root certificate is not trusted*, or a *Certificate Error* response.

Solution:

The certificate's name is not found on Microsoft's list of Trusted Authorities. The certificate can be trusted, however. See *Trusted Certificates*, page 124, for details.

Problem 6:

System after AC Back doesn't work.

Solution:

Make sure *System after AC Back* is set to **On** (not *Last State*) in your computer's BIOS.

Problem 7:

After I rack mount my PN5212 / PN5320, the cables often come unplugged from the back of the unit.

Solution:

The connectors used on this device all conform to industry standard specifications. Nevertheless, if this problem occurs, we recommend using cable ties and cable bars to safely and securely route the cables. Contact your rack dealer for the cable routing hardware appropriate for your rack.

Problem 8:

The Log Server program does not run.

Solution:

The Log Server requires the Microsoft Jet OLEDB 4.0 driver in order to access the database.

This driver is automatically installed with Windows ME, 2000, and XP.

For Windows 98 and NT you will have to go to the Microsoft download site:

<http://www.microsoft.com/data/download.htm>

to retrieve the driver file:

MDAC 2.7 RTM Refresh (2.70.9001.0)

Since this driver is used in Windows Office Suite, an alternate method of obtaining it is to install Windows Office Suite. Once the driver file or Suite has been installed, the Log Server will run.

Administrator Login Failure

If you are unable to perform an Administrator login (because the Username and Password information has become corrupted, or you have forgotten it, for example), you can clear the login information with the following procedure:

1. Power off the PN5212 / PN5320 and remove its housing.
2. Short the jumper labeled J5.

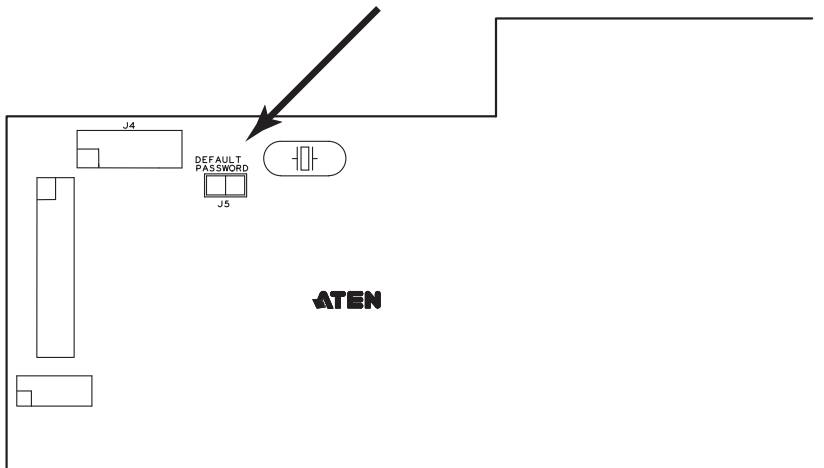

3. Power on the switch.
4. When the Link and 10/100Mbps LEDs flash, power off the switch.
5. Remove the jumper cap from J6.
6. Close the housing and start the PN5212 / PN5320 back up.
After you start back up, you can use the default Username and Password (see *First Time Setup*, page 15) to log in.

Specifications

Function		PN5212	PN5320	
Power Outlets	Direct	12	20	
	Max	192 (via Daisy Chain)	320 (via Daisy Chain)	
Connectors	Power Inlets	NEMA	1 x NEMA L5-20P	1 x NEMA L5-30P
		IEC	1 x IEC 60309	1 x IEC 60309
	Power Outlets	NEMA	12 x NEMA 5-15R	3 x NEMA 5-20R 17 x NEMA 5-15R
		IEC	12 x IEC320 C13	3 x IEC320 C19 17 x IEC320 C13
	PON In / Console		1 x RJ-45 (F)	
	PON Out		1 x RJ-45 (F)	
	LAN		1 x RJ-45 (F)	
LEDs	ID	1 x 2-digit 7-segment		
	Station	1 x Green		
	Readout	1 x 3-digit 7-segment		
	Current	1 x Green		
	Voltage	1 x Green		
	Power	1 x Green		
I/P Rating (Total Input)	NEMA (UL)	100-120V; 50/60Hz; 16A	100-120V; 50/60Hz; 24A	
	NEMA (PSE)	100-120V; 50/60Hz; 16A	100-120V; 50/60Hz; 24A	
	IEC	200-240V; 50/60Hz; 16A	200-240V; 50/60Hz; 32A	
Load Capacity	NEMA (UL)	120V; 50/60Hz; 1920W	120V; 50/60Hz; 2880W	
	NEMA (PSE)	120V; 50/60Hz; 1920W	120V; 50/60Hz; 2880W	
	IEC	230V; 50/60Hz; 3680W	230V; 50/60Hz; 7360W	
O/P Rating	Per Port	NEMA (UL)	100-120V; 50/60Hz; 12A	100-120V; 50/60Hz; 16A (x3) / 12A (x17)
		NEMA (PSE)	100-120V; 50/60Hz; 12A	100-120V; 50/60Hz; 16A (x3) / 12A (x17)
		IEC	200-240V; 50/60Hz; 10A	200-240V; 50/60Hz; 16A (x3) / 10A (x17)
	Total	NEMA (UL)	100-120V; 50/60Hz; 15A	100-120V; 50/60Hz; 23A
		NEMA (PSE)	100-120V; 50/60Hz; 15A	100-120V; 50/60Hz; 23A
		IEC	200-240V; 50/60Hz; 15A	200-240V; 50/60Hz; 31A
Power Consumption	NEMA (UL / PSE)	120V; 50/60Hz; 16W	120V; 50/60Hz; 22W	
	IEC	230V; 50/60Hz; 18W	230V; 50/60Hz; 26W	
Environment	Operating Temperature	0–50°C		
	Storage Temperature	-20–60°C		
	Humidity	0 ~ 80% RH Non-condensing		
Physical Properties	Housing	Metal		
	Weight	4.49 kg	5.68 kg	
	Dimensions (L x W x H)	6.42 x 5.46 x 134 cm	6.42 x 5.46 x 167.64 cm	

Limited Warranty

ATEN warrants this product against defects in material or workmanship for a period of one (1) year from the date of purchase. If this product proves to be defective, contact ATEN's support department for repair or replacement of your unit. ATEN will not issue a refund. Return requests can not be processed without the original proof of purchase.

When returning the product, you must ship the product in its original packaging or packaging that gives an equal degree of protection. Include your proof of purchase in the packaging and the RMA number clearly marked on the outside of the package.

This warranty becomes invalid if the factory-supplied serial number has been removed or altered on the product.

This warranty does not cover cosmetic damage or damage due to acts of God, accident, misuse, abuse, negligence or modification of any part of the product. This warranty does not cover damage due to improper operation or maintenance, connection to improper equipment, or attempted repair by anyone other than ATEN. This warranty does not cover products sold AS IS or WITH FAULTS.

IN NO EVENT SHALL ATEN'S LIABILITY EXCEED THE PRICE PAID FOR THE PRODUCT. FURTHER, ATEN SHALL NOT BE RESPONSIBLE FOR DIRECT, INDIRECT, SPECIAL, INCIDENTAL OR CONSEQUENTIAL DAMAGES RESULTING FROM THE USE OF THE PRODUCT, ITS ACCOMPANYING SOFTWARE, OR ITS DOCUMENTATION. ATEN SHALL NOT IN ANY WAY BE RESPONSIBLE FOR, WITHOUT LIMITATION, LOSS OF DATA, LOSS OF PROFITS, DOWNTIME, GOODWILL, DAMAGE OR REPLACEMENT OF EQUIPMENT OR PROPERTY, AND ANY EXPENSES FROM RECOVERY, PROGRAMMING, AND REPRODUCTION OF ANY PROGRAM OR DATA.

ATEN makes no warranty or representation, expressed, implied, or statutory with respect to its products, contents or use of this documentation and all accompanying software, and specifically disclaims its quality, performance, merchantability, or fitness for any particular purpose.

ATEN reserves the right to revise or update its product, software or documentation without obligation to notify any individual or entity of such revisions, or update.

For details about extended warranties, please contact one of our dedicated value added resellers.

This Page Intentionally Left Blank

A

- Access
 - Outlet Level, 36
 - Station Level, 35
- Access Ports, 61
- Adding Users, 46
- Administrator Login Failure, 133
- ANMS, 65

B

- Backup, 94
- Browser login, 19

C

- Configuration, 37
 - Outlet Level, 41
 - Station Level, 37
- Console Terminal Session, 105
- Corrupt Password, 133
- Creating Groups, 50
- Customization, 81

D

- Daisy Chaining, 13
- Date/Time, 82
- Date/Time Settings, 82
- Deleting groups, 52
- Deleting user accounts, 49
- Device Assignment, 57
- Device Information, 59
- Device Management, 59
 - Network, 61
- Device Permissions
 - assigning, 57, 58
- Download, 95

E

- End Session, 35
- Event Panel, 104

F

- Features, 2
- Filtering
 - IP, 77
 - MAC, 77
- Firmware Upgrade, 91
- Firmware upgrade recovery, 93
- Forgotten Password, 133

G

- Groups, 29, 31
 - assigning users, 53, 55
 - creating, 50
 - Deleting, 52
 - Managing, 50
 - Modifying, 52
 - removing users, 54, 56

H

- Hardware Setup, 9
- HyperTerminal, 105

I

- Installation
 - Daisy Chaining, 13
 - Single stage, 11
- IP address determination, 122
- IP Filtering, 77
- IP Installer, 62
- IPv4 Configuration, 63
- IPv6 Configuration, 64

L

- List Panel, 104
- Log, 85
 - Log Event List, 86
 - Notification Settings, 89
 - Save, 88
 - Search, 87
 - System Log, 85
- Log Server
 - Configure, 99
 - Event Panel, 104
 - Events, 100
 - Installation, 97
 - List Panel, 104
 - Main Screen, 103
 - Menu Bar, 99
 - Options, 102
 - Starting Up, 98
- Log server, 97
- Logging in
 - Browser, 19
- Login Failures, 81
- Login String, 77

M

- MAC Filtering, 77
- Main Page, 20
- Managing Groups, 50
- Managing Users, 46
- Manual Power Management, 25
- Modifying groups, 52
- Modifying user accounts, 49
- Mounting, 9

N

- Network, 61
- Network Configuration, 16
- Network Time, 83

O

- Online
 - Registration, iii
- OOB
 - Console Terminal Session, 105
- OOBC, 75
- Operation, 19
- Out of Band, 75
- Out Of Band Operation, 105, 109
- Outlet groups, 29, 31, 39
- Outlets, 27

P

- Port Selection
 - Sidebar, 24
- Power management
 - manual, 25
 - scheduled, 43
- Private Certificate, 80
- Private Certificates, 128
- PuTTY, 112

R

- Rack Mounting, 9
- Remote Terminal Operation, 109
- Requirements, 4
- Restore, 94
- RoHS, ii

S

- Safety Instructions
 - General, 113
 - Rack Mounting, 118
- Schedule, 43
- Scheduled Power Management, 43
- Security, 76
 - Login string, 77
- Self-signed certificates, 128
- Sessions, 35

Settings

Web refresh rate, 62

Setup

network configuration, 16

Sidebar, 24

Single stage installation, 11

SJ/T 11364-2006, ii

Specifications, 134

SSH

terminal session (Linux), 111

third party utility (Windows), 112

System after AC Back, 131

System Log, 85

T

Technical Support, 121

Telephone support, iii

Telnet, 109

Time settings, 82

Troubleshooting, 129

Trusted Certificates, 124

U

User interface

Page components, 21

User Management, 45

User Notice, iii

Users

Adding, 46

assigning to groups, 53, 55

Deleting, 49

Managing, 46

Modifying, 49

removing from groups, 54, 56

Users and Groups, 53

W

Web refresh rate, 62

Working Mode, 81